

F-86F SABRE

for **DCS**World



Flight manual



TABLE OF CONTENTS

Table of Contents

IMPORTANT NOTICE!	11
1. AIRCRAFT HISTORY	13
<i>Introduction</i>	13
1.1. BEGINNING OF JET AVIATION.....	13
1.2. DEVELOPMENT OF THE SABRE.....	17
1.3. THE F MODEL.....	21
1.4. THE F-86 IN THE KOREAN WAR.....	26
1.5. F-86 VARIANTS	35
2. MISSION OVERVIEW AND MAIN SPECIFICATIONS	47
2.1. MISSION OVERVIEW.....	47
2.2. MAIN SPECIFICATIONS.....	47
2.2.1. <i>Specifications table</i>	48
2.2.2. <i>Aircraft dimensions</i>	48
3. AIRCRAFT AND ENGINE DESIGN	51
3.1. AIRCRAFT DESIGN.....	51
3.1.1. <i>Fuselage</i>	51
3.1.2. <i>Wing</i>	54
3.1.3. <i>Flaps</i>	55
3.1.4. <i>Speed brakes</i>	56
3.1.5. <i>Empennage</i>	57
3.1.6. <i>Landing gear</i>	58
3.1.7. <i>Canopy</i>	59
<i>General description</i>	59
<i>Canopy Seal</i>	59
<i>Canopy Controls</i>	59
3.2. ENGINE AND RELATED SYSTEMS	63
3.2.1. <i>General design and layout</i>	63
3.2.2. <i>Engine scheme</i>	65
3.2.3. <i>Engine fuel automation system</i>	65

3.2.4.	<i>Main fuel automation system</i>	66
3.2.5.	<i>Emergency fuel automation system</i>	68
	<i>Fuel pressure controller</i>	68
3.2.6.	<i>Engine oil system</i>	68
3.2.7.	<i>Engine controls</i>	69
	<i>Fuel cut-off valve</i>	69
	<i>Engine master switch</i>	69
	<i>Engine throttle</i>	70
	<i>Engine monitoring instruments</i>	70
4.	COCKPIT	73
4.1.	AIRCRAFT AND ENGINE CONTROLS	74
4.1.1.	<i>Flight control stick</i>	75
4.1.2.	<i>Engine throttle</i>	76
4.1.3.	<i>Pedals</i>	76
4.2.	INSTRUMENT PANEL	77
4.2.1.	<i>Hydraulic pressure gauge</i>	79
4.2.2.	<i>Main instrument (three-phase) inverter failure warning light</i>	80
4.2.3.	<i>Hydraulic pressure gauge selector switch</i>	81
4.2.4.	<i>Both instrument (three-phase) inverter failure warning light</i>	82
4.2.5.	<i>Alternate-on warning light</i>	83
4.2.6.	<i>Main radar (single-phase) inverter failure warning light</i>	84
4.2.7.	<i>Directional indicator (slaved)</i>	85
4.2.8.	<i>Trim tab take-off position indicator light</i>	87
4.2.9.	<i>Directional indicator (slaved) fast slaving button</i>	88
4.2.10.	<i>Accelerometer</i>	90
4.2.11.	<i>Attitude indicator</i>	92
	<i>Attitude indicator operation</i>	94
4.2.12.	<i>LABS switch panel</i>	97
4.2.13.	<i>LABS dive-and-roll indicator</i>	98
4.2.14.	<i>Fire-warning light test button</i>	99
4.2.15.	<i>Oil pressure gauge</i>	100
4.2.16.	<i>Fire warning lights</i>	101
4.2.17.	<i>Tachometer</i>	102
4.2.18.	<i>EGT gauge</i>	103
4.2.19.	<i>Fuel flow meter</i>	104
4.2.20.	<i>Fuel quantity gauge</i>	105
4.2.21.	<i>Cabin pressure altimeter</i>	106

4.2.22.	Vertical velocity indicator	107
4.2.23.	Turn-and-slip indicator.....	108
4.2.24.	Altimeter.....	109
4.2.25.	Clock.....	112
4.2.26.	Loadmeter	114
4.2.27.	Generator (off) warning light.....	115
4.2.28.	Voltmeter.....	116
4.2.29.	Landing gear handle.....	117
4.2.30.	Radio compass indicator	118
4.2.31.	Airspeed indicator.....	119
4.2.32.	Landing gear emergency retraction button.....	121
4.2.33.	Mach number indicator	122
4.2.34.	Emergency fuel switch.....	124
4.3.	COCKPIT LEFT SIDE.....	125
4.4.	COCKPIT RIGHT SIDE.....	133
	<i>Right Forward Console</i>	135
4.5.	STAND-ALONE CONTROLS	136
5.	SYSTEMS	143
5.1.	FLIGHT CONTROL SYSTEM.....	143
	<i>Ailerons</i>	143
	<i>Boost hydraulic system</i>	143
	<i>Control stick</i>	143
	<i>Artificial-feel system</i>	144
	<i>Normal trim switch</i>	145
	<i>Lateral alternate trim switch</i>	146
	<i>Longitudinal alternate trim switch</i>	147
	<i>Take-off trim position indicator light</i>	148
	<i>Controllable horizontal tail</i>	148
	<i>Rudder pedals</i>	149
	<i>Rudder trim switch</i>	149
5.2.	POWER SUPPLY SYSTEM	151
	5.2.1. <i>General description</i>	151
	<i>Cockpit objects connected with electrical system:</i>	151
	<i>Scheme of aircraft power supply</i>	153
	<i>DC power supply system</i>	155
	<i>AC power supply system</i>	156
	<i>Ground power connection</i>	157
	<i>Circuit breakers</i>	157

5.2.2.	<i>Failures of power supply system components.....</i>	157
	<i>Generator failure.....</i>	157
	<i>Single-phase inverter failure.....</i>	158
	<i>Single three-phase inverter failure.....</i>	159
	<i>Failure of both three-phase inverters.....</i>	159
5.3.	FUEL SYSTEM.....	159
5.3.1.	<i>General scheme and description.....</i>	160
5.3.2.	<i>Cockpit objects related to fuel system.....</i>	162
5.3.3.	<i>Fuel management schedule.....</i>	164
5.3.4.	<i>Fuel tank usage control.....</i>	165
5.3.5.	<i>Amount of fuel uplift.....</i>	166
5.4.	HYDRAULIC SYSTEM.....	167
5.4.1.	<i>General description.....</i>	167
5.4.2.	<i>Cockpit objects related to hydraulic systems.....</i>	168
5.4.3.	<i>Utility hydraulic system and related systems.....</i>	173
	<i>Scheme of the utility hydraulic system.....</i>	173
	<i>Landing gear extension/retraction system.....</i>	174
	<i>Landing gear emergency-up button.....</i>	175
	<i>Gear Emergency Release Handle.....</i>	176
	<i>Nosewheel steering system.....</i>	176
5.4.4.	<i>Booster hydraulic systems.....</i>	177
	<i>Scheme of the booster hydraulic systems.....</i>	178
	<i>General description.....</i>	179
	<i>Normal booster hydraulic system.....</i>	179
	<i>Alternate booster hydraulic system.....</i>	179
	<i>Operation of the booster hydraulic systems.....</i>	179
5.5.	ENGINE ANTI-ICE AND PROTECTIVE SCREEN SYSTEMS.....	181
	<i>Engine anti-ice system.....</i>	181
	<i>Engine protective screens system.....</i>	182
5.6.	ENGINE FIRE INDICATION SYSTEM.....	182
5.7.	AIR PRESSURIZATION AND CONDITIONING SYSTEM.....	183
	<i>General scheme.....</i>	183
5.7.1.	<i>System operation.....</i>	184
5.8.	OXYGEN SYSTEM.....	185
	<i>Oxygen Regulator.....</i>	187
	<i>Oxygen System Operation.....</i>	188
	<i>Oxygen System Preflight Check.....</i>	189
5.9.	LIGHTING EQUIPMENT.....	189
5.9.1.	<i>Interior Lighting System.....</i>	189

5.9.2.	<i>Exterior Lighting System</i>	195
	<i>Landing light operation</i>	196
	<i>Description of cockpit objects related to exterior lighting system</i>	197
6.	WEAPONS	199
6.1.	OVERVIEW, STRUCTURE, AND VARIANTS	199
6.1.1.	<i>Overview and Structure</i>	199
	<i>Overview</i>	199
	<i>Structure</i>	199
6.1.2.	<i>F-86F-35 Weapons Variants, Racks, and Stores Release Subsystem</i>	200
	<i>Weapons Racks</i>	201
	<i>Stores Release Subsystem</i>	203
6.2.	GENERAL WEAPONS AND SIGHT CONTROLS	203
6.2.1.	<i>Weapons Control Center Pedestal</i>	203
6.3.	GUNNERY EQUIPMENT	207
6.3.1.	<i>General</i>	207
	<i>Guns and Sight Bore Sighting</i>	209
6.3.2.	<i>Gunnery Equipment</i>	209
6.4.	BOMBS AND BOMBING SYSTEMS.....	211
6.4.1.	<i>General</i>	211
6.4.2.	<i>Special Store (not simulated)</i>	214
6.4.3.	<i>Bombing Controls (General)</i>	214
	<i>Demolition Bomb Release Selector Switch</i>	215
	<i>Demolition Bomb Sequence Selector Switch</i>	216
	<i>Bomb-Arming Switch</i>	218
	<i>Fragmentation Bomb Selector Switch</i>	218
	<i>Bomb-Rocket Release Button</i>	219
	<i>Emergency Jettison Handle (Mechanical Jettisoning)</i>	219
	<i>Bomb-Rocket-Tank Jettison Button (Electric Jettisoning)</i>	220
	<i>Bombing Controls and A-4 Sight</i>	220
6.4.4.	<i>Low-Altitude Bombing System (LABS)</i>	221
	<i>LABS Switch Panel</i>	221
	<i>Dive-and-Roll Indicator</i>	222
6.4.5.	<i>MPC Bombing System</i>	223
	<i>Manual Pip Control Unit</i>	224
	<i>Bombing Altimeter</i>	226
	<i>Attitude Indicator</i>	227
6.5.	ROCKETS AND ROCKET SYSTEMS	227

6.5.1.	General.....	227
6.5.2.	Rocket Controls.....	229
	<i>Rocket Release Selector Switch</i>	229
	<i>Rocket Jettison Switch</i>	229
	<i>Rocket Intervalometer</i>	230
	<i>Rocket Fuze (Arming) Switch</i>	232
	<i>Bomb-Rocket Release Button</i>	233
6.6.	MISSILES	233
6.6.1.	General.....	233
6.6.2.	Missile Controls	235
	<i>Gun-Missile Selector Switch</i>	235
	<i>Missile Control Panel</i>	235
	<i>Control Stick Missile Trigger (Missile Launch Button)</i>	236
6.7.	A-4 TYPE SEMI-AUTOMATIC TELESCOPIC SIGHT	237
6.7.1.	<i>Sight Adjustment and Control Equipment</i>	240
	<i>Radar Target Selector Button</i>	240
	<i>Sight Electrical Caging Button</i>	241
	<i>Manual Ranging Control</i>	241
	<i>Sight Selector Unit</i>	242
	<i>Bomb-Target Wind Control Knob (no function in the simulation)</i>	244
6.7.2.	<i>Sight Operation Modes</i>	245
	<i>Using the Sight Without the Computer</i>	245
	<i>Using the Sight with the Computer</i>	246
6.8.	AN/APG-30 RADAR RANGING UNIT	250
6.9.	GUN CAMERA.....	251
6.10.	WEAPON RELATED COCKPIT OBJECTS.....	253
7.	RADIO COMMUNICATION AND RADIO ELECTRONIC EQUIPMENT	259
7.1.	UHF COMMAND RADIO — AN/ARC-27	259
	<i>Operation of AN/ARC-27 Command Radio</i>	260
7.2.	RADIO COMPASS (ADF) AN/ARN-6.....	261
	<i>Operation of RADIO COMPASS AN/ARN-6</i>	263
8.	FLIGHT AND RELATED PROCEDURES	266
8.1.	STARTING THE ENGINE.....	266
	<i>Preparation before engine start-up</i>	266
	<i>Start-up operation</i>	267
8.2.	SYSTEMS CHECK AFTER START-UP	270

<i>Ground Operation</i>	270
<i>System Ground Checks After Engine Start-up</i>	270
8.3. TAXIING	273
8.4. BEFORE TAKE-OFF.....	273
<i>General Items Check</i>	273
<i>Emergency Fuel System Check</i>	275
<i>Engine Check</i>	276
8.5. TAKE-OFF	276
8.6. CLIMB.....	278
<i>Procedure for determining climb parameters (example)</i>	280
8.7. APPROACH AND LANDING	281
8.8. TAXIING IN AND ENGINE SHUTDOWN	283
9. OPERATING LIMITATIONS	285
9.1. ENGINE LIMITATIONS	285
9.1.1. <i>Engine oil pressure limitations</i>	285
9.1.2. <i>Engine overtemperature</i>	286
9.2. AIRSPEED AND ACCELERATION LIMITATIONS	286
9.2.1. <i>Missile safe-launch speed</i>	286
9.2.2. <i>Landing gear and wing flap lowering speeds</i>	286
9.2.3. <i>Landing light extension speed</i>	286
9.2.4. <i>Canopy operating speed</i>	286
9.2.5. <i>Airspeed and acceleration limitations depending on the configuration</i>	286
9.2.6. <i>Prohibited maneuvers</i>	288
10. AIRCRAFT AERODYNAMIC PARTICULARS	290
10.1.1. <i>High speed</i>	290
10.1.2. <i>Maneuverability</i>	290
10.1.3. <i>Glide ratio</i>	291
10.1.4. <i>Exceeding allowed G-factor</i>	292
10.1.5. <i>Stall</i>	293
10.1.6. <i>Stall recovery</i>	294
10.1.7. <i>Spin</i>	295
10.1.8. <i>Recovery from the spin</i>	295
<i>Spin recovery procedure:</i>	295
11. COMBAT EMPLOYMENT	298
11.1. GUNNERY EMPLOYMENT	298

11.1.1.	<i>Firing Guns Using Radar</i>	<i>298</i>
	<i>Procedure for firing the guns using radar:.....</i>	<i>298</i>
11.1.2.	<i>Firing Guns Without Radar</i>	<i>300</i>
11.2.	BOMB EMPLOYMENT	301
11.2.1.	<i>Bomb employment using sight without MPC.....</i>	<i>302</i>
	<i>Procedure</i>	<i>302</i>
11.2.2.	<i>Bomb employment using LABS</i>	<i>305</i>
	<i>Procedure</i>	<i>305</i>
11.2.3.	<i>Bomb employment using sight and MPC</i>	<i>308</i>
	<i>Procedure</i>	<i>309</i>
11.2.4.	<i>Bomb employment with mixed rocket and bomb load-out.</i>	<i>313</i>
11.2.5.	<i>Bomb Emergency Release.....</i>	<i>313</i>
11.3.	ROCKET EMPLOYMENT	314
11.3.1.	<i>Rocket employment using sight.....</i>	<i>314</i>
11.3.2.	<i>Rocket employment with mixed rocket and bomb load-out</i>	<i>318</i>
11.4.	MISSILE EMPLOYMENT	318
11.4.1.	<i>GAR-8 Air-to-Air missiles employment.....</i>	<i>318</i>
11.5.	TACTICS OF THE FIRST JET FIGHTERS	321
11.5.1.	<i>Fighter Formation.....</i>	<i>321</i>
11.5.2.	<i>Changes in the function of ground-based command posts.</i>	<i>321</i>
11.5.3.	<i>Main tasks of ground-based command posts included the following:</i>	<i>322</i>
12.	EMERGENCY PROCEDURES	324
12.1.	ENGINE FAILURE	324
12.1.1.	<i>Engine failure during flight at low altitude</i>	<i>324</i>
12.1.2.	<i>Engine failure after take-off</i>	<i>325</i>
12.1.3.	<i>Engine power loss during flight – below 25,000 ft</i>	<i>325</i>
12.1.4.	<i>Engine air start</i>	<i>325</i>
	<i>Immediate Restart.....</i>	<i>325</i>
	<i>Air Start.....</i>	<i>326</i>
12.1.5.	<i>Maximum glide.....</i>	<i>327</i>
12.2.	FIRE	327
12.2.1.	<i>Engine fire during take-off</i>	<i>327</i>
12.2.2.	<i>Fire while airborne.....</i>	<i>327</i>
12.2.3.	<i>Engine fire during flight</i>	<i>328</i>
12.3.	FLIGHT CONTROL HYDRAULIC SYSTEM FAILURE	328
12.3.1.	<i>Failure of the normal system.....</i>	<i>328</i>
12.3.2.	<i>Failure of both hydraulic systems</i>	<i>329</i>

12.4.	LANDING GEAR EMERGENCY OPERATION	330
	<i>Emergency Lowering</i>	330
12.5.	TRIM FAILURE	330
13.	HOW TO PLAY	332
13.1.	GENERAL INFORMATION	332
	<i>Interaction between player and virtual cockpit</i>	333
13.2.	BUILT-IN MISSIONS	333
	<i>Procedure for starting a built-in mission:</i>	333
13.3.	CONTROLLING THE AIRPLANE AND VARIOUS COCKPIT OBJECTS.....	336
13.3.1.	<i>Controlling the airplane with the joystick</i>	337
13.3.2.	<i>Controlling the airplane with the keyboard</i>	337
13.3.3.	<i>Interacting with cockpit objects with the mouse</i>	338
13.4.	CONTROLLING VIRTUAL PILOT HEAD POSITION AND VIEWS IN THE 6DOF COCKPIT 339	
13.4.1.	<i>Controlling virtual pilot head position in the 6DOF cockpit.</i>	339
	<i>Head movement, rotation, and zooming with keyboard and mouse ...</i>	340
13.4.2.	<i>Controlling views in the 6DOF cockpit</i>	343
13.5.	SPECIAL GAME SETTINGS	344
13.6.	INFORMATIONAL HELP TO THE PLAYER	346
13.6.1.	<i>Kneeboard</i>	346
	<i>ABBREVIATIONS AND TERMS</i>	348
14.	ABBREVIATIONS AND TERMS	349
	<i>THE METRIC SYSTEM AND</i>	357
	<i>EQUIVALENTS, CONVERSION FACTORS</i>	357
15.	THE METRIC SYSTEM AND EQUIVALENTS, CONVERSION FACTORS	358
15.1.1.	<i>The Metric System and Equivalents</i>	358
15.1.2.	<i>Approximate Conversion Factors</i>	359
	<i>DEVELOPERS</i>	361
16.	DEVELOPERS	362
	<i>BELSIMTEK</i>	362
	<i>MANAGEMENT</i>	362
	<i>PROGRAMMERS</i>	362
	<i>DESIGNERS</i>	362
	<i>SCIENCE SUPPORT</i>	363



TESTER STAFF..... 363
TRAINING..... 363
SPECIAL THANKS..... 363
BIBLIOGRAPHY AND SOURCES 364

17. BIBLIOGRAPHY AND SOURCES..... 365

Important notice!

This document includes the history of the airplane and provides brief descriptions of the aircraft's structural elements, systems, equipment and their corresponding cockpit controls.

Note that the information about individual systems is not concentrated in a single section, but scattered all over the document, i.e. elements of the aircraft are described in one section of this manual while the controls and features of operation are described in another section. For example, the description of the armament system is divided in two parts: in the first part, the designation, composition and functional features are described. In the second part, information on how to use each weapon system for its corresponding tasks is given. This approach is used due to multiple interconnections between the elements of the aircraft. For this reason, a system is first described as an element of aircraft design and then as an object of cockpit control.

If you are willing to get a deeper understanding of the design and features of the F-86F, we recommend that you carefully study all the available references.

Notes in small print are more detailed explanations for users who want to gain a deeper understanding of a mechanism, system or equipment.

In case you want to jump right into the action and start with combat employment while studying the airplane gradually "on the go", you can begin by reading the [FLIGHT](#) or [COMBAT EMPLOYMENT](#) chapters first.

For convenience, this manual contains [cross-references](#) and [hyperlinks](#) that connect all references to the same object throughout the text, or when it is necessary to describe the operation of an object in conjunction with another one. To follow a hyperlink in this PDF document, click it with the left mouse button. Use the keys [\[Alt + <-\]](#) (arrow left) or [\[Alt + ->\]](#) (arrow right) to return.

If you are a new player just getting acquainted with DCS World, it is recommended to visit the [HOW TO PLAY](#) section first.

F-86E Sabre

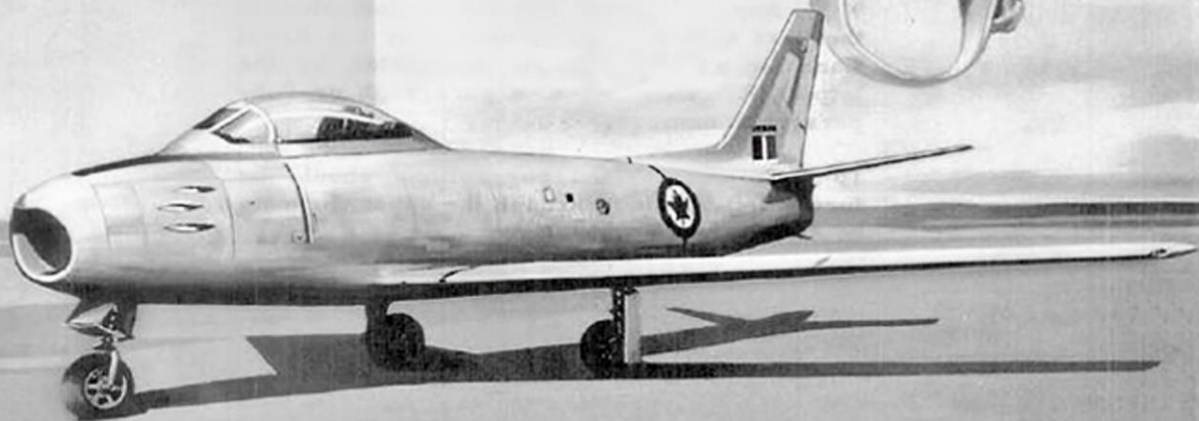
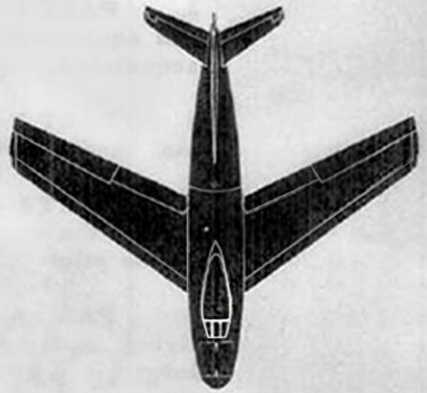

1

AIRCRAFT HISTORY

1. AIRCRAFT HISTORY

Introduction

Throughout aviation history only a few aircraft were entitled to be called legends. The F-86 Sabre is among them.

The F-86 Sabre is an American swept-wing jet fighter. Developed by North American Aviation in the late 1940s, it entered service in 1948 and was employed in several wars and conflicts (the Korean War of 1950-1953, the Taiwan crisis of 1958, and the Indo-Pakistani conflict of 1965). The most-produced U.S. jet fighter in history, it took part in air-to-air combat, strike missions and surveillance. In addition to these roles, the F-86F Sabre was also used as a target drone and as a test bed for systems and weaponry. A total of more than 9,000 airframes of all versions were built.

DCS: F-86F Sabre is a virtual equivalent of the F-86F – the most-produced version of the F-86 Sabre. This simulation of the F-86F-35, an advanced version of the F-86F, will allow you to fulfill exciting combat missions or simply enjoy flying a legend of a fighter.

1.1. Beginning of jet aviation

The history of jet fighters started with the beginning of World War II. The first jet fighter used by the Allies was the UK Gloster Meteor F.1.



Figure 1.1. Pilot going aboard the Meteor F.1 (1944)

The Meteor F.1 had two turbojet engines and attained a speed of up to 716 km/h. The maximum speed of most piston fighters of that time did not exceed 640 km/h. The speed of the Meteor, huge for that time, was its critical advantage when engaging the German pulsejet-powered cruise missile V-1 equipped with an automatic guidance system. These missiles were used against

area targets on the British Islands, and the role of the Meteors as jet air defense cannot be overstated.

At that time, Germany was ahead of England in jet aviation. At the beginning of World War II, Germany had already begun producing a turbojet fighter in the form of the very progressive Me-262.



Figure 1.2. The first Luftwaffe jet in a fighter-bomber modification, Me-262A-2 Schwalbe (Swallow)

The Me-262 was powered by two jet engines with an axial-flow compressor. Good aerodynamic design of the wing and fuselage allowed it to attain a better speed than that of the Meteor. In fact, the appearance of the Me-262 fighters forced the Allies to reconsider the advantages of this new technology.

While England and Germany were experimenting with jets, the U.S. was mostly concentrated on improving piston engines. But in 1943 the situation changed when development of the F-80 Shooting Star, the first American-production jet fighter, began. Had World War II lasted a while longer, the F-80 likely would have seen jet-to-jet air combat in the skies over Europe.



Figure 1.3. F-80A fighter "Shooting Star"

Republic Aviation further improved jet fighter design with the F-84 Thunderjet, the first jet fighter to enter service in many countries. It had an improved aerodynamic fuselage design and a more powerful engine, but – like the F-80 – had a straight wing which prevented it from attaining higher speeds.



Figure 1.4. F-84 Thunderjet

Using the amassed industry experience as well as its own research, North American Aviation developed the F-86 Sabre, a revolutionary design with a swept wing and empennage.



Figure 1.5. F-86 Sabre in flight

The "Sabre" – a name which invokes images of the cold, deadly weapon of cavalries past – is one of the best known American jet fighters of the past century.



Figure 1.6. F-86 Sabre with external fuel tanks

It became known not only for the Korean War that started its combat history, but also for its huge production volumes – a total of almost 9,000 Sabrejets were manufactured in twenty variants with five different engines. The last F-86 officially retired in 1993 having set a record for long service life. Today, F-86 Sabrejets are in private collections with some even still flying.

1.2. Development of the Sabre

The history of the F-86 started in autumn 1944 with the North American NA-134 naval fighter. The NA-134 had a low straight wing and a short barrel-shaped fuselage. The TG180 turbojet engine with a thrust of 1,820 kgf gave the 6,532 kg fighter a maximum speed of 872 km/h. In addition, the NA-134 had a rate of climb of 23.8 m/s at sea level, and an operating ceiling of 14,500 m.



Figure 1.7. North American NA-134

With these performances, this aircraft became a serious opponent in the air. But the required speed of 600 mph (960 km/h) was not achieved. The work continued. More than 1,200 schemes were studied by design engineers, and finally the right layout for the aircraft was found. In May 1945, North American received an order from the United States Army Air Forces (USAAF) for three experimental NA-140s, each given the XP-86 designation. However, the aircraft still would not be able to meet the required top speed, so the management considered canceling the program. The main distinctions of the NA-140 from the NA-134 were an extended fuselage and a new wing design. The shape of the air intake was also modified, but the empennage was kept unchanged. Besides aerodynamic modifications, some special features arose from the project that had not been used on American fighters before – a pressurized cockpit and boosters in the pitch and roll control channels.



Figure 1.8. XP-86 prototype

The XP-86, an unarmed prototype, was equipped with the Chevrolet J35-C-3 engine that produced 1,816 kgf of thrust. In August 1945, aerodynamicist Raymond Rayet suggested testing a swept-wing XP-86 model in the wind tunnel. The tests started in September and immediately showed a lower drag and a larger maximum airspeed. In November 1945, the project was approved. The wing received a 35° sweepback and slats were installed. The slats would automatically extend at 130 knots and retract at 290 knots solving the problem of low-speed instability.

The first swept-wing XP-86 had its first flight on October 1, 1947.



Figure 1.9. Prototype XP-86 in flight

During several speedy diving maneuvers with the XP-86, North American test pilot George Welch reported unusual oscillations on the airspeed indicator and altimeter. Experts assumed the aircraft was at supersonic speed at that moment, but they were not fully sure. On November 13, 1947 (officially announced on April 26, 1948), the ground tracking station reported George Welch flying at $M=1.02$. The XP-86 could exceed the speed of sound in a dive, demonstrating quite satisfactory controllability at high altitudes though with a slight nose-up trend. But below 7,600 m, the aircraft started excessive rotation about its longitudinal axis which compelled the pilot to lower the speed.

The project began active development and was so successful that in December 1947, the U.S. Air Force signed a contract for the F-86A (company designation NA-151) fitted with the General Electric J47-GE-7 engine, and – later on – with the improved J47-GE-13 engine.



Figure 1.10. F-86A-5 with gun port caps and external fuel tanks

The aircraft received an armament of six 12.7 mm machine guns. Also, instead of jettisonable tanks, it could carry external stores. These usually took the form of 45 kg, 220 kg, 454 kg bombs, 375 kg tanks with napalm, or 220 kg expendable bomb cells. Tracks for eight unguided rockets could also be installed under each wing.



Figure 1.11. F-86 with armament displayed on ground

1.3. The F model

The main production variant of the Sabrejet was the F-86F. The key distinction of this model was the new J47-GE-27 engine that gave it 2,680 kgf of thrust.

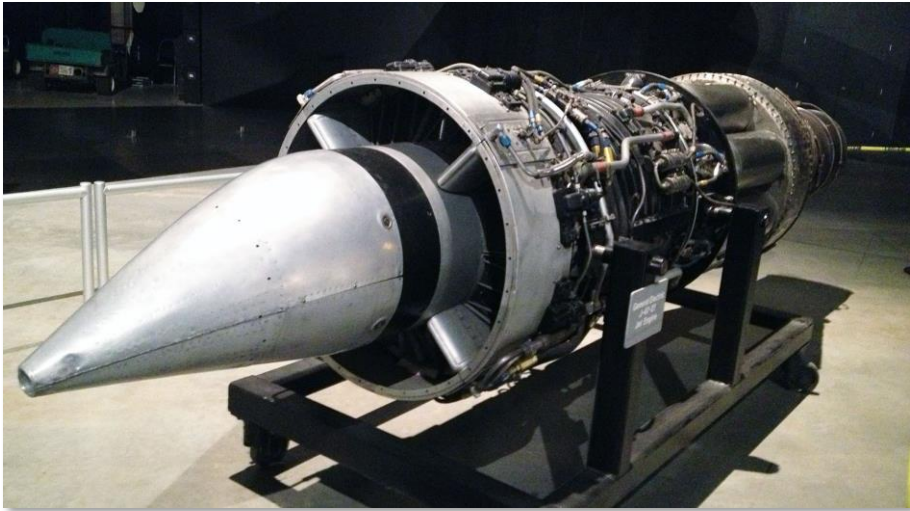

Figure 1.12. J47-GE-27 engine

Work on the F-86F Sabre started in July 1950. An order for 109 aircraft was signed in April 1951. In June, the order was extended to 360 aircraft. F-86F production took place at two manufacturing plants: in Inglewood where Sabrejets were built and at the facility in Columbus that had been preserved from the end of World War II.

With the more powerful J47-GE-27 engine, the new model had significantly better performance characteristics. The top speed of the F-86F increased to 1,107 km/h at sea level and to 965 km/h at an altitude of 10,670 m. The operating ceiling also increased to 14,500 m. Finally, a better engine efficiency extended the fighter's combat radius to 690 km.

The F-86F retained the fully automatic slats but they now extended at 217 km/h. Also retained were the six M3 heavy machine guns in the forward part of the fuselage with a firing rate of 1,100 rounds per minute and a stock of 300 bullets.

The first F-86Fs were assembled in Inglewood. Deliveries of the J47-GE-27 jet engine started in spring 1952, and then, on March 19, the first F-86F-1 airframe

out of 78 was built. In June, the F-86F-5 modification came out that could carry external fuel tanks of 760-liter capacity instead of the previous 454 liters. This extended the fighter's combat radius to 740 km.

The development of the next variant of the F-86F Sabre started in October 1951. The project was a fighter-bomber modification designated NA-191. On each wing, the aircraft had two pylons instead of one. Previous Sabrejet modifications were not very suitable for bombing because of their short range if the fuel tanks were replaced with bombs or missiles. With four attachments for external stores, this aircraft could carry 454-liter tanks or 454 kg bombs on the inner pylons, and 760-liter tanks on the outer pylons. With the maximum fuel reserve (i.e. with two 760-liter and two 454-liter tanks), the ferry range reached 2,560 km while the combat radius increased to 910 km.

In August 1952, Inglewood signed a contract for 907 NA-191s. The first fighter-bomber Sabrejet was designated F-86F-30 and started coming off the assembly line in Inglewood in October 1952. Starting in January 1953, Columbus started manufacturing a similar modification designated the F-86F-25.

To improve performance characteristics, three aircraft were used for testing the wing without leading edge slats in August 1952. The wing chord on these aircraft was 150 mm longer at the root and 75 mm longer at the wing tip. This increased the overall wing area from 26.78 m² to 28.12 m², which also increased the internal fuel capacity from 1,646 liters to 1,911 liters.

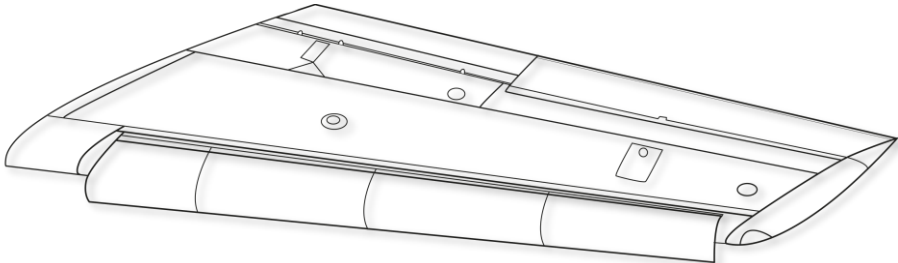

Figure 1.13. Slatted wing of F-86

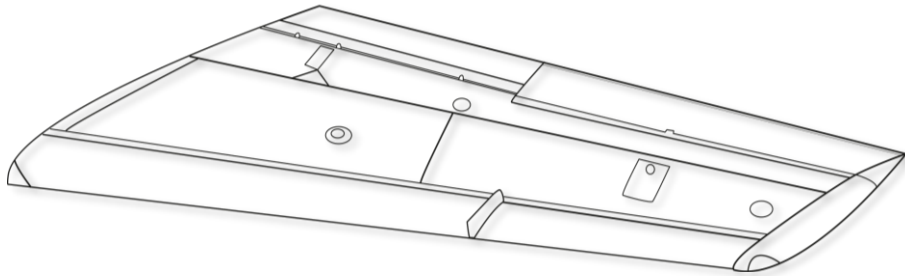

Figure 1.14. "6-3" wing of F-86F without slat

The wing had a fin on the upper surface that prevented airflow from spreading over the wing area. The new wing (known as a "6-3" wing because the wing chord was extended six inches at the root and three inches at the tip) notably improved the fighter's combat characteristics. The airspeed near the ground increased from 1,100 to 1,112 km/h, while the airspeed at 10,680 m increased from 966 to 973 km/h. The mission range was also extended and the maneuverability at high airspeeds and altitudes improved. Hence, the "6-3" wing became standard for all subsequent "F" series Sabrejets.



Figure 1.15. F-86F with "6-3" wing

In the early 1950s, a nuclear weapon was considered a super weapon that could guarantee a quick victory in a war. Nuclear bombs were designed to be delivered to the target by any means. The first fighter-bomber modification capable of carrying a nuclear bomb was the F-86F-35.

In 1952, the manufacturing facility in Inglewood (California) started the assembly of the F-86F-35 (NA-202(191)). A total of 157 (263) airframes of this modification were built. A reduced-weight Mk.12 bomb weighing 545 kg and

having a yield of 12-14 kt was specially designed for the fighter-bomber. It was attached under the left wing while the right wing took a 454-liter external fuel tank.



Figure 1.16. Mk.12 bomb

Dive release of a nuclear bomb was impossible as it would destroy the carrier aircraft. Thus, the F-86F-35 was equipped with the [Low Altitude Bombing System \(LABS\)](#) that allowed a pitch-up or half-loop bombing delivery. The pilot approached a target at a low altitude and dropped the bomb on the ascending maneuver. Finishing the half-loop with a simultaneous climb, the aircraft escaped the blast wave of the nuclear explosion.



Figure 1.17. F-86F-35 fighter with a Mk.12 bomb mock-up

The aircraft could also carry ordinary armament such as bombs weighing up to 454 kg, 340 kg tanks with napalm or up to eight 127 mm unguided HVAR (High-Velocity Aircraft Rocket).



Figure 1.18. Unguided 127 mm HVAR (High-Velocity Aircraft Rocket)



Figure 1.19. Shooting 127 mm unguided HVAR

1.4. The F-86 in the Korean War

The Korean War started on June 25, 1950. On June 27, the Allied air forces started bombing enemy troops. The Allies quickly achieved air domination as the opponent had only piston aircraft.

On November 1, 1950, a group of B-26 bombers escorted by P-51 fighters was bombing the airfield in Sinuidzu. Suddenly, six swept-wing fighters appeared from the riverside and attacked the B-26s. The bombers, protected by their escorts, escaped the attack and were able to return to their home base. Nonetheless, this event marked the introduction of a dangerous new player into

the Korean War – the MiG-15, whose role in the conflict could not be overstated.



Figure 1.20. B-29 dropping 226 kg bombs (1950)

On November 8, the Fourth wing comprised of F-86A fighters based in Delaware was ordered to go to Korea. Most pilots from this wing were experienced World War II veterans – their combat victories totaled to 1,000 downed aircraft. The fighters were put on ships and arrived in Japan by the middle of December. From there, they were transported to the Korean airfield Kimpo.

The first combat mission of the F-86A and also the world's first encounter between two swept-wing jet fighters occurred on December 17. Wing commander Bruce Hinton declared a victory over one of four encountered MiG-15s. On December 22, the MiGs killed the first Sabrejet, but later that day six victories over MiGs were announced.

According to 4 WIF command, before the end of December, Sabres performed 234 combat missions, 76 of which involved air-to-air combat that resulted in eight victories and one loss.

The MiG-15 was superior to the F-86A in altitude characteristics: it had a higher rate of climb, higher operating ceiling and better agility at high altitudes. These advantages allowed it to leave a fight at any moment. At the same time, the F-86A pilots used the advantages of their aircraft: more accurate guns, slightly better performance at low altitudes, and quick acceleration in a dive. To be able to use these advantages in a fight, Sabre pilots tried to draw the opponent to lower altitudes.

During the war, the F-86 Sabre received further upgrades and improvements. Gradually, the F-86E with an advanced flight control system replaced the previous models. This model received an artificial feel on the control stick. With boosters in the pitch and roll control channels, it allowed the pilot to feel the force applied to the stick when maneuvering. The first new Sabrejets were sent to the 33rd wing comprised of interceptor fighters at Otis airfield in Massachusetts. In June 1951, the F-86Es were transported to Korea. The new fighters joined the battle in September, while the old F-86As were transferred to the US Air National Guard units. On October 22, 1951, 75 F-86Es were sent to Japan before being transported to 51st wing based in Suwon to replace the F-80s.



Figure 1.21. 51st FIG "Checkertails" at K-13 air base (Suwon, South Korea) being prepared for a mission

The first F-86Fs (an upgraded version of the F-86E) were delivered to Korea in June-July 1952. A distinctive feature of this modification was the more powerful J47-GE-27 engine. They were put into service with 39th squadron of 51st wing. Two months later, they were also provided to 335th squadron of 4th wing. The F-86F with the "6-3" wing had a better airspeed than the MiG-15 at all altitudes up to its operating ceiling of 14,335 m. Additionally, it had improved maneuverability and a rate of climb almost equal to that of the MiG-15. As a result of these improved flight characteristics, pilots felt more confident in air combat.

With the arrival of the F-86Fs, the efficiency of Allied combat actions drastically improved. Before the end of the year, the 335th squadron declared 81 victories, while the other two squadrons (still flying F-86Es) had only 41. Hence, it was decided to ship all available "F" versions in the U.S. to Korea and distribute them uniformly among the military bases.

It was with the "6-3" wing that the F-86F achieved its most important victories in the Korean War. Between the 8th and the 31st of May 1953, these aircraft downed 56 MiGs while having lost only one Sabre. This score was not beaten until the beginning of the 1980s when Israeli pilots with F-15s and F-16s in the Bekaa valley downed 80 Syrian fighters without any losses of their own.

The F-86F often flew together with the F-86E. Usually, the F-86F stayed at an altitude of 12,000 m while the E stayed lower serving as protection for the bombers. On June 20, 1953, the F-86F pilots announced 16 victories – the best one-day result for the war.

It was at this time that the famous "MiG Alley" was born. This term referred to the region in the north-western part of North Korea, south of the Yalu Jiang River, which separates North Korea and China. This area was controlled by the MiGs and it was dangerous for the Allies to fly there. All air combat over MiG Alley was short as the great distance from the Sabres' home bases limited their time in this region.



Figure 1.22. Location of the "MiG Alley"

The first F-86F-30 fighter-bombers arrived in Korea on January 28, 1953, and were assigned to the 18th wing at Osana airfield. The first combat mission to the Yalu region occurred on February 25 resulting in the wing's first MiG-15 kill. By the end of March, the same models were introduced to the 12th squadron and 2nd squadron of the South African Air Force. The latter performed 1,427 combat missions with Sabres and lost only two aircraft to enemy fire.

The Korean War ended on July 27, 1953. The last fight between Sabres and MiG-15s took place on July 22 where Lieutenant S. Yang declared the first and only air combat victory of his wing, the 31st. The last aircraft downed by a Sabre in Korea was an Il-12 on July 27, 1953. In that instance, the F-86F-30 was flown by Captain R. Perry. By this time, Korea had 297 Sabres including 132 fighter-bombers. And throughout the course of the war, 39 American Sabre pilots had become aces.

All the advantages of the Sabre were revealed by the Korean War, a conflict with which it will always be associated.



Figure 1.23. F-86F fighters in the sky over Korea



Figure 1.24. F-86E with victory marks at Kimpo Air Base



Figure 1.25. F-86G from 67 FBS



Figure 1.26. F-86F displaying bomb load variants



Figure 1.26. F-86F from 25 FIS at Suwon Air Base (spring 1953)



Figure 1.27. Stock of F-86 fuel tanks on airfield



Figure 1.28. Fighters from 16 FIS on airfield



Figure 1.29. Pre-flight preparation of F-86F from 16 FIS



Figure 1.27. Take-off

1.5. F-86 variants

Developer: North American Aviation Inc. (Inglewood, California)

From development versions to final versions, including all variants and modifications, a total of over 9,000 F-86s were built, 6,300 of them in the USA.

The F-86 was also manufactured under license in the following countries:

- Canada (1,815 aircraft in Canadair Ltd, Carterville, Montreal, Quebec: 790 CL-13, 370 CL-13A, 655 CL-13B),
- Australia (CAC – Commonwealth Aircraft Corp., Melbourne: 1 CA-26 in 1952 and 111 CA-27 Avon Sabre in 1953-1961 delivered to Malaysia and Indonesia),
- Italy (221 F-86K: Fiat, Turin),
- Japan (300 F-86F-40 in 1956-61 from subassemblies received from the NAA: Mitsubishi Heavy Industries Ltd, Nagoya).

Table 1.1

Original designation	Military designation	Engine type	Start of flight tests	Year of entering service	Note
NA-134	XFJ-1 Fury	J35-GE-2	1946	-	Naval fighter. Prototype, 3 airframes (BuNo. 39053/39055) in 1946, North American Inglewood (California). With a straight folding wing, jet engine of 1,733 kgf thrust.
NA-135	FJ-1 Fury	Allison J35-A-2	1947	1948	With a jet engine of 1,814 kgf thrust, 6 12 mm Browning guns, wing tip tanks. Series of 1947-1948 of North American, Inglewood (California), 30 airframes (BuNo. 120342 / 120371, of 100 ordered).
NA-140	XP-86	Allison J35-GE-2	-	-	FJ-1 Fury variant for Air Forces, 1946. Straight wing.
	XP-86	Allison J35-C-3	1947	-	Prototype, 3 airframes (45-59597/45-59599) in 1947 by North American Inglewood (California). With a 36° swept-back wing, automatic slats, jet engine of 18 kN thrust.
NA-151	F-86A-1 Sabre (P-86A-1-NA, name assigned in March 1949)	J47-GE-7	1948	1949	With Mk 18 gunsight, jet engine of 2,360 kgf (23,1 kN) thrust, 2 speed brakes instead of 3, 6 12,7 mm Browning M3 guns (267 bullets each). Serial production at North American Inglewood (California), 33
NA-152	F-86A-5-NA (F-86B)	J47-GE-7 or J79-GE-13		1949	With enlarged fuselage and reinforced landing gear. 188 airframes built (48-129/316).

Original designation	Military designation	Engine type	Start of flight tests	Year of entering service	Note
NA-161	F-86A-5-NA	J47-GE-7 or J79-GE-13		1949	With a new armored windscreen, underwing stations for bombs and fuel tanks, weapon bay heater, without empty case automatic ejection doors. In production till December 1950, 333 airframes built (49-1007/1339).
NA-167	F-86J	Avro Orenda	1954	-	Prototype, with a Canadian jet engine, 1 airframe built (converted from F-86A-5-NA № 49-1069).
	F-86A-6	J79-GE-13			With AN/APG-5C radar rangefinder.
	F-86A-7	J79-GE-13			With AN/APG-30 radar rangefinder.
	RF-86A	J79-GE-13			Photo-reconnaissance aircraft (without weapons or with 2 lower machine guns, 2 K-24 photo-reconnaissance cameras). 11 F-86A converted.
Honeybucket, Ashtray	F-86C (YF-93A)	Pratt & Whitney J48-P-1 or J48-P-6	1950	-	Long-range escort fighter. Prototype, 2 airframes (48-317/318), North American Inglewood (California). With enlarged fuselage, side-mounted intakes, SCR-720 radar, jet engine of 2,834/3,628 (J48-P-6 – 2,722/3,970) kgf thrust with afterburner, 6 20mm guns (never installed).
NA-157	F-93A	J48-P-1 or J48-P-6	-	-	Production variant. Never built (236 airframes were planned for manufacturing).

Original designation	Military designation	Engine type	Start of flight tests	Year of entering service	Note
NA-166	YF-86D-NA (F-95A)	J47-GE-17 or J47-GE-33	1949	-	Fighter-interceptor. Prototype, 2 airframes (50-577/578) built in 1949, North American Inglewood (California). With enlarged fuselage, Fire Management System Hughes E-3, Hughes AN/APG-36 radar above air intake, 2,470 mm rocket pod Mighty Mouse in the in-fuselage platform under air intake (no small arms), jet engine with afterburner giving 2,270/3,015 (J47-GE-17) or 2,515/3,470 (J47-GE-33) kgf of thrust.
NA-164	F-86D-1-NA Sabre Dog	J47-GE-17		1951	In serial production from March 1951 by North American Inglewood (California), 36 airframes (50-455/576, etc.). In 1949-1954, North American Inglewood (California) built a total of 2,448 (other sources report 2,504) F-86D of different variants (including prototypes).
NA-165	F-86D-5-NA	J47-GE-17			26 airframes built (50-492/517).
	F-86D-10-NA	J47-GE-17			36 airframes built (50-518/553).
	F-86D-15-NA	J47-GE-17			54 airframes built (50-554/576, 50-704/734).
	F-86D-20-NA	J47-GE-17			188 airframes built (51-2944/3131). Later all converted to F-86L.
NA-177	F-86D-25-NA	J47-GE-17			88 airframes built (51-5857/5944).
	F-86D-30-NA	J47-GE-17			200 airframes built (51-5945/6144).
NA-173	F-86D-35-NA	J47-GE-17			349 airframes built (51-6145/6262, 51-8274/8505).
	F-86D-40-NA	J47-GE-17			299 airframes built.
	F-86D-45-NA	J47-GE-17			299 airframes built.
NA-190	F-86D-50-NA	J47-GE-17			299 airframes built.
	F-86D-55-NA	J47-GE-17			225 airframes built (53-0557/0781).

Original designation	Military designation	Engine type	Start of flight tests	Year of entering service	Note
NA-201	F-86D-60-NA	J47-GE-17A/B			399 airframes built (53-0782/1071, 53-3675/3710 – later all converted to F-86L, 53-4018/4090 – later all converted to F-86L).
	F-86E-1-NA	J79-GE-13 or J79-GE-15	1950	1951	Activities started in 1949. With all-flying tail, 6 M3 machine guns (300 bullets each). In serial production at North American Inglewood (California), 60 airframes (50-579/638). A total of 456 F-86E of different variants were manufactured (other sources report 336 from December 1952 to April 1952).
NA-170	F-86E-5-NA	J79-GE-13/15			51 airframes built (50-639/689).
NA-170	F-86E-10-NA	J79-GE-13/15			132 airframes built (51-2718/2849).
NA-172	F-86E-15-NA	J79-GE-13/15			With two external fuel tanks 760 liters each. 93 airframes built (51-12977/13069).
NA-172	CL-13 Sabre Mk 1	Avro Orenda	1953		Under license, based on F-86A-5 (Canadair Ltd). One airframe built ((RCAF) 19101).
	CL-13 Sabre Mk 2 (F-86E-6-CAN)	Avro Orenda			F-86E-1 under license (Canada). 350 airframes built ((RCAF) 19201/19452), of which 60 provided to the USA Air Forces in 1951 (F-86E-6-CAN).
	CL-13 Sabre Mk 3	Avro Orenda			With a jet engine of 2,724 kgf thrust. One airframe built.
	CL-13 Sabre Mk 4 (F-86E-6)	Avro Orenda			F-86E-10 under license (Canada). 438 airframes built ((RCAF) 19453/19890: of which 428 delivered to Britain (Sabre F.4), 60 to the USA, 52-10117/10236).
	F-86E	J47-GE-27	-	-	With a more powerful jet engine with afterburner. Never built (184 airframes planned to be manufactured).
NA-178	F-86E(M)	J47-GE-13/5	1956		F-86 and Sabre Mk2 upgraded for sales to NATO countries. 302 airframes converted.

Original designation	Military designation	Engine type	Start of flight tests	Year of entering service	Note
	F-86F-1-NA	J47-GE-27	1952		With 4 underwing attachments for external stores, jet engine of 2,680 kgf (26.3 kN) thrust. In serial production at North American Inglewood (California), 78 aircraft (51-2850/2927). A total of 2,239 F-86F in different variants (other sources report 2,227) built, of which 1,539 by North American Inglewood (California), 700 by North American Columbus (Ohio).
NA-172	F-86F-2	J47-GE-27			With 20 mm T-160 guns. Converted from 6 F-86F-1 (51-2855, 2861, 2867, 2868, 2884, 2900) and 4 F-86F-10 (51-2803, 2819, 2826, 2836).
NA-172 (Gunval)	F-86F-3	J47-GE-27			With 4 22 mm Oerlicon guns. Two F-86F-1 (51-2916, 2926) converted.
NA-172 (Gunval)	F-86F-5-NA	J47-GE-27			16 airframes built (51-2928/2943).
NA-172	F-86F-10-NA	J47-GE-27			With new A-4 gunsight. 34 airframes built (51-12936/12969).
NA-172	F-86F-15-NA	J47-GE-27			6 airframes built (51-12970/12976).
NA-172	F-86F-20-NH	J47-GE-27			100 airframes built (51-13070/13169).
NA-176	F-86F-25-NH	J47-GE-27			With new "6-3" wing (with increased wing chord – 6 inches at root and 3 inches at wingtip, no slats). 341 aircraft built (other sources report 598) (51-13170/13510).
NA-176	F-86F-30-NA	J47-GE-27			With new "6-3" wing. 858 airframes built.
NA-191	F-86F-35-NA	J47-GE-27			Equipped with LABS (Low Altitude Bombing System), Mk7 or Mk12 nuclear bomb. 263 airframes manufactured (53-1072/1335).
NA-191, NA-202	F-86F-26	J47-GE-27			Upgraded.

Original designation	Military designation	Engine type	Start of flight tests	Year of entering service	Note
NA-193	F-86F-40-NA	J79-GE-27			With a 30.5 cm longer wing and slats. 280 airframes built (55-3816/4030, 55-4983/5047).
NA-227	F-86F-40-NA	J79-GE-27			70 airframes built.
NA-231	F-86F-40-NA	J79-GE-27			110 airframes built.
NA-238	F-86F-40-NA	J79-GE-27			120 airframes built.
NA-256	F-86F-40-NA	J79-GE-27			For export (Japan). 300 airframes built (other sources report 340) (110 - 56-2773/2882, 110 - 56-2773/2882, 120 - 57-6338/6457: assembled at Mitsubishi).
	RF-86F	J79-GE-27	1953		Photo-reconnaissance aircraft. 35 F-86F-30 converted: 18 for USAAF, 10 for Korea, 7 for Taiwan.
Haymaker	CL-13A Sabre Mk 5	Avro Orenda 10	1953		Under license (Canada). With a jet engine with afterburner, of 2,885 kgf (28.3 kN) thrust. In serial production from 1953. 370 airframes built ((RCAF) 23001/23370, of which 75 delivered to Germany).
	CL-13B Sabre Mk 6	Avro Orenda 14	1954		F-86F-10 manufactured under license (Canada). With a jet engine with afterburner, of 3,300 kgf (32.7 kN) thrust. 655 airframes built, of which 390 for RCAF, 255 for Germany, 6 for Columbia, 34 for South African Republic.
	CA-26 Avon Sabre	Avon 20	1953		Under license, based on F-86F (Commonwealth Aircraft Corp., Australia). One airframe built (1428, (RAAF) A94-101).
	CA-27 Avon Sabre Mk 30	Avon 20	1954		22 airframes built (CA27-1/22, (RAAF) A94-901/A-94-922). A total of 111 CA-27 airframes built.
	CA-27 Avon Sabre Mk 31	Avon 20			20 airframes built (CA27-23/42, (RAAF)).
	CA-27 Avon Sabre Mk 32	Avon 26			69 airframes built (CA27-91/111, (RAAF) A94-351/A94-371).

Original designation	Military designation	Engine type	Start of flight tests	Year of entering service	Note
	TF-86F	J79-GE-27	1954	-	Two-seat trainer. Two prototypes built (converted from F-86F 52-5616 and 53-1228). Fuselage lengthened by 1,6 m, wing moved by 20 cm. Two 12,7 mm machine guns. Program stopped in 1955 in favor of F-100F.
NA-204, NA-216	F-86G	J47-GE-17B			With an uprated jet engine. 406 F-86D airframes built.
	YF-86H-1-NA	J79-GE-3	1953	-	Multipurpose fighter. Two prototypes built (52-1975/1976) by North American Inglewood (California). With a jet engine of 4,045 kgf (39,7 kN) thrust, "6-3" wing, larger fin, smaller rudder, elongated and forward-moved nose landing gear, F-86D canopy, 6 12,7 mm machine guns, internal fuel tank capacity reduced to 2,127 liters.
NA-187	F-86H-1-NA	J79-GE-3	1953	1954	In serial production at North American Columbus (Ohio), 112 airframes built (52-1977/2088). From January 1954 to April 1956, 473 airframes manufactured by North American Columbus (Ohio).
	YF-86H-5-NA	J79-GE-3			With 4 20 mm M39 cannons (200 projectiles each). 36 airframes built (52-2089/2124).
	F-86H-5-NH	J79-GE-3			25 airframes built (52-5729/5723).
	F-86H-10-NH	J79-GE-3			With 4 20 mm M39 cannons (200 projectiles each). Combat load: 900 kg. 300 airframes built (53-1229/1528).

Original designation	Military designation	Engine type	Start of flight tests	Year of entering service	Note
NA-203	YF-86K	J47-GE-17B	1954	-	Fighter-interceptor with a stretched fuselage, North American MG-4 Fire Control System, AN/APG-36 radar, 4 20 mm Pontiac M-24A1 cannons (132 projectiles each), jet engine with afterburner of 2,461/3,620 kgf thrust, slatted wing. Two prototypes built (52-3630, 52-3804) by North American Inglewood (California).
NA-207	F-86K	J47-GE-17B			Export version (for Italy). 50 airframes built (53-8273/8322, assembled by Fiat).
NA-222	F-86K-13-NA	J47-GE-17B			Export version (for Norway). 2 airframes built (54-1231/1232), North American Fresno (California).
NA-213	F-86K-14-NA	J47-GE-17B			Export version (for Norway, Netherlands). 6 airframes built (54-1233/1234 - Norway, 54-1235/1238 - Netherlands), North American Fresno (California).
	F-86K-15-NA	J47-GE-17B			Export version (for Netherlands, Norway). 12 airframes built (54-1239/1250: 54-1239, 1241/1244, 1246, 1249, 1250 - Netherlands, 54-1240, 1242, 1243, 1245, 1247, 1248 - Norway), North American Fresno (California).
	F-86K-17-NA	J47-GE-17B			Export version (for Norway and Netherlands). 25 airframes built (54-1251/1275: 12 for Norway, 13 for Netherlands), North American Fresno (California).
	F-86K-18-NA	J47-GE-17B			Export version (for Netherlands and Norway). 25 airframes built (54-1276/1300: 12 for Netherlands, 13 for Norway), North American Fresno (California).
	F-86K	J47-GE-17B			Export version (for Italy, France, Germany, Norway, Netherlands). 126 airframes built (55-4811/4936: assembled by Fiat).

Original designation	Military designation	Engine type	Start of flight tests	Year of entering service	Note
NA-221	F-86K	J47-GE-17B			Export version (for Germany). 45 airframes built (56-4116/4160: assembled by Fiat).
NA-242	F-86L Sabrejet	J47-GE-33		1956	Fighter-interceptor. Converted from F-86D in 1956-1958. 981 airframes built (other sources report 827). With upgraded avionics, elongated wing, jet engine with afterburner of 2,517/3,470 kgf thrust.
Follow on	DF-86A	J47-GE-7 or J79-GE-13			Drone director (converted from F-86A).
	QF-86E	1xAvro Orenda 10			Target drone (converted from Sabre Mk. 5 airframes for U.S. Army), 1975-1996.
	QF-86F	J79-GE-27			Target drone (approx. 50 airframes converted from F-86F, for U.S. Navy), 1981.
	QF-86H	J79-GE-3			Target drone (29 airframes, other sources report 31, converted from F-86H, U.S. Naval Weapon Center), 1972.

F-86 Sabrejets of all modifications were exported to over 30 countries. See Table 1.2.

Table 1.2

Country	Number of exported aircraft
Great Britain	3 CL-13 Mk 2, 428 CL-13 Mk 4 (Sabre F.4) in 1952-53
Turkey	102 CL-13 Mk 2 in 1954-58, 12 F-86F in 1958, 50 F-86D, 40 F-86K
Taiwan	~160 F-86F-1-NA/F-30-NA in 1954-56, 320 F-86F in 1958, 7 RF-86F in 1958, 18 F-86D
Greece	100-110 CL-13 Mk 2 in 1954, 50 F-86D in 1958
Republic of South Africa	22 F-86F-40 in 1950s, 34 CL-13 Sabre Mk 6 in 1954-56
Belgium	5 F-86F in 1955
Netherlands	63 F-86K (6 of which assembled in Italy) in 1955-56
Norway	64 F-86K in 1955-56, 115 F-86F in 1957-58
Spain	270 F-86F-20/25/30 in 1955-58 (in the course of operation upgraded to F-86F-40)
Italy	63 (other sources report 120) F-86K, 179 Sabre F.4 – F-86E(M) from UK
Belgium	5 F-86F-25 in 1955
Japan	180 F-86F in 1955-57, 122 F-86D-25/30/35 in 1958-62

Country	Number of exported aircraft
Korea	102 F-86F in 1955-58, 10 RF-86F in 1958, 40 F-86D
Peru	26 F-86F-25 in 1955
Venezuela	30 F-86F and 74 F-86K in 1955-60 (assembled in Italy), 51 F-86K from Germany
France	62 F-86K in 1956-57 (assembled in Italy)
Pakistan	102 F-86F-35/40 in 1956-58 (other sources report export started in 1954), 90 CL-13 Sabre Mk 6 in 1966 (from Germany via Iran)
Columbia	6 SL-13B Mk 6 in 1956, 2 F-86F from Spain and 1 F-86F from US
Germany	75 CL-13A Sabre Mk 5 in 1957, 255 CL-13B Sabre Mk 6 in 1959, 88 F-86K in 1957-58 assembled in Italy
Philippines	40 F-86F-25/30/35 from Royal Thai Air Force in 1957-58, 20 F-86D in 1958
Denmark	58 F-86D in 1958-60
Portugal	50 F-86F in 1958, 15 CL-13B Mk 6 from Germany, several airframes from Norway in 1968-69
Saudi Arabia	16 F-86F in 1958, 3 from Norway in 1966
Iraq	5 F-86F in 1958 (later delivered to Pakistan)
Iran	F-86F
Ethiopia	14 (other sources report 25) F-86F in 1960
Yugoslavia	130 F-86D in 1961; 121 Sabre F.4 – F-86E(M) from UK
Argentina	28 F-86F in 1961
Thailand	40 F-86F in 1961-62, F-86L
Tunisia	15 F-86F in 1969
Honduras	8 CL-13 Mk 2 from Yugoslavia, 14 F-86F, 5 F-86K from Venezuela in 1969
Malaysia	18 CA-27 in 1969
Bangladesh	5 SL-13 Sabre Mk 6 from Korea in 1971
Burma (Myanmar)	12 CL-13 Mk 6 from Pakistan in 1970s
Bolivia	10 F-86A from Venezuela in 1973
Indonesia	18 CA-27 in 1973, 5 CA-27 from Malaysia in 1975

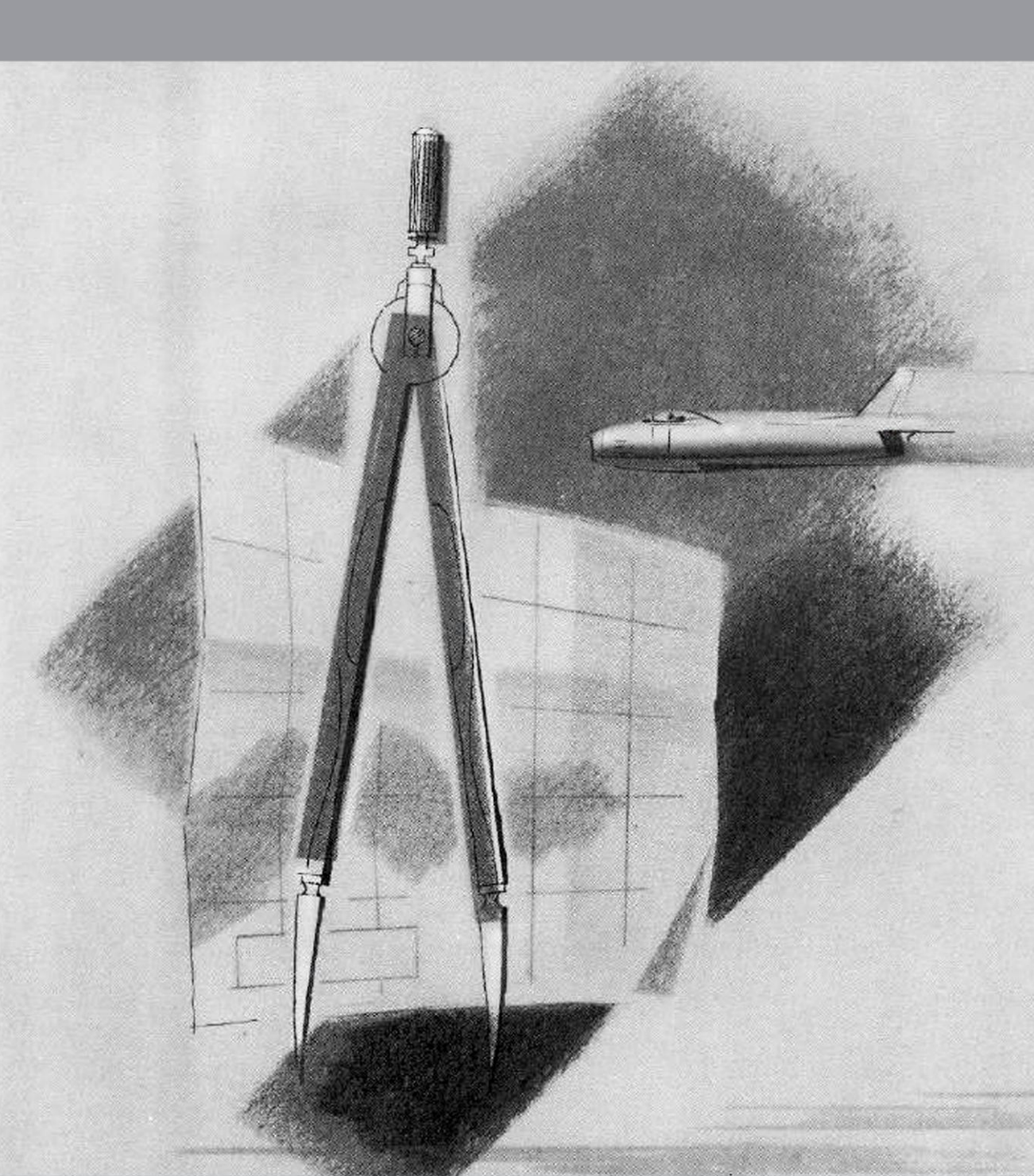

2

MISSION OVERVIEW AND MAIN SPECIFICATIONS

2. MISSION OVERVIEW AND MAIN SPECIFICATIONS

2.1. Mission overview

The aircraft's main purpose is to gain daytime air superiority. It can also be used as an attack aircraft.

2.2. Main specifications

The F-86F Sabre is an all-metal, single-seat, high-performance day-fighter powered by an axial-flow turbojet engine. This version of the Sabre has the familiar swept-back wing and empennage configuration typical of all F-86 series airplanes. The airplane is equipped with a conventional, fully retractable, tricycle landing gear, and has slotted-type flaps and fuselage-mounted speed brakes. To maintain desirable handling characteristics throughout the speed range of the airplane, the ailerons and horizontal tail are actuated by an irreversible hydraulic control system. The use of irreversible controls necessitates the inclusion of an artificial-feel system to simulate desired aerodynamic feel, and has the advantage of providing comfortable stick forces. In addition, the elevator and stabilizer are interconnected and controlled as one unit, with the result that the entire horizontal tail assembly serves as an effective primary control surface.

2.2.1. Specifications table

Table 2.1

CHARACTERISTICS	Unit	Value
A. NORMAL CREW	per aircraft	1
B. OPERATIONAL CHARACTERISTICS		
(1) Max allowable takeoff weight	lbs / kg	20.611 / 9.348
(2) Empty weight	lbs / kg	11.125 / 5.046
(3) Useful load (with 230 lbs pilot)	lbs / kg	6.607 / 2.996
(4) Weight with payload for normal mission	lbs / kg	15.175 / 6.883
(5) Usable internal fuel capacity (JP-4, fuel density 0.778 kg/l)	lbs/gal // kg/l	2.826/435 // 1.282/1.647
(6) Fuel consumption rate (for loiter at 30.000 ft, 192 knots CAS, 74% RPM, 12.296-15.138 lbs gross weight)	lbs/h // kg/h	~1.150 / 522
(7) Normal cruise speed (for max range at 35.000 ft, 78% RPM, 12.296- 15.138 lbs gross weight)	knots / km/h	260 / 482
(8) Maximum speed at sea level	knots / km/h	600 / 1.111
(9) Maximum speed at 33.000 ft	knots / km/h	313 / 580
(10) Service ceiling (for 14.000 lbs takeoff weight)	ft / m	52.000 / 15.850
(11) Maximum rate of climb	m/min	2835
(12) Maximum range	nm / km	1.395 / 2.584
C. DIMENSIONS		
(1) Length	ft-in / m	37'6" / 11.430
(2) Width (wingspan)	ft-in / m	39'1" / 11.913
(3) Height to fin	ft-in / m	14'9" / 4.496
(4) Height to canopy	ft-in / m	9'4" / 2.850
(5) Wing sweep	deg	35
(6) Main wheel track	ft-in / m	8'5" / 2.560
(7) Main wheel base	ft-in / m	15'1" / 4.600
D. WEAPONS		
(1) 0.5 in (12.7 mm) caliber Colt-Browning M3 machine guns	number guns x number rounds	6 x 300 (for each of them)
(2) M64A1 bombs	number x caliber (lbs)	2 x 500
(3) HVAR rockets	number x caliber (lbs)	16 x 5-inch (2.144 lbs for 16 HVARs)

2.2.2. Aircraft dimensions

See [Figure 2.1](#) for dimensions of the F-86F.

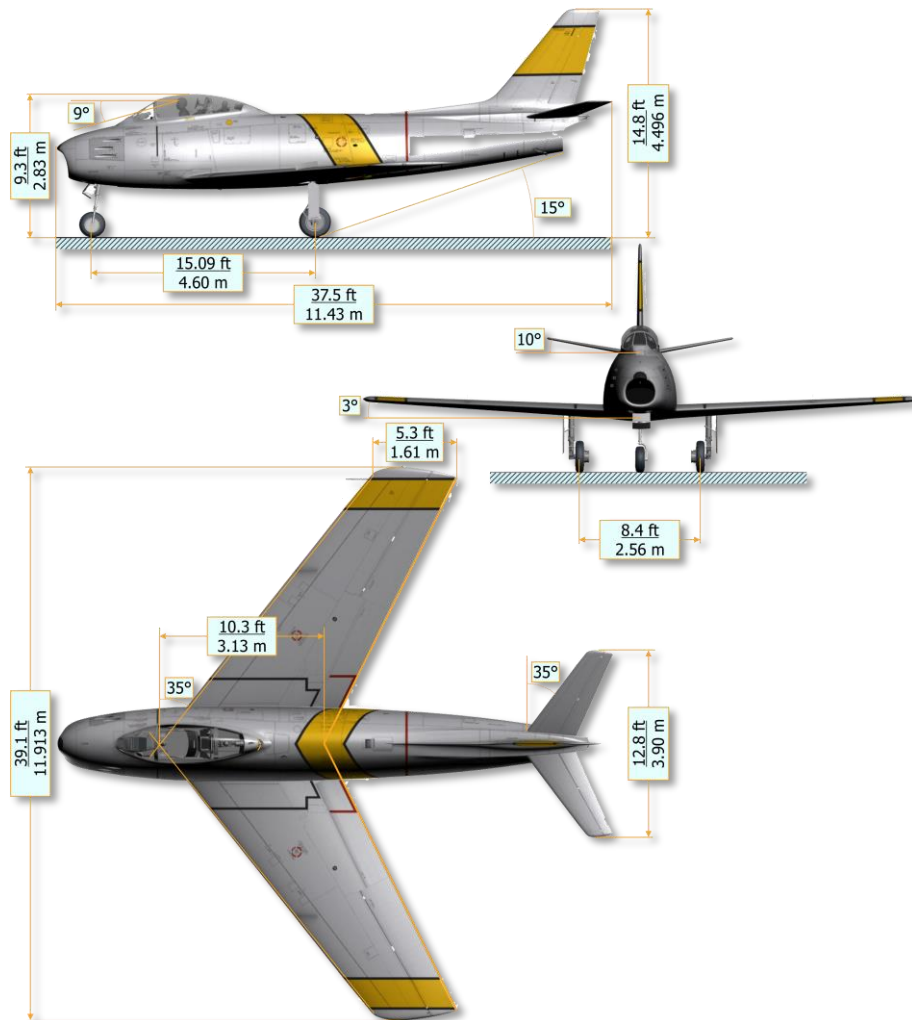
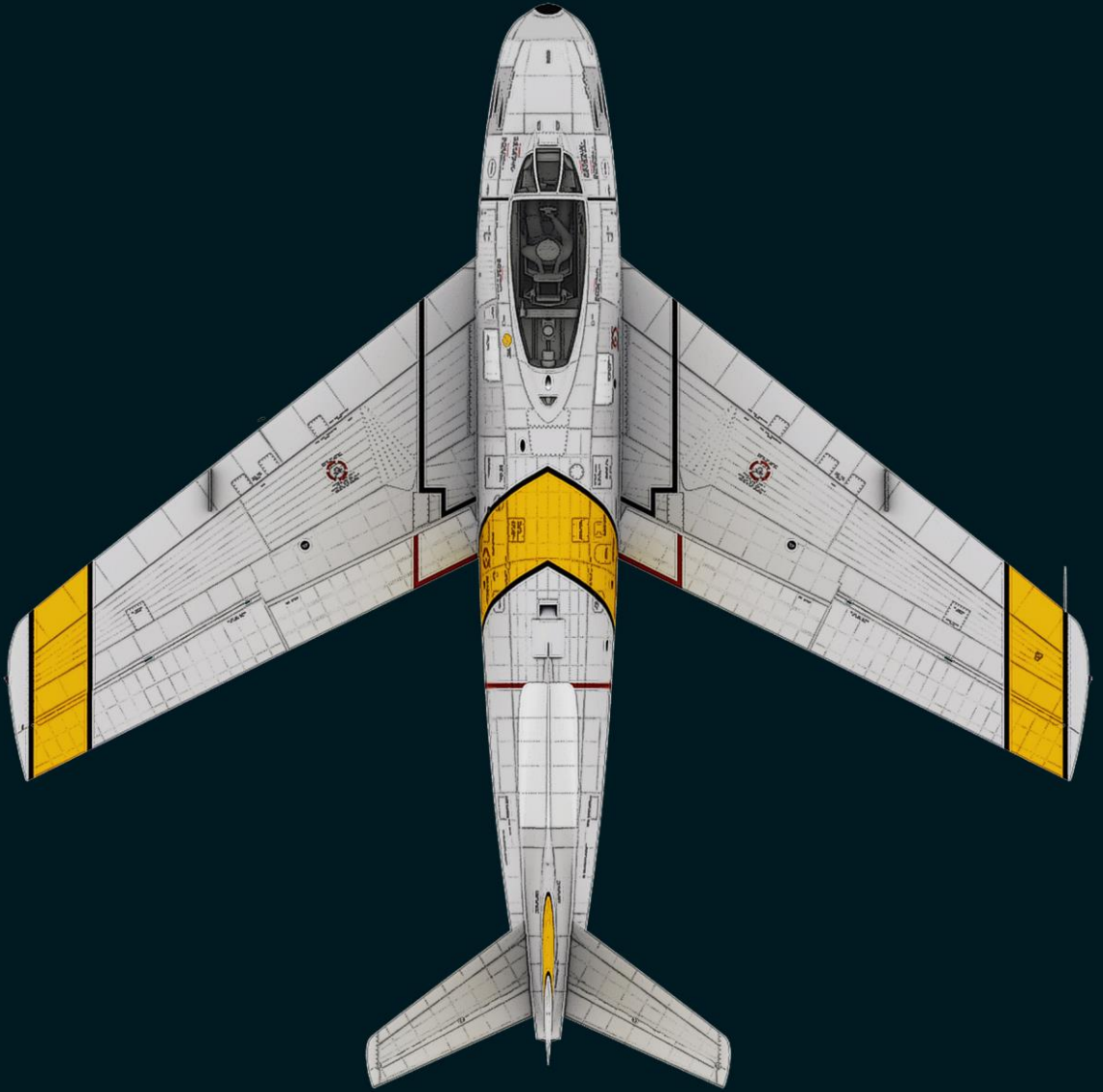

Figure 2.1. F-86F dimensions



3

**AIRCRAFT
AND ENGINE DESIGN**

3. AIRCRAFT AND ENGINE DESIGN

3.1. Aircraft Design

The F-86F was designed as a solid-metal, single-seat jet fighter with a single engine and swept wing.

3.1.1. Fuselage

The fuselage is a semi-monocoque structure, divided into forward and rear parts. The forward part hosts the air intake, the electronic equipment and armament bays, the pressurized cockpit, the radio equipment bay behind the cockpit, and the forward and aft fuel tanks. The engine is attached with trunnions of load-carrying frames in the forward fuselage. The air intake channel bends around the cockpit from the bottom.

On the upper lip of the air intake, behind the radio-transparent radome, is a radar rangefinder antenna ([Figure 3.1, 12](#)). A gun camera is installed on the lower lip of the air intake ([Figure 3.1, 13](#)).

The equipment bay in front of the cockpit is the housing for a battery, radio rangefinder units, the gunsight computer, radio station, and oxygen cylinders.

Behind the forward equipment bay, the aircraft has a pressurized cockpit covered by a teardrop-shaped canopy. To open, the rear part of the canopy slides backwards. An ejection seat ensures a safe egress from the aircraft at airspeeds above 170 km/h in a range of altitudes from 100 m to the aircraft's operating ceiling (currently simulated is a standard ejection seat, allowing ejection at a speed of 0 km/h and an altitude of 0 m).

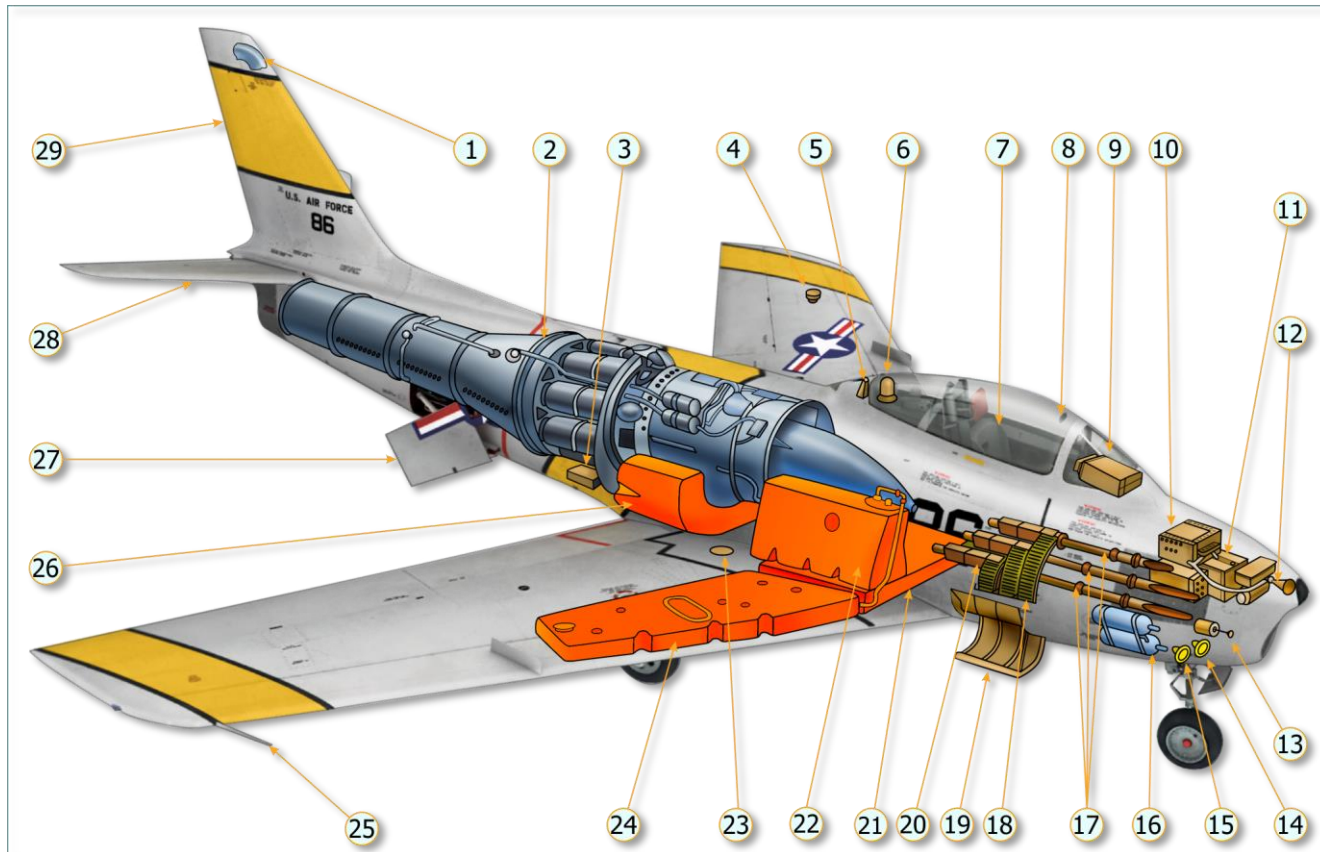

Figure 3.1. General assembly of the F-86F

1. Command radio antenna
2. J47-GE-27 engine
3. Aft radio compartment
4. Directional indicator transmitter
5. Radio compass sense antenna
6. Radio compass loop antenna
7. Ejection seat
8. Rear-vision mirror
9. Gun-bomb-rocket sight
10. Radar ranging equipment
11. Battery
12. Radar antenna
13. Gun camera
14. Retractable landing and taxi light
15. Retractable landing light
16. Oxygen cylinders
17. Gun barrels
18. Ammunition compartment
19. Ammunition compartment access door
20. Gun compartment
21. Forward fuselage tank (lower cell)
22. Forward fuselage tank (upper cell)
23. Identification radar antenna
24. Outer wing fuel tank
25. Pitot head
26. Aft fuselage fuel tank
27. Speed brake
28. Controllable horizontal tail
(elevator and controllable stabilizer)
29. Fin

Behind the pilot seat, there is a radio compass loop antenna and a radio equipment bay. Below the pilot seat are the upper and lower cells of the forward fuselage fuel tank. The overall capacity of these cells is 1,647 liters. Left and right of the cockpit, there are armament bays covered by quick-detachable panels.

The rear fuselage is made up of the vertical fin and horizontal stabilizers, the engine extension pipe, the left and right speed brakes, and the fuel system drain pipe which extends out the left side of the tail section.

3.1.2. Wing

The aircraft has a two-spar swept wing with a leading edge sweepback angle of 35°. The wing has a relative thickness of 11% at the root and 10% at the tip.

In the central wing section, in the space between spars, there is a wing fuel tank. On the outer half wing's trailing edge are the ailerons ([Figure 3.2](#)), and on the inner half wing's trailing edge are the flaps.



Figure 3.2. Ailerons

The wing allows for the installation of pylons on the lower surface that can take fuel tanks or bombs of various calibers. Additionally, on the tip of the right wing is a pitot tube.

3.1.3. Flaps

Flaps are installed on the trailing edge of each inner half-wing ([Figure 3.3](#)).

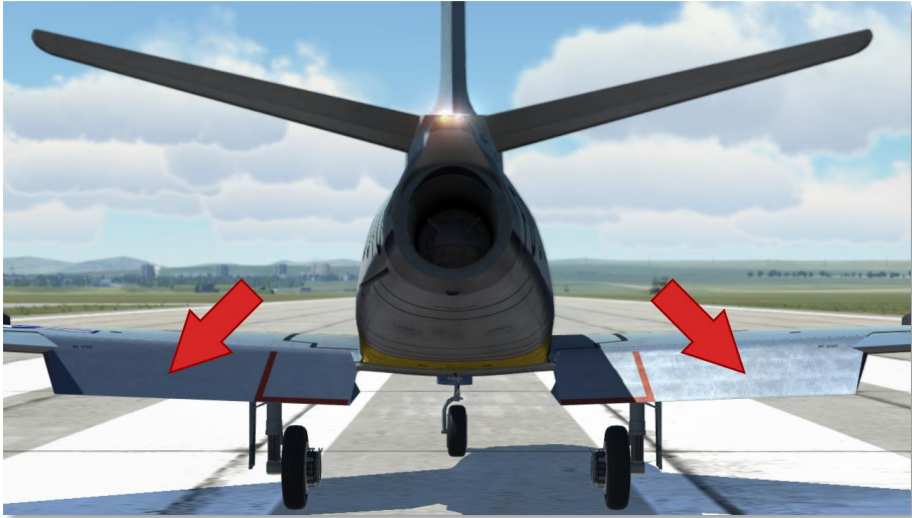
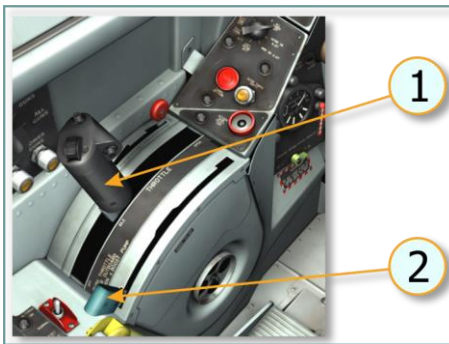

Figure 3.3. Flaps

The flaps are controlled with the wing flap lever, located in the cockpit on the left control pedestal, to the right of the engine throttle.



1. Engine throttle
2. Wing flap lever **[F]**

The flap system is controlled electrically with power supplied by the primary bus.

Each flap is actuated by an individual electrical circuit and an individual electric motor. The flaps are mechanically interconnected. This ensures availability of both flaps in case of failure of a single electrical circuit or failure of a single electric motor. It also prevents asynchronous extension and retraction of flaps.

For flap extension or retraction, the wing flap lever is put into a corresponding full position – full forward or full aft, respectively.

It is possible to extend (retract) the flaps partially by putting the lever into an intermediate position (extension [**Shift + F**], retraction [**Ctrl + F**]). By pressing and holding down the respective combination of keys, the flaps are extended or retracted. As soon as the keys are released, the flaps stop.

Note. There is no flap position indicator in the cockpit.

3.1.4. Speed brakes

Speed brakes are installed on the rear fuselage, one on each side, at a lower height than the horizontal tail ([Figure 3.4](#)).



Figure 3.4. Extended speed brakes

The speed brakes are operated by the aircraft's hydraulic system and controlled from the cockpit with the speed brake switch on the engine throttle. The switch has three fixed positions: IN (retraction) – HOLD (holding in current position) – OUT (extension).

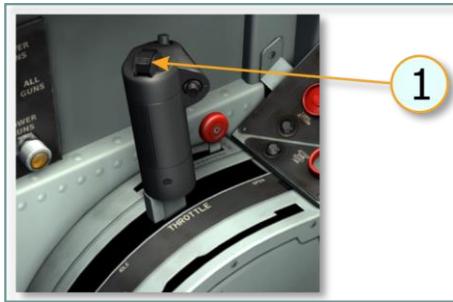

1. Speed brake switch [B]

Full extension of the speed brakes takes ~ 2 sec, while full retraction takes ~ 2.5 sec. During speed brake extension/retraction, it is possible to fix them in an intermediate position by putting the control switch into the HOLD position.

3.1.5. Empennage

The empennage is single-fin, swept back.

The *VERTICAL TAIL* consists of a fin and rudder.

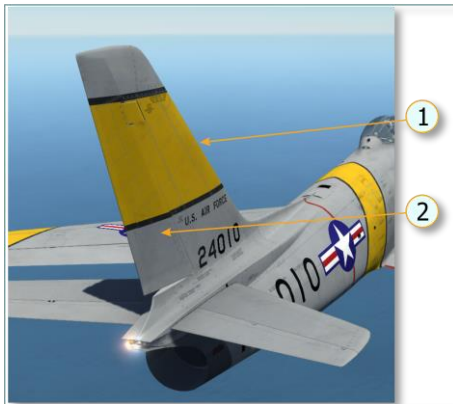

1. Fin
2. Rudder [Z], [X]

Figure 3.5. Vertical tail

The rudder, an element of the airplane's [Control System](#), contains a trim tab.

The *HORIZONTAL TAIL* consists of two stabilizers, each one containing an elevator (another element of the airplane's [Control System](#)).

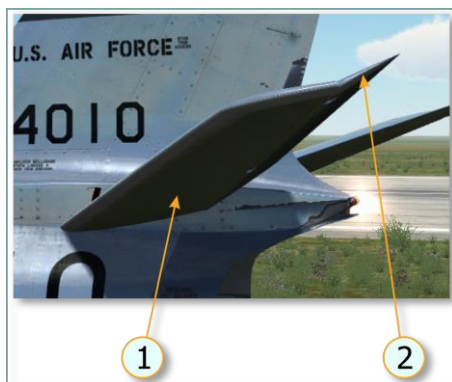

1. Stabilizer
2. Elevator [↓], [↑]

Figure 3.6. Horizontal tail

The stabilizer deflection range is $+6^\circ$ to -10° . For all control surfaces on the empennage, a rigid control is used.

3.1.6. Landing gear

The landing gear is in a tricycle configuration with the nose gear being attached to the first load-carrying frame. During taxi, the nose wheel is turned by the steering mechanism [S].



The nose gear is retracted aft into the nose landing gear bay in the lower fuselage. For retraction, the nose gear rotates 90 degrees as the gear folds so that the wheel is horizontal (in the direction of flight) when retracted. The main landing gears are attached to the wing. For retraction, the main gears are

moved into their bays in the central wing section. Retraction and extension are done with a hydraulic actuator. Emergency extension can be done from the residual pressure in the [Utility Hydraulic System](#). The wheel brakes are hydraulic, shoe-type.

3.1.7. Canopy

General description

The single-piece sliding canopy can be controlled either from the cockpit or from outside the airplane (this function is currently not implemented in the simulation). The canopy actuator is powered by the primary bus when the secondary bus is energized. If secondary bus power is not available, the actuator circuit is transferred to the battery bus so that the canopy is operable regardless of the position of the battery-starter switch. Provisions are included to permit manual operation of the canopy on the ground either from the cockpit or externally. During flight, emergency release of the canopy is accomplished by a remover that fires the canopy directly aft. The seat can be ejected through the canopy if the canopy fails to jettison.

Canopy Seal

Pressure for inflation of the seal, which seals the canopy in the closed position, is provided by air from the engine compressor section (see [5.7](#)) and is automatically controlled by a pressure regulator. The seal is inflated whenever the canopy is fully closed and the engine is operating. When the canopy switch is actuated, the seal is automatically deflated to allow the canopy to move. The seal is also automatically deflated before canopy ejection.

NOTE: If the canopy switch is moved to CLOSE during flight, the canopy seal is deflated. This action at altitude results in loss of cockpit pressurization. However, when the switch is released, the seal is inflated and the cockpit becomes pressurized again.

Canopy Controls

CANOPY SWITCH. The canopy is controlled from within the cockpit by a guarded three-position toggle switch above the left forward console, [Figure 3.7](#):



Figure 3.7. Canopy switch

To close the canopy, the switch must be held at the spring-loaded CLOSE (forward) position (**[L]Ctrl + C**) or **RClick** the switch), [Figure 3.8](#).



Figure 3.8. Closed (left) and opened (right) canopy

Moving the switch to OPEN will open the canopy. When the canopy reaches the full open position, power to the canopy actuator is automatically cut off. When the switch is at its center OFF position, the canopy is locked, whether fully open, partially open, or closed.

CANOPY EXTERNAL CONTROL BUTTONS. The canopy is operated externally by two spring-loaded pushbuttons on each side of the fuselage, approximately 2 ft below and in line with the windshield bow. One button is marked OPEN, the other one CLOSED. Depressing either button results in corresponding operation of the canopy (not simulated).

CANOPY DECLUTCH HANDLE. The canopy declutch handle, located at the bottom of the center pedestal (on the emergency control panel), is intended for emergency use on the ground only, [Figure 3.9](#).

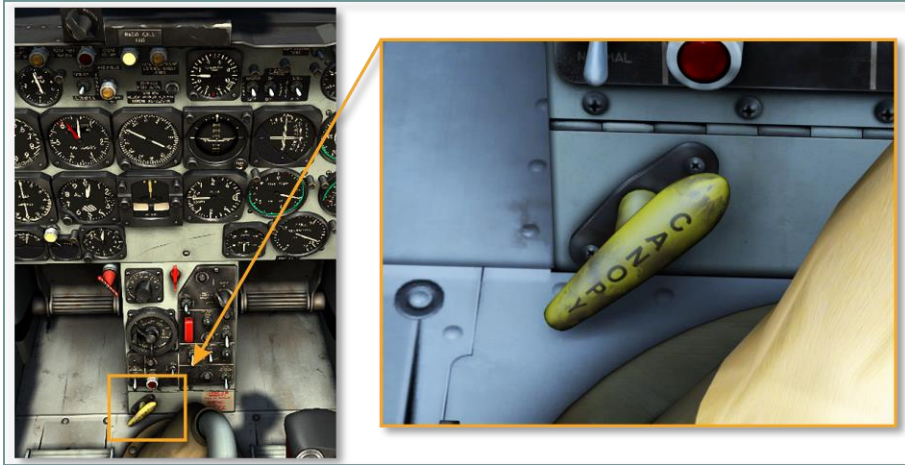

Figure 3.9. Canopy declutch handle

Pulling the declutch handle out fully (approximately 2 inches) **[RAIt + C]** mechanically disengages the canopy from the drive shaft so that the canopy can be moved manually. When the handle is released, the canopy can be re-engaged only by releasing the lock mechanism located just aft of the seat (not simulated). The canopy declutch handle does not fire the canopy remover.

When this handle is released, the canopy switch is not functional.

CANOPY MANUAL OPERATING HANDLE (not simulated). The canopy manual operating handle, located inside the canopy on the right side of the canopy bow, is used for pulling the canopy open on the ground in case it cannot be opened electrically, or in flight only if the canopy must be declutched for removal, [Figure 3.10](#).

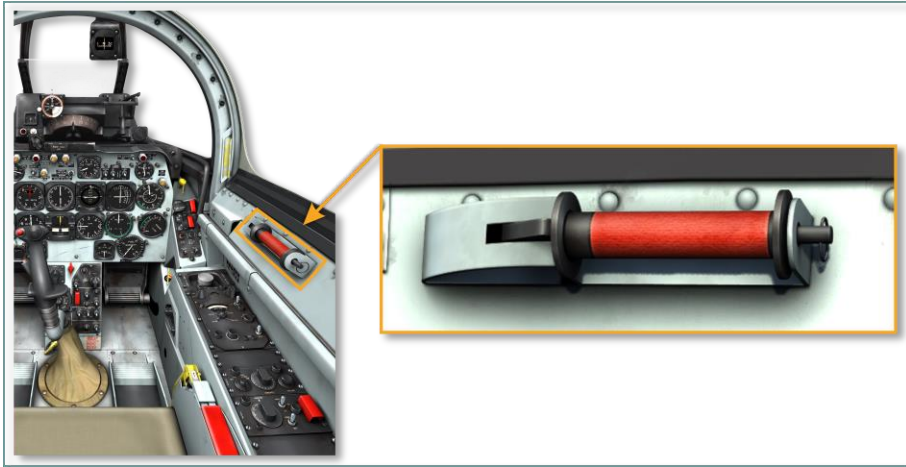

Figure 3.10. Canopy manual operating handle

CANOPY EMERGENCY JETTISON RELEASE. When either handgrip is pulled full up [**L**Ctrl + **E** + **E** + **E**] in preparation for seat ejection, the canopy remover is fired to jettison the canopy directly aft for emergency ejection (the canopy can be jettisoned at any airspeed or airplane attitude). Raising either handgrip fires a cartridge in the canopy initiator. The gases produced move a piston in the exactor. Movement of the exactor piston pulls the sear pin from the canopy remover, causing the remover to fire.

CANOPY ALTERNATE EMERGENCY JETTISON HANDLE. A canopy alternate emergency jettison handle [**L**Ctrl + **L**Shift + **C**] permits the canopy to be jettisoned without arming the seat catapult (for example, after an emergency landing), [Figure 3.11](#).



Figure 3.11. Canopy alternate emergency jettison handle

The handle labeled "ALT CANOPY JET" is just to the right of the instrument panel. When this handle is pulled to its full extended position (approximately 2 inches), a mechanical linkage withdraws the canopy initiator sear pin, firing a cartridge within the initiator. This actuates the exactor and fires the canopy remover.

Note. This handle is provided as an alternate means of removing the canopy and is designed to be used when it is desired to jettison the canopy without arming the seat catapult. It should not be used in place of the seat handgrip sequence when ejection from the airplane is intended.

3.2. Engine and related systems

3.2.1. General design and layout

The aircraft's power plant includes a General Electric J47-GE-27 jet engine with a static thrust of 2,680 kgf (6,000 lb) and the following supporting systems: fuel automation system, fuel system, oil system, and fire protection system.

In the front, the aircraft has an air intake. The air is sucked into it, goes through the air channel under the cockpit and reaches the engine. From there, the air is directed to the axial-flow compressor where it is compressed in 12 stages. Compressed air, mixed with fuel spray, goes to the eight-section combustion chamber.

While the engine is started and running, this mixture is continuously burning. From the combustion chamber, hot gases pass through a single-stage turbine into the exhaust nozzle which is an expanding pipe. In the exhaust pipe, hot gases are accelerated and form a jet stream (jet thrust).

The turbine is rotated by the energy of the hot gases passing through it and mechanically transmits rotation to the compressor and engine system components. The cockpit and fuel tanks are separated from the engine compartment by a special protective wall. The engine compartment itself is divided by a fire-resistant wall. The forward part is relatively cool and includes a compressor and engine system components. The rear part hosts the combustion chamber, turbine, and exhaust nozzle.

The engine performance characteristics are given in Table 3.1.

Table 3.1

J47-GE-27 engine characteristics	
Maximum thrust, kilopond-pound-force, kiloNewton, kilogram-force	5,970 lbf, 26.56 kN, 2,708 kp at 7,950 RPM
Compressor	12-stage axial compressor
Turbine	Single-stage axial
Specific fuel consumption lb/lbf/hr	1.014
Airflow rate, lb/s kg/s	92 / 42
Overall pressure Compression ratio, times	5.35
Tc max, K	1,170
Length, inch / mm	145 / 3,700
Diameter, inch / mm	36.75 / 933
Dry weight, lbs / kg	2,554 / 1,158
Service life, h	200

3.2.2. Engine scheme

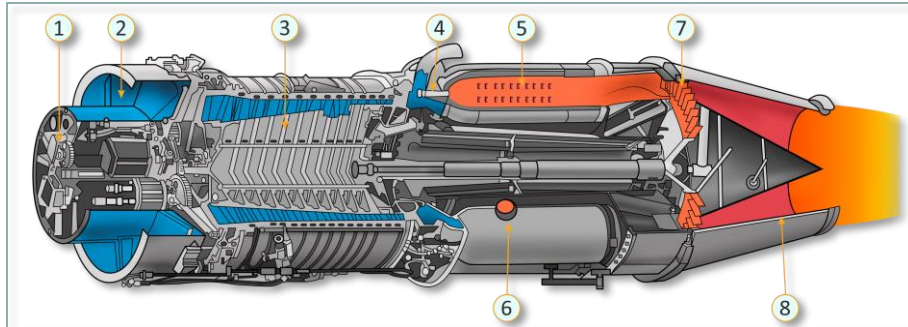

Figure 3.12. J47-GE-27 engine scheme

- | | |
|---------------------|-----------------------|
| 1. Gearbox | 5. Combustion chamber |
| 2. Air flow channel | 6. Ignition system |
| 3. Compressor | 7. Turbine |
| 4. Fuel nozzle | 8. Exhaust nozzle |

3.2.3. Engine fuel automation system

The engine fuel flow rate is controlled by the fuel control system (fuel automation system) that consists of the main fuel system and emergency fuel system. The emergency system maintains the required fuel flow rate if the main system fails. The general scheme is shown in [Figure 3.13](#).

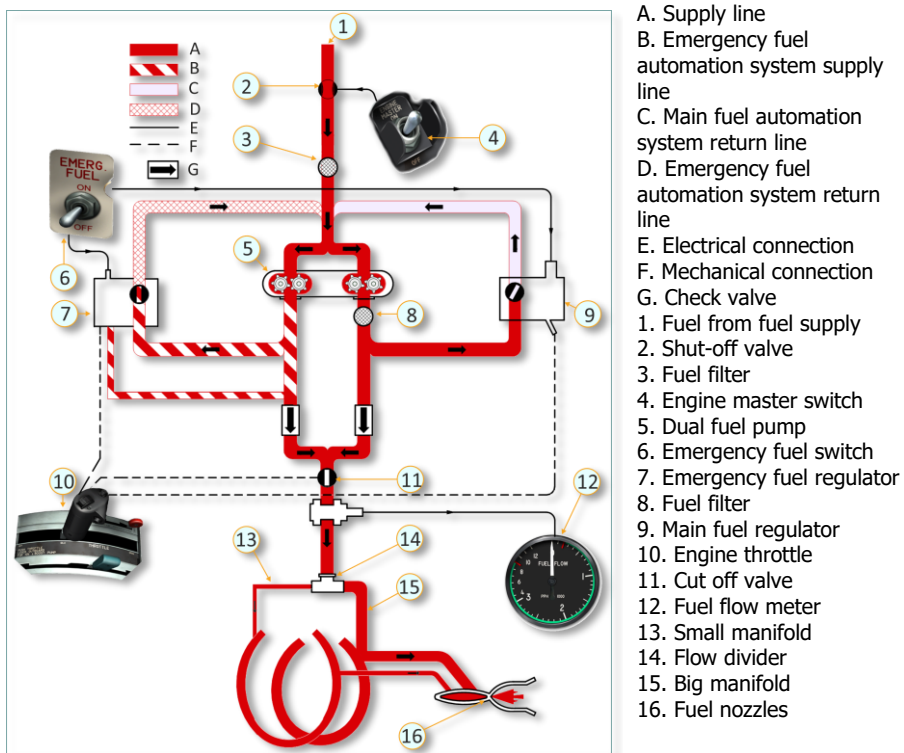

Figure 3.13. Engine fuel automation system

3.2.4. Main fuel automation system

The purpose of the main fuel automation system is to ensure stable performance of the engine on the ground during taxi and in flight (Figure 3.13). The main elements of the fuel automation system are the fuel pump, the digital fuel regulator, and the fuel control valve. The fuel pump is powered by mechanical energy transmitted from the engine gearbox (engine rotor).

The efficiency of the fuel pump depends only on the engine RPM. The amount of fuel coming into the engine is controlled by the fuel regulator which is mechanically connected with the engine throttle. It controls the inflow of fuel to the engine depending on the position of the engine throttle that corresponds to certain engine RPM. The fuel regulator also maintains the engine RPM determined by throttle input in case of a change in flight conditions (altitude

and airspeed). The fuel does not go through the regulator itself. A change of the fuel flow rate is executed by the fuel control valve that is actuated by the fuel regulator.

The fuel control valve directs some of the fuel to the engine and returns some of the fuel back to the fuel pump through the return line. The fuel automation system controls engine RPM in a range of 30% to 100%.

Idle RPM ensure a continuous stable burning in the combustion chamber at the lowest possible RPM. With an increase of altitude, the content of oxygen in the air decreases, so the engine needs more air for stable performance. The engine automation system increases the idle RPM with an increase of altitude ([Figure 3.14](#)).

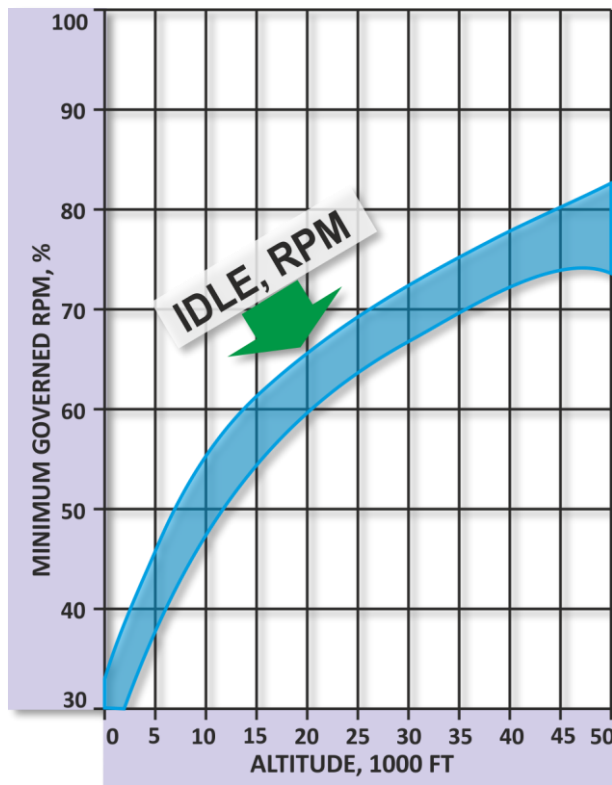

Figure 3.14. Idle RPM vs flight altitude

Caution. When flying at an altitude below 3,000 m (10,000 ft) at an outside air temperature lower than 10°C (50°F) at RPM below 70% with the engine operated by the main fuel automation system, an abrupt forward movement of the engine throttle may result in a failure of the compressor and complete engine shutdown.

3.2.5. Emergency fuel automation system

The emergency fuel automation system ([Figure 3.13](#)) consists of a fuel pump and an emergency fuel regulator with the engine fuel supply control valve. During normal operation of the main fuel automation system, the emergency fuel automation system is off and the fuel supply control valve is closed. If the main fuel automation system fails and the EMERG FUEL switch is switched on, the emergency fuel system valve receives a signal for opening, the main fuel automation system valve is closed, and the main system is completely cut off.

Main fuel automation system failure is seen as a broken connection between the position of the throttle handle and engine RPM, i.e. if movement of the throttle handle does not change (increase or decrease) engine RPM, then there is a failure in the main fuel automation system.

The emergency fuel regulator maintains the target RPM in case of a change in altitude, but does not take into account changes of airspeed.

Note. The emergency fuel regulator maintains the engine RPM in a range of 30% - 99% at a temperature of ~38°C (100°F). In case of temperature decrease, the upper RPM limit decreases too.

Fuel pressure controller

It is located immediately in front of the engine supplying element and consists of a big manifold and a small manifold. The controller automatically regulates fuel pressure to ensure stable performance of the engine. At engine start and at low fuel consumption, a small manifold is used. With the increase of fuel pressure above 50 PSI, both manifolds are engaged.

3.2.6. Engine oil system

Retention of oil pressure in the oil system and the supply of oil to parts in rubbing contact are fully automated and do not require manual control. In the lower right part of the fuselage, there is a 13.5 liter (3.5 gallon) oil tank. From the oil tank, oil is supplied to the oil pump, and from there to all engine parts that require lubrication. Oil is also supplied to the main fuel controller. Used oil goes through the separator which separates metal chips and air from the oil.

To prevent oil overheat, the system has an oil cooler that turns on if the oil temperature becomes too high. For the monitoring of oil pressure, there is an



oil pressure indicator on the instrument panel in the cockpit indicating engine oil pressure in pounds per square inch (PSI). The gauge and the indicator are supplied by three-phase AC power.

3.2.7. Engine controls

The cockpit has the following engine controls: the fuel cut-off valve, the engine master switch (main switch of the fuel automation system), the engine throttle, and the engine monitoring instruments (tachometer indicator and EGT indicator).

Fuel cut-off valve

The fuel cut-off valve is installed in the fuel supply system downstream of the main and emergency fuel automation systems. When the engine throttle is forward of the OFF position, the valve opens to the respective extent and doses the fuel. As the engine throttle continues to move forward and reaches IDLE position, the fuel valve becomes fully open and the fuel automation system controls the fuel supply to the engine. Hence, to completely cut off fuel supply to the engine, the throttle must be moved all the way back **[End]**.

Engine master switch



Location of engine master switch (main switch of fuel automation system) on the right forward panel

The engine master switch is a two-position switch. In the ON position, it supplies electrical power for opening of the fuel supply system's shut-off valve and supplies the engine ignition and starting system. As long as the throttle is

OFF, the fuel shut-off valve is closed (regardless of the position of the switch), and fuel pumps are disengaged.

Engine throttle

The power developed by the engine depends on the RPM determined by the position of the engine throttle. For the description of the engine throttle as a cockpit element, see [4.1.2](#).



The engine throttle is mechanically connected to the fuel shut-off valve and to the main and emergency fuel controllers ([3.2.3](#)). When the main switch is turned on, the power is supplied to the engine starting system and to the fuel shut-off valve. Then, as the throttle moves from OFF to IDLE, the fuel shut-off valve opens. Fuel is supplied to the engine starting system and to the engine itself (the ignition system automatically switches off as the RPM reach approx. 23%). When the engine is on, the throttle position determines the target RPM.

The following controls are located on the throttle: microphone button, rotating grip for sight manual ranging, speed brake switch, sight electrical caging button ([Figure 4.4](#)).

Engine monitoring instruments

TACHOMETER. The tachometer ([4.2.17](#)) is located on the instrument panel and indicates the engine RPM expressed in percentage of the maximum nominal turbine rotation speed (100% corresponds to 7950 RPM). Assessment of engine RPM together with EGT temperature allows you to not exceed engine limitations. The tachometer receives power supply from its generator located on the engine rotor shaft and does not depend on the aircraft electrical system.



EGT INDICATOR. The EGT indicator ([4.2.18](#)) is located on the instrument panel and shows the temperature of exhaust gases coming out of the engine expressed in degrees Celsius. The readings are taken from thermocouple sensors installed on the engine hot gas line behind the turbine. The indicator is an autonomous unit and does not require any external power.





4

COCKPIT

4. COCKPIT

The cockpit ([Figure 4.1](#)) accommodates the aircraft and engine controls, the instrument panel, the armament control panel, the gunsight, the left panel (with instruments and equipment), and the right panel (with instruments and equipment).

In this manual, all cockpit objects are described in groups: airplane and engine controls, instrument panel, left-side equipment, right-side equipment, and separately installed cockpit objects. If an object (panel) includes elements of one system only, then it is described in detail in the section corresponding to this system (equipment).

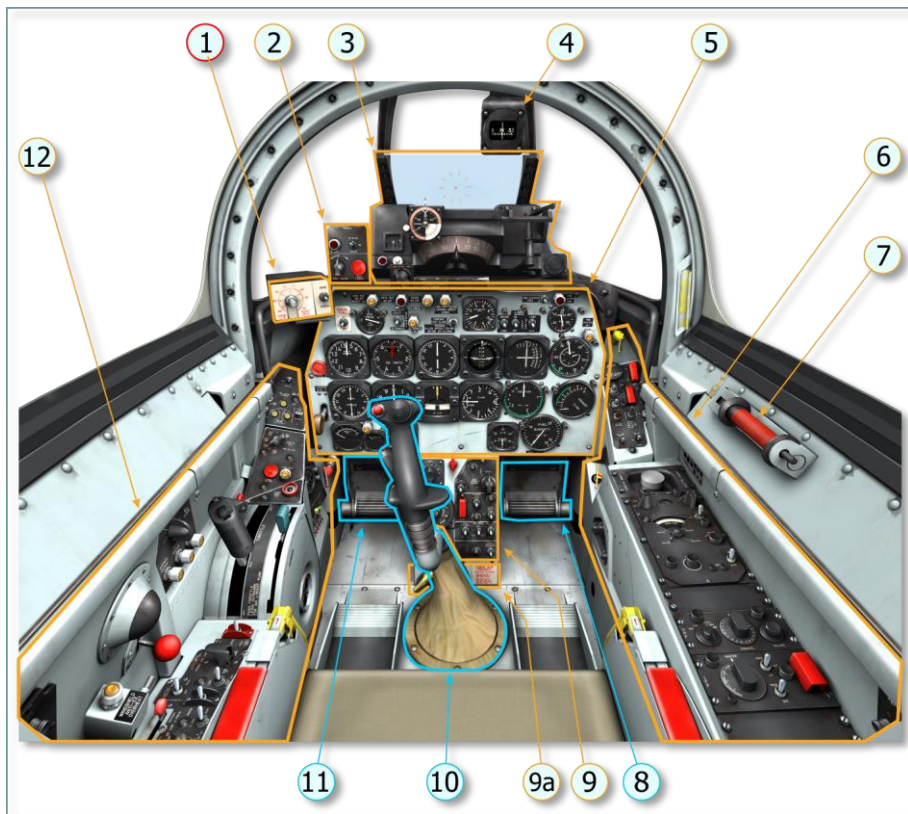
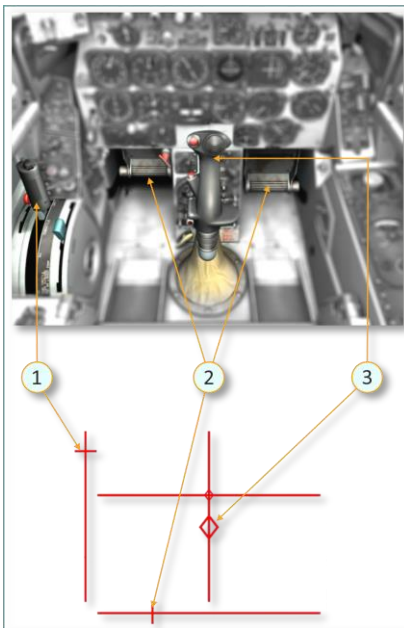

Figure 4.1. F-86F cockpit

1. [Manual pip control unit](#)
(bombing system control panel)
2. [Missile control panel](#)
3. [A-4 sight](#)
4. [Magnetic compass](#)
5. [Instrument panel](#)
6. [Cockpit right side](#)
7. [Canopy manual operating handle](#)
8. [Right pedal](#)
9. [Center pedestal](#)
- 9a. [Emergency control panel](#)
10. [Flight control stick](#)
11. [Left pedal](#)
12. [Cockpit left side](#)

4.1. Aircraft and engine controls

The primary aircraft controls are the flight control stick, the engine throttle, and the pedals ([Figure 4.2](#)).



1. Engine throttle and its position indication
2. Pedals and their position indication
3. Flight control stick and its position indication

Figure 4.2. Aircraft controls and their indication on the screen

In flight, the aircraft control position indicator can be turned on/off using the key combination **[RCtrl + Enter]**. The indicator is displayed in the lower right part of the screen.

4.1.1. Flight control stick

The flight control stick is used for roll control (left and right movements) to make turns and for pitch control (forward and aft movements) to climb and descend.

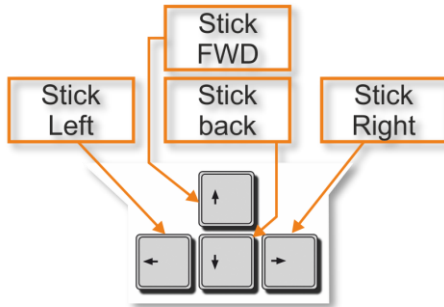

The B-8A flight control stick grip incorporates the following switches:

- Bomb-rocket release button – for firing rockets and releasing bombs
- Two-stage gun trigger – first detent for activating the gun camera, second detent for firing guns and launching missiles
- Radar target selector button – for selecting targets on the radar
- Nose wheel steering button – for engaging the NWS system
- Normal trim switch – five-position thumb-actuated switch for normal control of longitudinal and lateral trim



1. [Bomb-rocket](#) release button
2. [Gun](#) and [missile](#) trigger
3. [Radar target selector button](#)
4. Nosewheel steering button **[S]**
5. [Normal trim switch](#)

Figure 4.3. Flight control stick grip with buttons

4.1.2. Engine throttle

The purpose of the engine throttle, located on the left side of the cockpit, is to control engine thrust and, respectively, the airspeed.

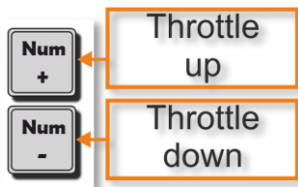

The following aircraft systems and weapon control elements are located on the throttle:

- Microphone button – for radio station transmission control
- Rotating grip – for sight manual ranging, i.e. manual input of target range into the gunsight by rotation of the grip
- Speed brake switch – for speed brake extension and retraction
- Sight electrical caging button – for electrical caging of the gunsight gyroscope



1. [Microphone button](#)
2. [Rotating grip](#)
3. [Speed brake switch](#)
4. [Sight electrical caging button](#)

Figure 4.4. Controls on engine throttle grip

4.1.3. Pedals

The pedals are used for left and right rudder control (yaw control) to counter sideslip or to balance the aircraft in case of asymmetric loading with external stores.

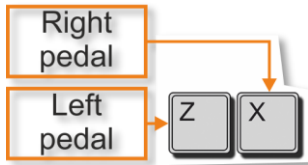

On the ground they are used for nose wheel steering (NWS) during taxi when the nose wheel steering mechanism is on. The mechanism is on when the nose wheel button [S] on the control stick is pressed and held down. When the button is released, the nose wheel goes to self-castoring mode.



Figure 4.5. Nose wheel steering mechanism

Note. To engage the NWS system, the NWS button has to be pressed and the rudder pedals must be aligned in the direction the nose wheel is turned, i.e. the nose wheel has to be “caught” with the rudder pedals for synchronization (when nose wheel and rudder pedals are coordinated in this manner, the nose wheel steering unit is automatically engaged). Note that the wheel can be in a position outside of rudder pedal authority and can not be caught at all. The nose wheel unit will not engage if the nose wheel is more than 21° either side of the center. Should the nose wheel be turned more than this, it must be brought into the steering range by use of the wheel brakes.

4.2. Instrument panel

The instrument panel is one of the main cockpit elements and informs the pilot about the aircraft flight mode and the status of aircraft systems. It also hosts controls of some systems.



Figure 4.6. F-86F-35 instrument panel

1. [Hydraulic pressure gauge](#)
2. [Main instrument](#) (three-phase) inverter failure warning light
3. [Hydraulic pressure gauge selector switch](#)
4. [Both instrument](#) (three-phase) inverter failure warning light
5. [Alternate-on warning light](#) (flight control alternate hydraulic system)
6. [Main radar](#) (single-phase) inverter failure warning light
7. [Directional indicator](#) (slaved)
8. [Trim tab take-off position indicator](#) light
9. [Directional indicator](#) (slaved) [fast slaving button](#)
10. [Accelerometer](#)
11. [Attitude indicator](#)
12. [LABS switch panel](#)
13. [LABS dive-and-roll indicator](#)
14. [Fire-warning light test button](#)
15. [Oil pressure gauge](#)
16. [Fire-warning lights](#)
17. [Tachometer](#) (turbine RPM indicator)
18. [Exhaust temperature](#) (EGT) gauge
19. [Fuel flow meter](#)
20. [Fuel quantity gauge](#)
21. [Cabin pressure altimeter](#)
22. [Vertical velocity indicator](#)
23. [Turn-and-slip indicator](#)
24. [Altimeter](#)
25. [Clock](#)
26. [Loadmeter](#)
27. [Generator](#) (off) warning light
28. [Voltmeter](#)
29. [Landing gear handle](#)
30. [Radio compass](#) (ADF) indicator
31. [Airspeed indicator](#) (knots)
32. [Landing gear emergency retraction button](#)
33. [Machmeter](#) (Mach number indicator)
34. [Emergency fuel switch](#)

4.2.1. Hydraulic pressure gauge



The hydraulic pressure gauge, labeled HYD PRESS, is located on the top left of the instrument panel. This instrument indicates fluid pressure in the hydraulic system selected by the hydraulic pressure gauge selector switch, measured in pounds per square inch (PSI). 1,000 PSI equals approximately 70 kg/cm². The instrument is graduated from 0 to 4,000 PSI and scaled to 100 PSI throughout.

4.2.2. Main instrument (three-phase) inverter failure warning light



The amber, push-to-test type main inverter warning light is mounted on the instrument panel. It is illuminated by power from the primary bus when the main instrument (three-phase) inverter fails. When the light comes on, the alternate three-phase inverter should be selected by moving the instrument power switch to ALTERNATE (ALT). The light will remain on as long as the instrument power switch is at the ALTERNATE (ALT) position.

4.2.3. Hydraulic pressure gauge selector switch



The three-position hydraulic pressure gauge selector switch is located to the right of the hydraulic pressure gauge. It connects the hydraulic pressure gauge to one of the three hydraulic lines – utility, normal, or alternate. When the switch is set to **UTILITY** (utility hydraulic system), **NORMAL** (flight control normal hydraulic system), or **ALTERNATE** (flight control alternate hydraulic system), the pressure of the respective system is indicated by the pressure gauge. The hydraulic pressure indicating system is powered by the three-phase AC bus.

4.2.4. Both instrument (three-phase) inverter failure warning light



This red warning light indicates failure of both three-phase inverters. If the alternate three-phase inverter fails (after being selected by means of the instrument power switch), the both instrument inverter failure warning light will come on. The light, located on the instrument panel, is of the push-to-test type and is powered by the primary bus. See the [power supply system](#) for more information.

4.2.5. Alternate-on warning light



The amber alternate-on warning light, mounted on the instrument panel, illuminates when hydraulic system consumers are switched to the alternate hydraulic system. It is illuminated whenever the flight control alternate hydraulic system is operating. The primary bus normally provides power for illuminating the light. However, if no primary bus power is available, the light will be illuminated by power from the battery bus.

4.2.6. Main radar (single-phase) inverter failure warning light



Failure of the main radar (single-phase) inverter is indicated by illumination of the amber main radar inverter failure warning light, located on the upper instrument panel. The light is of the push-to-test type and is powered by the primary bus.

Note. There is no alternate source of single-phase power.

4.2.7. Directional indicator (slaved)



The V-8 slaved directional (gyro) indicator, located on the instrument panel, is a navigation device that shows the aircraft's current magnetic heading in a range of 0 to 360 degrees. In the above figure, the device is showing a heading of 226 degrees.

This system is called a "slaved" system because the indicated heading on the "master" directional indicator is "slaved" to the aircraft's magnetic heading which is determined by a magnetic sensor called a "flux gate" or "flux valve". The directional indicator is connected to a remotely located magnetic compass and is automatically fed directional signals by the flux valve transmitter. The flux valve continuously senses the earth's magnetic field and a servo mechanism constantly corrects the heading indicator.

Because the compass is gyro-synchronized to the earth's magnetic meridian, the directional indicator indicates magnetic headings without oscillation, swinging, or northerly turning error. The directional indicator automatically indicates the magnetic heading of the airplane by means of a transmitter in the left wing, just inboard of the tip. The transmitter and its associated flux gate are mounted remotely in a wingtip to minimize magnetic interference. This transmitter "senses" the south-north flow of the earth's magnetic flux. Electrical power for the directional indicator is provided when DC power from the primary bus and 400-cycle, three phase AC power is available. The gyro is energized when the battery-starter switch is moved to BATTERY and is on a fast slaving

cycle for the first 3 to 4 minutes of operation, during which it should align with the magnetic heading. The gyro then begins a slow slaving cycle. A switch allows pilot selection of the fast slaving cycle, to permit faster magnetic heading recovery.

Note. After the gyro reaches its operating speed, the indicator should be checked against the standby compass indication to make sure the indicator does not show a 180° ambiguity. The directional indicator is not operating properly if such ambiguity exists.

A knob at the lower left of the indicator permits the indicator course index to be rotated to a preselected heading. Indicator readings will be incorrect if the airplane exceeds 85° of climb or dive or banks left or right more than 85°. Error in heading indication when the airplane is in an extreme bank or roll movement is an inherent characteristic of the gyro; however, it disappears when the airplane returns to straight and level flight. An additional error, however, will build up in the indication during turns. This is caused by centrifugal force which tends to swing the transmitter flux valve into the vertical component of the earth's magnetic field. The amount of error is proportional to time and duration of the turn. Therefore, errors will result in the indicator during turns, banks, or rolls. The fast slaving button may be actuated after the maneuvers are completed so as to correct the heading indication at the fastest possible rate.

4.2.8. Trim tab take-off position indicator light



The primary-bus powered amber light on the instrument panel indicates take-off trim positions of the ailerons, horizontal tail, and rudder (see [Figure 5.1](#)). The light will come on whenever any one of these control surfaces is trimmed to its take-off position ([see HERE for details](#)). The light will go out when the respective trim switch is released. It will come on again as each subsequent control is trimmed for take-off.

Note. Only the normal trim switch will cause the light to indicate proper take-off trim.

The take-off trim position for the ailerons and rudder is neutral while the take-off trim position for the horizontal tail is set for a nose-up condition.

4.2.9. Directional indicator (slaved) fast slaving button



The fast slaving button, located on the instrument panel and labelled COMPASS FAST SLAVE, is used to quickly eliminate strong misalignment between the sensor and the gyro unit by restoring the gyro to its erect and slaved position in level flight. This re-alignment is necessary after maneuvers in which the gyro has hit its mechanical stops. For example, one minute of aerobatic maneuvering can cause 3 - 4° of misalignment.

When the fast slaving button is released, fast slaving of the compass system will occur, thus providing a faster time for true heading recovery. That is, the slaving torque motor will start to precess the gyro at a rate of 60-90°/min instead of the usual 4-5°/min slow slaving rate.

During normal flight, the directional indicator should be followed instead of the standby compass as long as indications from the standby compass and the directional indicator are roughly identical. If a considerable difference exists between both indications, the directional indicator should be realigned by flying straight and level and pressing the fast slaving button.

The fast slaving cycle of the directional indicator can be initiated either through the pushbutton type switch on the instrument panel or through the one on the right forward console. Both switches are powered by the primary bus. Depressing either button momentarily de-energizes the slow slaving cycle of the magnetic compass system. When the button is released, the fast slaving

cycle is engaged to permit faster gyro recovery to the magnetic heading of the airplane. The fast slaving cycle is engaged for 2 or 3 minutes after which it returns to slow slave.

Caution. Excessive use of the fast slaving button can damage the slaving torque motor. As indicated on the label below the button, a minimum of 10 minutes should elapse between each successive use of the fast slaving switch.

N o t e . The fast slaving button should not be used during flight, except when the aircraft can be maintained in straight-and-level, non-accelerated flight for at least three minutes after the fast slaving button is depressed. After the fast slaving button is pressed, a time delay circuit maintains the fast slave action for approximately 2 to 3 minutes. During this interval, any maneuvering of the aircraft can induce errors in the equipment. After the completion of this interval, the system normally reverts to slow slave and any large errors which have been introduced will remain for a considerable time.

N o t e . Since the gyro automatically enters a fast slaving cycle after becoming energized, manual activation of the fast slaving cycle during cold start is not necessary.

4.2.10. Accelerometer

A Burton B6 three-pointer accelerometer, located on the instrument panel, indicates positive and negative G-loads, i.e. the load on the airframe in terms of gravitational (G) units. The accelerometer incorporates three pointers (one main and two recording). The main pointer indicates existing acceleration while the two recording pointers record the highest positive and negative G-loads experienced by the aircraft. The recording pointers follow the main pointer to its maximum travel. They then remain at the respective maximum travel position, thus providing a record of maximum G-loads encountered. To return the recording pointers to the normal (1 G, equal to one times the force of gravity) position, it is necessary to press the accelerometer reset knob labeled PUSH TO SET which is located on the lower left corner of the instrument ring.

The F-86 carries a single-axis accelerometer that, in contrast to multi-axis accelerometers, indicates acceleration through the vertical axis (aligned with the pilot's spine) only, thus providing normal G-load (load factor) information. The indicated value is defined as the ratio of the lift of the aircraft to its weight.

When the aircraft is stationary on the ground, the accelerometer reads +1 since the upward-pointing ground reaction force of the surface counteracts the downward-pointing gravitational force to keep the aircraft balanced.

When the aircraft is in straight-and-level upright flight, the accelerometer also reads +1 since now the upward-pointing force of aerodynamic lift is counteracting the downward-pointing force of weight to keep the airplane balanced and prevent it from free-falling.

The accelerometer reads -1 G in straight-and-level inverted flight.



1. Accelerometer reset knob
2. Current G-load pointer
3. Maximum negative G-force recording pointer
4. Maximum positive G-force recording pointer
5. Negative G-limit
6. Positive G-limit (no external load)
7. Positive G-limit (with external load)

The gauge is graduated from -5 to +10 G and scaled to 0.5 G throughout. The two red markings indicate maximum allowable positive and negative G-loads of -3 and +7 G respectively.

When external stores are equipped, the maximum allowable positive G-load is reduced to approximately +5 G, as indicated by a red-amber marking on the instrument. Note that this is only a rough estimate and the exact acceleration limit depends on the specific external load carried.

4.2.11. Attitude indicator

The gyro-controlled J-8 attitude indicator, installed on the F-86F-35, provides a visual indication of the flight attitude of the airplane in pitch and roll. In the J-8 indicator, the aircraft symbol is fixed while the artificial horizon line moves (pitches and rolls).

The unit is electrically operated (three-phase AC) and has an "OFF" indicator flag which appears in the upper right arc of the dial whenever power is not being supplied or the gyro is not up to speed.

Within a range of 27° in a climb or dive, the pitch attitude of the airplane is indicated by displacement of the horizon bar in relation to the miniature aircraft. When the pitch attitude of the airplane exceeds 27°, the horizon bar remains in the extreme position and the sphere then serves as the reference. If the climb or dive angle is further increased with the airplane approaching a vertical position, the attitude is indicated by graduations on the sphere.

The attitude indicator is equipped with a dive angle indicating scale which is used to indicate the airplane's dive angle when the manual pip control system is used. A precession of 180° occurs when the airplane approaches 90° in pitch. This is a controlled precession and not an error with the instrument.

In a roll, the attitude of the airplane is shown by the angular setting of the horizon bar with respect to the miniature aircraft and by the relation of the bank pointer to the degree markings on the bezel mask (immovable bank scale).

The gyro may be manually caged by use of the caging knob on the lower right side of the bezel. Caging is accomplished by smoothly pulling the knob away from the instrument and releasing it quickly as soon as it reaches the limit of travel. The manual caging feature permits fast gyro erection for scramble take-offs or for erecting the gyro to correct in-flight errors caused by turns or aerobatics. For scramble take-offs, 30 seconds should be allowed after power is applied to bring the gyro up to speed, and then the gyro should be caged immediately. The gyro should be caged to correct in-flight errors only when the airplane is in straight and level flight as determined by visual reference to the true horizon. This ensures that the attitude indicator reflects the true attitude of the airplane. A knob on the lower left side of the bezel permits the miniature aircraft to be adjusted to compensate for longitudinal trim changes.



The structural elements of the attitude indicator are shown in the figure below.

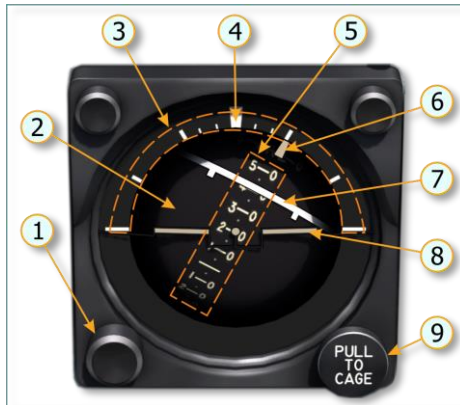

1. Pitch trim knob
2. Attitude sphere
3. Bank scale
4. Aircraft vertical axis marker
5. Pitch scale
6. Bank pointer
7. Horizon bar
8. Miniature aircraft
9. Caging knob

When the attitude indicator is off, there is an OFF flag in the upper visible part of the instrument:



Attitude indicator operation

A special feature of this instrument is the movable horizon bar, a line representing the artificial horizon. To indicate pitch, the line moves in the direction opposite to aircraft's movement (i.e. if the aircraft's nose is moved down, the horizon bar goes up). The horizon bar has no roll component (always stays parallel with the miniature aircraft symbol) therefore a rolling aircraft has no effect on it. The relative position of the aircraft and the attitude sphere (a sphere with a gyroscope), which is immovable relative to the ground, can be represented as in [Figure 4.7](#) (colored for illustration purposes).

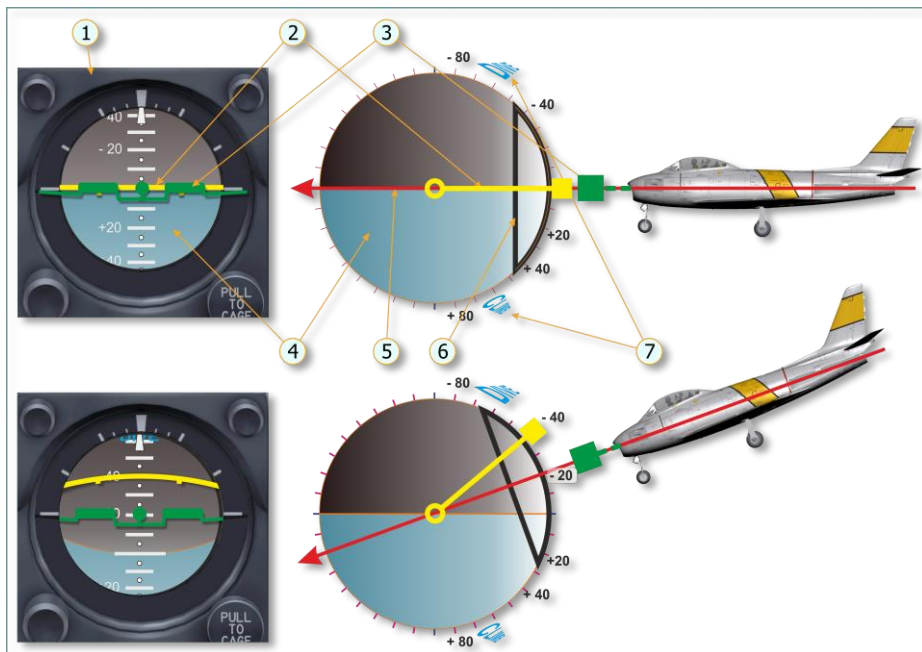

Figure 4.7 F-86 artificial horizon operation principle

1. Instrument housing
2. Horizon bar (yellow) – artificial horizon line, movable relative to ground and aircraft
3. Miniature aircraft (green) – aircraft symbol, immovable relative to aircraft
4. Attitude sphere (blue/gray) – immovable relative to ground (i.e. the aircraft rotates around it)
5. Aircraft speed vector
6. Part of the attitude sphere visible to the pilot

7. CLIMB and DIVE indices with numbers on the sphere

The horizon bar shows the position of the miniature aircraft relative to the horizon. As can be seen in [Figure 4.7](#), it moves along the pitch scale relative to both the aircraft and the ground. For example, when the aircraft is in a 5° dive (-5° pitch), the scale goes to $+5^\circ$ relative to the fuselage waterline, which means $+10^\circ$ relative to the ground. In the example shown in the lower part of the figure, the miniature aircraft is lower than the horizon bar which means the aircraft is in a dive. The deviation angle of the horizon bar from the aircraft's horizontal plane is equal to the pitch angle, but only up to $\pm 27^\circ$. Beyond this value, the horizon bar no longer moves in order to stay in the visible part of the instrument. It must be kept in mind that the real pitch angle is indicated under the center point of the stationary miniature aircraft and not under the horizon bar. An example of the relative position of the instrument elements and the aircraft is shown in [Figure 4.8](#) where the bottom of the page represents the ground.

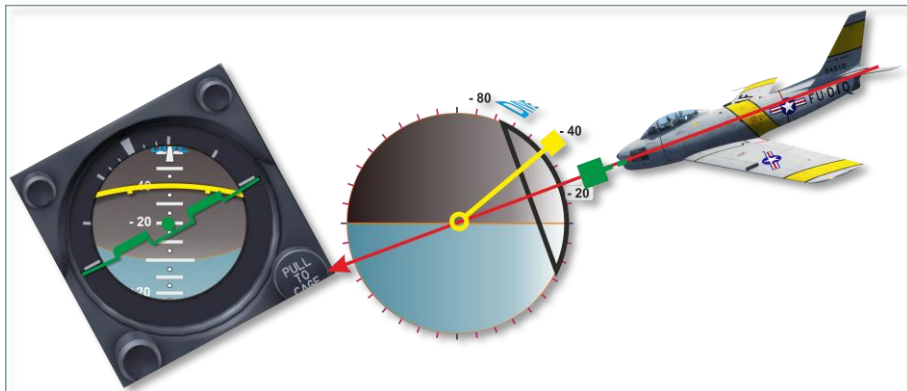



Figure 4.8. Relative position of the instrument and its elements in a 20° dive and 30° left turn

[Figure 4.9](#) shows both cockpit view and real instrument indication of the above situation (20° dive / -20° pitch, 30° left turn).



Figure 4.9. Attitude indicator reading in a 20° dive and 30° left turn

When the pitch angle reaches approx. $\pm 90^\circ$, the sphere turns upside down. The horizon bar has two marks. In normal non-inverted flight, these marks are underneath the line: .

In inverted flight, they are on top of the line: .

4.2.12. LABS switch panel



The LABS switch panel is for LABS mode control. See [here](#) for details.

4.2.13. LABS dive-and-roll indicator

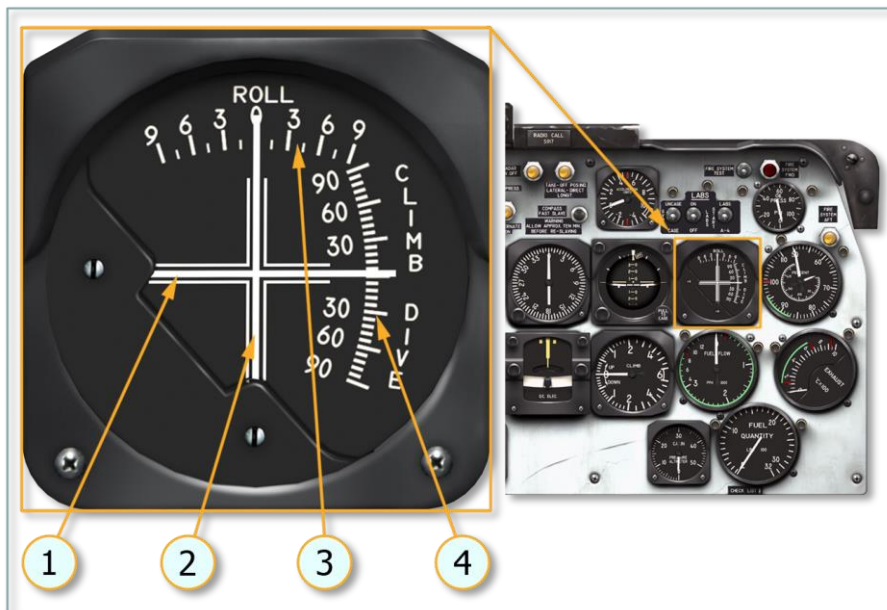

1. Indicator for pitch deviation from preset value
2. Indicator for roll deviation from preset value
3. Roll deviation scale
4. Pitch deviation scale

The LABS dive-and-roll indicator, a dual-movement, zero-centered unit, mounted on the instrument panel under the LABS switch panel, shows the aircraft attitude during LABS bombing. The vertical pointer indicates airplane roll attitude while the horizontal pointer shows airplane pitch attitude. The dive-and-roll indicator is operable when the change-over switch is set to LABS and the gyro caging switch is set to UNCAGE. When the caging switch is set to CAGE, both indicator pointers should indicate zero.

4.2.14. Fire-warning light test button



Continuity of the engine section fire detector system and operation of the fire-warning lights can be checked by means of the fire-warning light test button. To perform the test, press the button for 10 seconds - both lights should illuminate within 10 seconds.

Note that this button only allows a continuity test to be performed. It does not test for correct polarity wiring of the individual detector thermocouples nor does it check for correct resistance.

Before testing the system, check the fire-warning lights for bulb illumination by pushing the press-to-test lights on the right side of the instrument panel.

4.2.15. Oil pressure gauge



The B-20 oil pressure gauge, labelled "OIL PRESS." and located in the upper right corner of the instrument panel, registers engine oil pressure in pounds per square inch (PSI).

The instrument is graduated from 0 to 100 PSI and scaled to 5 PSI throughout. It has a red marking at 1 PSI, the minimum oil pressure in idle mode. The green marking from 8 to 18 PSI indicates the normal operating range at 88% engine RPM (thrust). The red marking at 22 PSI indicates maximum oil pressure at 100% engine RPM (thrust).

The electrically operated gauge receives power from the three-phase AC bus.

4.2.16. Fire warning lights



The red light indicates that fire has been detected in the engine forward section.



The amber light indicates that fire has been detected in the engine aft section.

4.2.17. Tachometer



The tachometer, located on the instrument panel, indicates turbine RPM. It registers engine speed in percentage of maximum rated RPM (100% corresponds to 7950 RPM). This indication, when used in conjunction with that of the exhaust temperature gauge, permits engine thrust to be accurately set without exceeding engine limitations. The tachometer receives its power from the tachometer generator, which is geared to the engine rotor shaft, and therefore does not depend on the airplane's electrical system.

RPM above 50% is indicated by a long pointer on the outer portion of the dial. To allow a better precision of readings at engine start, a short needle on the inner portion of the dial indicates RPM up to 50%. Idle RPM is in the range of 32-34%.

4.2.18. EGT gauge



The exhaust gas temperature (EGT) gauge, located on the instrument panel, indicates engine exhaust temperatures in degrees Celsius – an important criterion for assessing engine health status and its current operating mode. Gauge indications are received from bayonet-type thermocouples mounted in the forward section of the tail pipe. The temperature indicator system is of the self-generating type and, as such, does not require power from the airplane's electrical system.

Note. The gauge is rotated to position the 690°C red radial, used to indicate maximum stabilized RPM / military thrust, at the top (12 o'clock position) to allow a more accurate reading of the gauge.

4.2.19. Fuel flow meter



The fuel flow meter, located on the instrument panel, indicates the rate of fuel flow in 1,000 thousands of pounds per hour (PPH, or lb/hr). It is used to check proper fuel flow in the different flight modes.

The gauge is graduated from 0 to 12,000 PPH and scaled to 100 PPH from 0 to 3,000 PPH and to 1,000 PPH thereafter. It has two red markings at 200 PPH and 9,000 PPH indicating minimum and maximum fuel flow respectively. The green range between 200 to 9,000 PPH indicates continuous fuel flow.

The flow meter system is operated by single-phase AC power.

4.2.20. Fuel quantity gauge



The fuel quantity gauge, mounted on the instrument panel, allows you to monitor the remaining fuel quantity. It indicates the total internal fuel supply in pounds as determined by a densitometer-type indicator system which receives power from the primary bus. It automatically compensates for changes in fuel density so that the quantity gauge will register the actual number of pounds of fuel regardless of the type of fuel used and regardless of fuel expansion or contraction caused by temperature changes. (Noncompensating systems, although calibrated in pounds, are based on volume and therefore do not provide an accurate indication of fuel weight).

The densitometer system incorporates a selector switch to provide uncompensated gauge indications when desired.

The gauge is graduated from 0 (labelled "E" for empty) to 3,200 lbs and scaled to 100 lbs throughout.

N o t e . There is no separate fuel quantity gauge for drop tanks.

N o t e . When drop tanks are carried, the fuel quantity gauge will not indicate a decrease in fuel supply until the drop tank fuel has been consumed and the engine begins to use internal fuel.

4.2.21. Cabin pressure altimeter



The MA-1 cabin pressure altimeter located on the instrument panel, indicates the pressure altitude of the cockpit in thousands of feet.

This altimeter operates similarly to the flight altitude altimeter, but is vented only to pressure within the cockpit.

Pressurization is the creation of additional pressure in the cockpit through the supply of additional air from the compressor. This results in a more comfortable environment for the pilot when the plane is flying in high altitudes with thin air. The increase of cockpit pressure lowers the altitude reading on the altimeter if the altimeter is supplied by the cockpit pressure.

4.2.22. Vertical velocity indicator



The vertical velocity indicator (VVI) indicates the aircraft's rate of climb or descent.

The instrument is graduated from 0 to 6,000 ft in both positive and negative directions and indicates vertical speed in feet per minute (fpm). The face is scaled to 100 ft between 0 and 1,000 ft, to 200 ft between 1,000 and 2,000 ft, and to 500 ft thereafter.

The VVI is used to maintain a constant altitude when turning and to establish a definite and constant rate of climb or descent when flying on instruments.

Note. If the needle is pointing to "1", the instrument is indicating a rate of 1,000 feet per minute (approx. 5 m/s).

4.2.23. Turn-and-slip indicator



1. Turn indicator

2. Slip indicator (inclinometer)

The conventional C-6 turn-and-slip (T/S) indicator, located on the instrument panel, is electrically driven by power from the primary bus. A T/S indicator is a two-in-one flight instrument that houses both a turn indicator and a slip indicator.

The gyroscope-operated turn indicator registers angles of turn instantaneously as they are made and indicates rate of turn about the aircraft's vertical (yaw) axis, i.e. the rate of change in the aircraft's heading. The instrument's face contains markings for the pilot's reference during a turn. When the needle is lined up with one of the two "4 min turn" indices (sometimes called "dog houses" because of their distinct shape), the aircraft is performing a half standard rate turn – a turn at 1.5° per second, taking four minutes for a complete 360-degree circle.

The ball-type sideslip indicator (inclinometer) displays slip or skid both during level flight and during a turn, thus indicating whether the aircraft is in coordinated flight or not. Slip or skid occurs when the aircraft's vertical axis deviates from the direction of gravity in straight flight or from the resultant

direction of gravity (the resultant of the vectors for centrifugal force and gross weight) in a turn. The inclinometer is a liquid-filled, curved glass tube in which a free-rolling ball changes position (i.e. moves left and right) according to force of gravity and centrifugal force. The liquid in the tube keeps the ball from moving too abruptly. During straight and level flight, the aircraft's vertical axis aligns with the direction of gravity and the ball remains in the center of the inclinometer. During a coordinated turn, the aircraft's vertical axis aligns with the resultant direction of gravity and the ball, again, remains in the center of the inclinometer. During an uncoordinated turn, the aircraft's vertical axis does not align with the resultant direction of gravity and the ball inside the inclinometer is offset. The pilot uses the inclinometer to minimize sideslip by keeping the ball centered between the center reference lines while turning.

4.2.24. Altimeter

The AN5760 MB-1 type altimeter indicates barometric flight altitude in feet using three pointers: a long 100-foot pointer, a short, thick 1,000-foot pointer and a thin 10,000-foot pointer with a marker on the end.

The altimeter offers improved readability with an extension added to the 10,000-foot pointer so that it cannot be obscured by the other pointers.

The altimeter also has a built-in low altitude warning system that visually warns the pilot when flying at potentially dangerous altitudes below 16,700 feet. The warning increases with decreasing altitude.

The low altitude warning system is comprised of two parts – 1) a movable, notched disk and 2) a fixed, striped segment called the low altitude warning sector. The notched disk is incorporated with the 10,000-foot pointer and rotates with the pointer as altitude changes. When the pointer moves an increment of 10,000 feet, e.g. from the "0" to the "1" position, the disk is rotated by 36°. A 60° sector of the disk between the 150° and 210° positions is cut out to reveal the space below it which will, depending on the altitude, show all, none, or some of the low altitude warning sector

At an altitude of 0 ft, when the 10,000-foot pointer and thus the disk are exactly at the 12 o'clock "0" position, the striped segment is fully visible and the low altitude warning is most prominent. With increasing altitude, the striped segment starts to gradually disappear as the rotating disk covers it while turning clockwise with the 10,000-foot pointer. At an altitude of approximately 8,300 ft, half of the striped segment is hidden. At altitudes above 16,700 ft, the striped segment is fully concealed. The notched disk will start to gradually

expose the warning stripes again when the aircraft is descends back down through 16,700 ft.

The AN5760 is actually an aneroid barometer calibrated to indicate altitude instead of barometric pressure. It gives a visual indication of barometric height by detecting changes in atmospheric pressure as the aircraft climbs or descends. It is a so-called sensitive altimeter that measures the absolute ambient air pressure and displays it in feet above a selected reference pressure level.

The reference pressure from which the altitude is measured can be set with the altimeter reference pressure adjusting knob in the lower left portion of the instrument. When the knob is rotated, it moves an adjustable barometric scale in a small window on the right side of the face named the "Kollsman window" (after Paul Kollsman who invented the world's first accurate barometric altimeter). The scale is graduated from 28.0 to 31.0 inches of mercury (inHg) (948 to 1,050 millibars) and scaled to 0.01 inHg throughout. The set reference pressure is indicated left of the small white notch (29.90 inHg in the figure below).



Although there are many different ways to set the reference pressure, the following three so-called "Q codes" are the most common:

QFE – atmospheric pressure at aerodrome elevation (or runway threshold). The altimeter is referenced to the atmospheric pressure at a specific location (elevation of airfield, runway threshold, port, oil rig, etc). With QFE set in the Kollsman window, the altimeter will read zero at the (airfield) reference point or the touch-down zone of the runway in use and its indication is referred to as "height". QFE is mostly used near an airfield, particularly during traffic patterns.

QNH – altimeter subscale setting to obtain elevation when on the ground. The altimeter is referenced to the barometric pressure measured at a station and adjusted to mean sea level (MSL) pressure, i.e. QNH is QFE reduced to MSL under ISA conditions. The altimeter will display the airfield's elevation above MSL on the airfield's tarmac. This is the most commonly used pressure setting in commercial aviation since most references to elevation (e.g. mountain peaks

on maps, airfield elevation, minimum safe altitudes) are in relation to MSL. With QNH set on the altimeter, its indication is referred to as "altitude".

QNE – altimeter referenced to the ISA (International Standard Atmosphere) model's standard atmospheric pressure at sea level – 29.92 inHg (1,013.25 mbar or hPa), which is the average atmospheric pressure at sea level around the globe. This so-called "standard" pressure setting is set from QNH when climbing up through the "transition level". With QNE set on the altimeter, its indication is referred to as "pressure altitude" expressed in flight levels. An altimeter reading of 27,000 ft is referred to as flight level 270 (FL270), 6,000 ft as FL060, and 14,500 ft as FL145.

In the example below, the altimeter shows an altitude of 11,180 ft.



1. Altimeter reference pressure adjusting knob
2. Rotating notched disk (visually warns the pilot when current altitude is less than 16,700 feet)
3. 1,000-foot pointer (indicated value to be multiplied by 1,000)

4. 100-foot pointer (indicated value to be multiplied by 100)
5. 10,000-foot pointer (indicated value to be multiplied by 10,000)
6. Kollsman window (indicating reference pressure, 29.78 inHg in the above figure)

4.2.25. Clock

The Waltham A-13A aircraft chronograph, installed in the lower section of the instrument panel, displays the current time and can also be used as a stopwatch to accurately measure short periods of time (up to an hour). The mechanical clock runs for 8 days on a single winding.



1. Clock winding and setting knob
2. Clock minute hand
3. Stopwatch second hand
4. Stopwatch scale

5. Clock hour hand
6. Stopwatch minute hand
7. Elapsed time knob
(to start/stop/reset stopwatch)

CLOCK FUNCTION.

The winding and setting knob, located in the lower left-hand corner of the clock case, has two functions: First, it winds the mainspring of the clock when rotated clockwise until a stop is reached. The clock is an "8 day" clock, i.e. after being fully wound, the clock shall operate for a minimum of 8 days (192 hours) before stopping. Second, it is used to set the time (hour and minute hands) when pulled out into the setting position. In the simulation, at mission start, the clock is automatically set to the pre-set time. Therefore, there is no need to set the clock manually. To adjust the time anyway, perform the following steps:

- Pull the winding and setting knob (1) out into the setting position by right-clicking it or pressing **[RShift + C]** - this stops the clockwork;



- Set the desired time by rotating the knob with the mouse wheel;
- Push the knob in again by right-clicking it or pressing **[RShift + C]** - this starts the clockwork again.

STOPWATCH FUNCTION.

The stopwatch can be used to measure the duration of a flight. The elapsed time knob (7), located in the upper right-hand corner of the clock case, operates the three phases of the clock's elapsed time function as follows:

- When the stopwatch minute and second hands are at rest at 60 on the dial (the so-called "zero triangle"), pushing the knob causes them to start;
- If the hands are moving, pushing the knob causes them to stop;
- If the hands are stopped elsewhere on the dial other than at 60, pushing the knob causes them to fly back to 60 (reset). On the fly-back or zero push, both the stopwatch minute and second hands return to the zero triangle and remain at this position until the knob is pushed for the starting function.

To start, stop, or reset the stopwatch, press the elapsed time knob by left-clicking it or pressing **[LAlt + S]**.



4.2.26. Loadmeter



The loadmeter, located on the bottom left of the instrument panel, is marked LOAD and indicates the percentage of total system amperage being used.

The loadmeter is an ammeter that shows how much work the electrical system is doing and indicates the load on the electrical system in percentage of maximum load.

4.2.27. Generator (off) warning light



The red generator warning light, located on the bottom left on the instrument panel, is illuminated by primary bus power when the generator fails, if generator voltage drops below that required to close the reverse-current relay, or when the generator switch is OFF. Also, if generator voltage exceeds 31 V, the generator is automatically cut out of the circuit and the generator warning light comes on. Illumination of the warning light indicates that all equipment powered by the secondary bus is inoperative and that the battery is powering the primary bus; therefore, all other non-essential electrical equipment should be turned off to conserve battery power.

4.2.28. Voltmeter



The voltmeter, located on the bottom left of the instrument panel, provides direct indication of the generator voltage output, i.e. it indicates the actual voltage in the DC circuit.

The gauge is graduated from 0 to 30 V and scaled to 1 V throughout.

4.2.29. Landing gear handle



The landing gear handle, located on the left side of the instrument panel, electrically controls (through primary bus power) the gear and gear door hydraulic selector valve. Moving the handle to UP or DOWN causes utility hydraulic system pressure to position the gear correspondingly. When the gear is down and locked and the weight of the airplane is on the gear, a ground safety switch prevents gear retraction in the case where the control handle is inadvertently moved to UP. The wheel fairing doors are not controlled by the safety switch; therefore they will follow their normal sequence by opening when the handle is moved to UP. As a result, a warning is provided that the landing gear handle is in the wrong position (UP) for ground operation.

The wheel portion of the handle illuminates to serve as the landing-gear-unlocked or door-unlocked warning light.

4.2.30. Radio compass indicator



1. VAR knob (rotates the scale)
2. Pointer (indicates direction to transmitter)

3. Top index (fixed at 12 o'clock position)

The ID91A/ARN6 radio compass indicator, located on the instrument panel, is not a compass per se but only an indicator that has a needle coupled to a synchro motor that is coupled to another mechanism that actually performs the compass function. In the F-86F, it is used in conjunction with the AN/ARN-6 radio compass set – a navigational aid powered from the secondary bus – to determine the direction to a radio transmitter as an aid for flying toward (or away from) a station.

The radio compass indicator is driven by the radio compass and indicates the angular position of the autosyn transmitter located in the loop and gives the bearing of a radio transmitter when the loop is at a true null.

The pointer indicates the relative bearing to the transmitter, i.e. the direction to the desired station relative to the aircraft's nose. The 12 o'clock position (marked by a fixed index, the so-called "top index") represents the nose of the aircraft and the 6 o'clock position the tail. The relative bearing, the angle

measured clockwise from the nose of the aircraft to the station, is indicated by the needle. If the needle points straight up, the aircraft is flying towards the transmitter. When the needle swings around 180 degrees, the transmitter has just been overflowed.

When the true magnetic heading of the aircraft is set under the top index, the pointer will indicate the magnetic bearing to the station instead of the relative bearing. The indicator's bearing scale can be manually rotated with the knob labeled "VAR." located on the front of the indicator.

The bearing scale is graduated every two degrees with every 30-degree graduation indicated by the proper numeral.

4.2.31. Airspeed indicator

The L-7A pitot static airspeed indicator is a conventional indicator but with the addition of a red and yellow limiting hand. The instrument has two pointers:

The white indicated airspeed pointer indicates current airspeed in knots.

The red and yellow limiting hand, or maximum speed pointer, has two adjustments. The first adjustment allows a limit Mach number to be set. This adjustment is indicated by the position of a small triangular index marker on the Mach scale along the circumference of the dial and causes the maximum speed pointer to reflect an airspeed corresponding to this limit Mach number. The second adjustment prevents clockwise movement of the maximum speed pointer beyond a limit airspeed. The maximum speed pointer will indicate the airspeed corresponding to either a limit Mach number or limit airspeed, whichever is less, for a given external loading configuration. If there is no airspeed or Mach number limit for the airplane, the hand will reflect the airspeed corresponding to Mach 1.0, the design limit of the instrument. The two pointers are concentric, with the maximum speed pointer below the indicated airspeed pointer.

The dial is graduated from 50 to 650 KIAS and scaled to 10 KIAS throughout. It has a yellow marking at 185 KIAS to indicate maximum gear- and flaps-down airspeed, and a red marking at 600 KIAS to indicate maximum allowable airspeed.

In addition to the pointers, the instrument is equipped with a vernier drum, a rotating disk making one revolution for each 100-knot change in airspeed. It is geared to the indicated airspeed pointer so that proper relationship is maintained at all speeds. Its 2-knot graduations allow precise reading of

airspeed to the nearest knot. The drum indication is read below a triangular index.

The pitot-static head is installed in a boom on the right wing tip, and installation error is negligible so far as the pilot is concerned.



1. Red marking at 600 KIAS, the maximum allowable airspeed
2. Triangular index marker and the Mach scale
3. Maximum speed pointer

4. Vernier drum
5. Indicated airspeed pointer
6. Yellow marking at 185 KIAS, the maximum gear- and flaps-down airspeed

4.2.32. Landing gear emergency retraction button



The guarded landing gear emergency retraction (or “emergency-up”) button, located on the left center portion of the instrument panel, overrides the landing gear ground safety switch and permits the gear to be retracted on the ground.

Warning. To prevent damage to the airplane and to prevent possible pilot injury, do not use this button, except when only one main gear is down and it cannot be retracted through normal procedures (this failure of the retraction system is not implemented in the simulation). In this case, it may be retracted by placing the gear handle in the UP position and depressing the landing gear emergency retraction button.

This button is also used for landing gear retraction during maintenance.

4.2.33. Mach number indicator



The A-2B Mach indicator (also called a Machmeter) serves as a primary flight instrument for indicating speed. It displays the so-called Mach number, named after the late Austrian physicist Ernst Mach, as a decimal fraction.

When fast aircraft, capable of high speed flight, exceed a certain Mach number, shock waves on the aircraft result in undesirable and dangerous effects such as serious buffeting, instability, and control problems. In the early days of supersonic flight, this caused a lot of accidents. These negative effects do not occur at a specific critical airspeed, so the airspeed indicator can not be relied upon to warn of their onset. Instead, the important factor is the ratio of the aircraft's true (not indicated!) airspeed to the local speed of sound, also called the Mach number.

The Mach indicator is extremely valuable, particularly at high altitudes, as its reading is more closely related to true airspeed than is indicated airspeed. For example, at 45,000 ft, an indicated airspeed of 240 knots is actually a true airspeed of 510 knots. This true airspeed is indicated on the Mach indicator as Mach .89 at 45,000 feet or Mach .77 at sea level. Thus, there is a difference of only about one tenth Mach number between 45,000 feet and sea level, while the indicated airspeed varies by 270 knots.

The instrument indicates the dimensionless Mach number M , the ratio of the aircraft's true airspeed V to the speed of sound c at the current flight altitude (i.e. taking into account air density):

$$M = \frac{V}{c}$$

where c decreases with increasing altitude.

The instrument is graduated from 0.5 to 1.5 Mach and scaled to 0.01 Mach throughout. It has a separate marking for the 0 position. An aircraft flying at the speed of sound is flying at a Mach number of one, or "Mach 1".

With the true airspeed being constant, the indicated airspeed decreases with an increase in altitude. The aircraft behavior starts changing as the aircraft approaches $M=0.85$ and beyond. Therefore, the most reliable source of information regarding the airspeed in a range of $M=0.85$ to 1.05 is the Mach number indicator.

4.2.34. Emergency fuel switch



The emergency fuel switch, located on the upper left corner of the instrument panel, allows manual activation of the emergency fuel control system.

With the emergency fuel switch OFF, primary bus power is directed to a solenoid which mechanically holds the emergency fuel regulator in the full bypass position. This makes the emergency system inoperative because the total output of the fuel pump's emergency element is bypassed. Thus, the emergency system is prevented from overriding the main system during normal operation.

Warning. The emergency fuel switch should be OFF for all flight conditions except where actual failure of the main fuel system occurs. When the emergency fuel switch is ON, rapid throttle advancement can cause compressor stall or flame-out.

Warning. If, during engine operation, primary bus power failure occurs or the battery-starter switch is moved to OFF when generator output is not available, the emergency fuel system may take over automatically, regardless of emergency fuel switch position. Subsequent rapid throttle advancement can cause the emergency system to override the main system, resulting in complete power failure as a result of engine overspeeding or compressor stall.

The emergency fuel switch should be maintained at OFF for all flight conditions except in case of actual main fuel control system malfunction. When the emergency fuel switch is at ON, the holding circuit to the emergency regulator is broken and the main fuel system regulator is electrically (DC) disabled, allowing the emergency system to assume control of fuel flow to the engine.

Warning. If RPM is below 80% when the main fuel system fails, do not turn on the emergency fuel switch without first retarding the throttle to IDLE. To do so may cause dangerous engine overheating or compressor stall.

4.3. Cockpit left side

The left side of the cockpit includes the left forward console, drop tank control panel, throttle quadrant, left aft console, rocket intervalometer, oxygen supply control panel, and other elements.

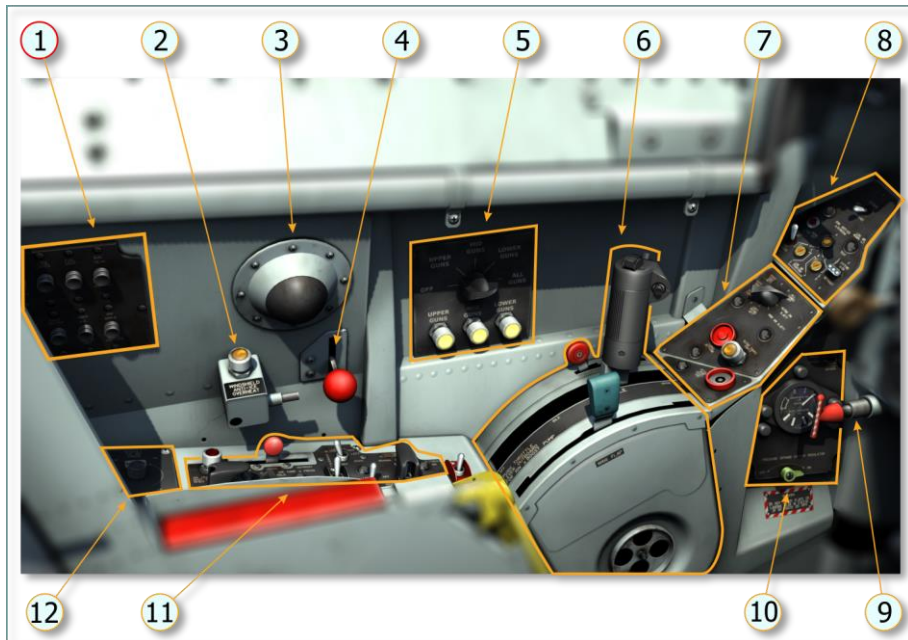

Figure 4.10. Cockpit, left side

- | | |
|---|------------------------------|
| 1. Left circuit-breaker panel | 6. Throttle quadrant |
| 2. Windshield anti-icing overheat warning light | 7. Drop tank control panel |
| 3. Side air outlet | 8. Left forward console |
| | 9. Emergency jettison handle |

- | | |
|--------------------------------|----------------------------|
| 4. Windshield anti-icing lever | 10. Oxygen regulator panel |
| 5. Machine gun control panel | 11. Left aft console |
| | 12. Rocket intervalometer |

(1) *LEFT CIRCUIT-BREAKER PANEL*. Not simulated.

(2) *WINDSHIELD ANTI-ICING OVERHEAT WARNING LIGHT*. The amber indicator light on the left side of the cockpit aft of the side air outlet is powered by the primary bus and comes on whenever the temperature of the air used for windshield anti-icing exceeds the design limit of 275 °F. However, this does not mean the windshield itself is overheated or at immediate risk of damage. An attempt should be made though to reduce windshield air outlet temperature by reducing engine RPM or by placing the cockpit pressure switch at RAM. Even if either action is undesirable or fails to correct the overheat condition, the anti-icing system should be left on to improve forward vision, especially during the landing approach.

(3) *SIDE AIR OUTLET*. Cockpit air outlet. [Pressurization system](#).

(4) *WINDSHIELD ANTI-ICING LEVER*. The windshield anti-icing lever, forward of and below the side air outlet and above the left aft console, controls windshield anti-icing. When moved to ON (up), the lever mechanically positions a valve so that engine compressor air from the primary heat exchanger is directed to the windshield anti-icing outlet. When moved to OFF (down), airflow from the anti-icing outlet is shut off and the heater is deactuated. The windshield anti-icing system can also be used for rain removal purposes. Anti-icing air is most efficient in removing rain at low and medium airspeeds and engine speeds above 75% RPM.

(5) *MACHINE GUN CONTROL PANEL*. This panel is part of the aircraft's armament system. It allows selection of the machine guns to be fired (none, two upper guns only, two middle guns only, two lower guns only, all six guns) and indicates their readiness for fire.

(6) *THROTTLE QUADRANT*. The throttle quadrant houses the throttle grip, the speed brake emergency lever (removed on F-86F-35 models), and the wing flap lever.

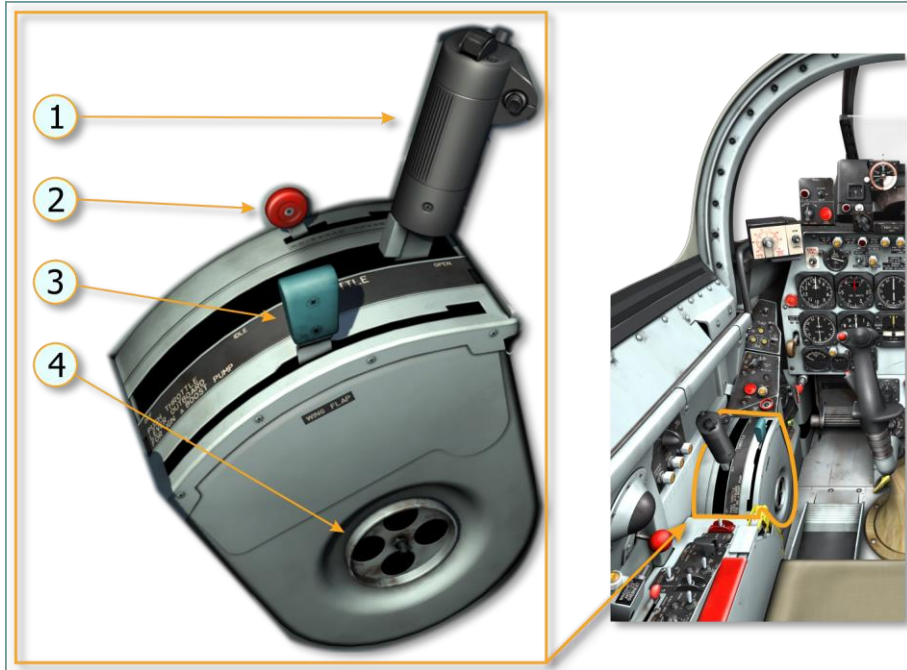

Figure 4.11. Throttle quadrant

- | | |
|---|--|
| 1. Engine throttle | 3. Wing flap lever |
| 2. Speed brake emergency lever
(not installed in F-86F-35) | 4. Throttle friction wheel (not simulated) |

(7) *DROP TANK CONTROL PANEL*. This panel controls the release of external loads (external load can be armament or fuel).

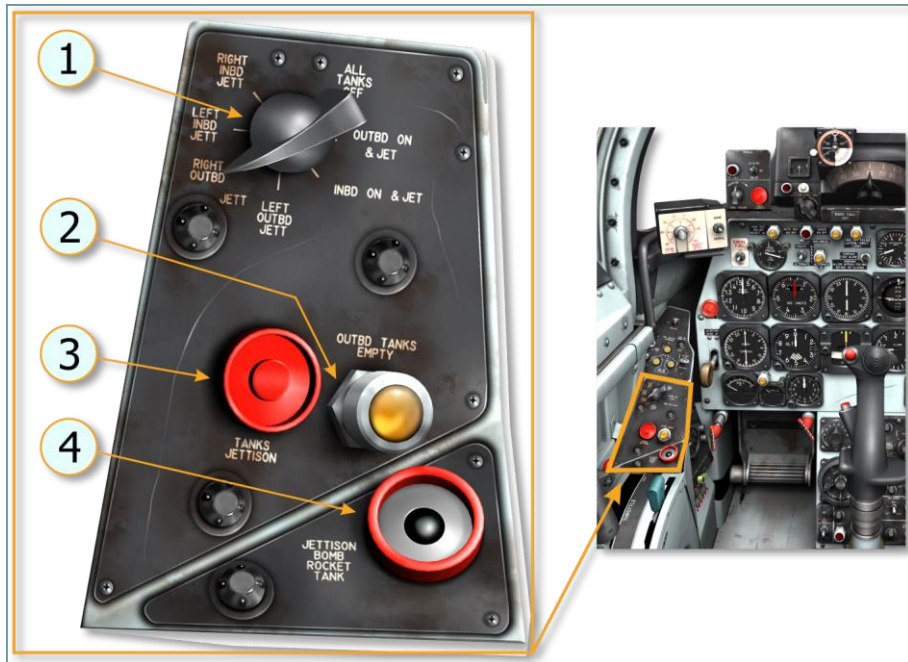

Figure 4.12. Drop tank control panel

- | | |
|---|-------------------------------------|
| 1. Seven-position drop tank selector switch | 3. Drop tank jettison button |
| 2. Outboard drop tank empty indicator light | 4. Bomb-rocket-tank jettison button |

(8) *LEFT FORWARD CONSOLE*. The left forward console contains the landing gear position indicators, anti-ice controls, and the landing/taxi light switch.



Figure 4.13. Left forward console

- | | |
|--|---|
| 1. Engine anti-ice and screen switch | 3. Pitot heater switch |
| 2. Landing gear warning horn cutout button | 4. Landing gear position indication |
| | 5. Landing and taxi light switch |

(9) *EMERGENCY JETTISON HANDLE*. The guarded [emergency jettison handle](#), mounted inboard of the left forward console below the instrument panel, has two definite release positions and permits selective mechanical release of external loads.

Rotating the handle clockwise to a detent stop and then pulling it out as far as possible (about 4 inches) releases only the outboard drop tanks (for finless 200-gallon drop tanks, this action creates an electrical impulse in the tank pylons which fires an explosive charge that forcibly jettisons the tanks).

When the handle is pulled, without rotation, to its full extension of approximately 10 inches, all drop tanks (or all external loads) are released simultaneously.



(10) *OXYGEN REGULATOR PANEL.* The D-2(A) automatic pressure-breathing, diluter-demand oxygen regulator, mounted on the inboard face of the left forward console, controls the oxygen system. For more information, see [5.8](#).

(11) *LEFT AFT CONSOLE.* The left aft console has controls for the [hydraulic system](#), [trim](#), and the [cockpit life support system](#) (Air pressurization and conditioning system).

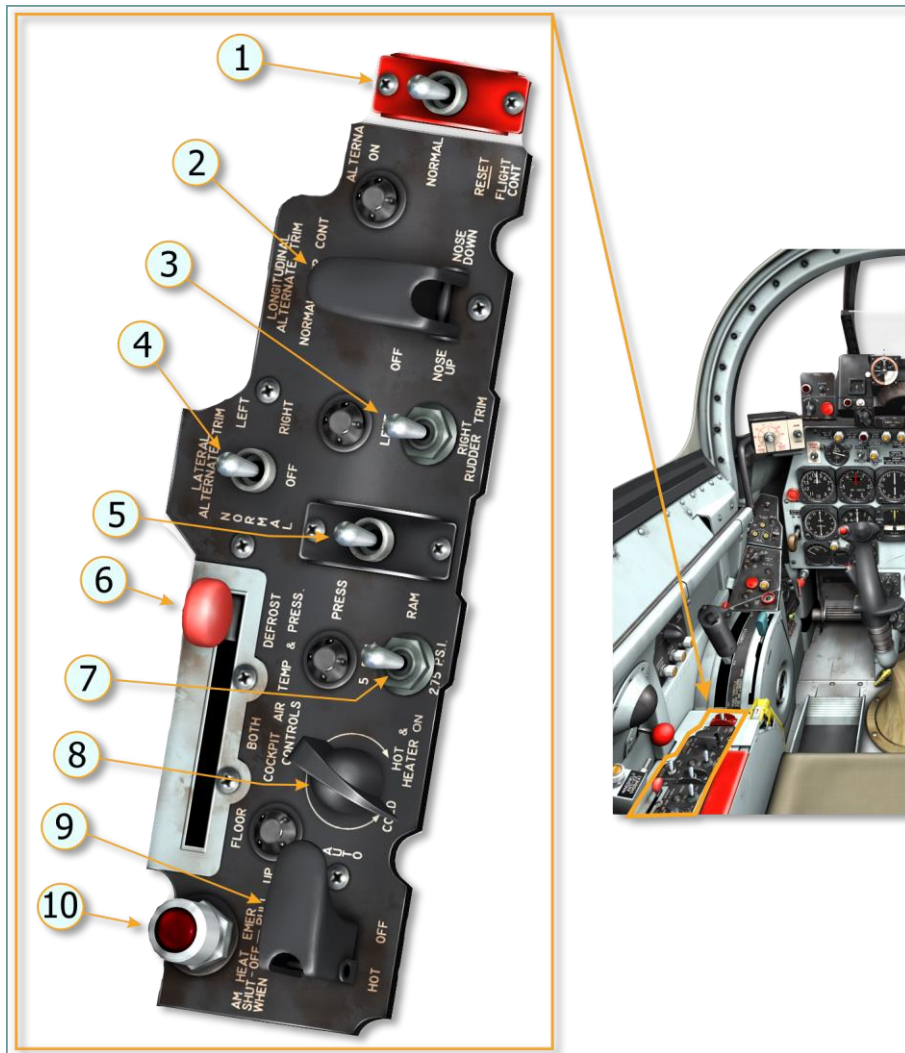

Figure 4.14. Left aft console

- | | |
|---|--|
| 1. Flight control switch | 6. Air outlet selector lever |
| 2. Longitudinal (pitch) alternate trim switch | 7. Cockpit pressure schedule selector switch |
| 3. Rudder trim switch | 8. Cockpit air temperature control rheostat |
| 4. Lateral (roll) alternate trim switch | 9. Cockpit air temperature control switch |
| 5. Cockpit pressure control switch | 10. Ammunition comp. overheat warning light |

(12) *ROCKET INTERVALOMETER*. The rocket intervalometer allows selection of the first unguided rocket to be fired when pressing the bomb-rocket release button on the control stick. [See HERE for details](#).

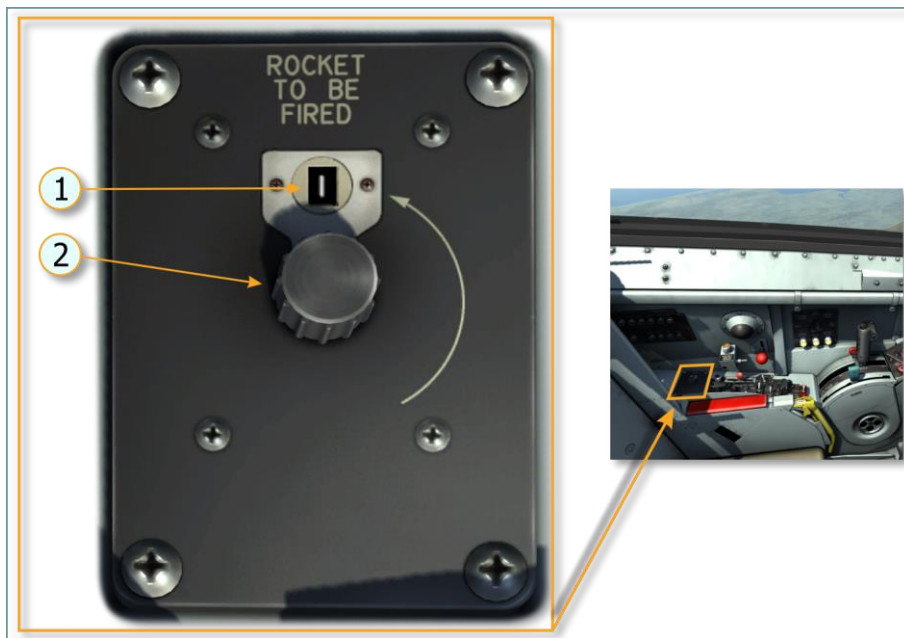

Figure 4.15. Rocket intervalometer

1. Window (indicates the first rocket to be fired, 1-16)
2. Reset knob (sets the rocket to be fired first)

4.4. Cockpit right side

The right side of the cockpit includes the right forward console, lighting controls, radio compass, UHF radio, and IFF control panels.

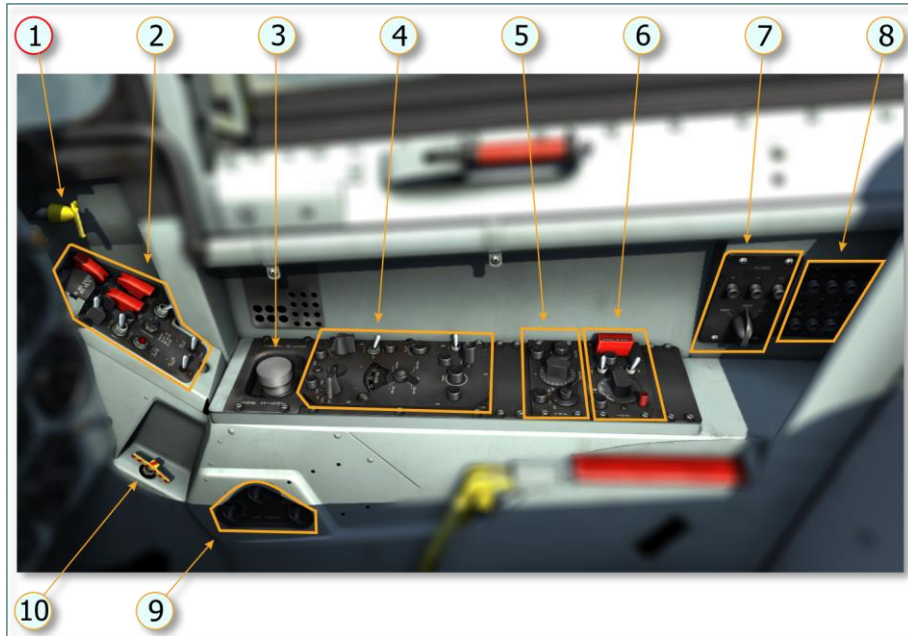

Figure 4.16. Cockpit, right side

- | | |
|---|---|
| 1. Canopy alternate emergency jettison handle | 6. IFF control panel |
| 2. Right forward console | 7. Camera panel (incl. lens switch) |
| 3. Sight ground test plug | 8. Circuit-breaker panel |
| 4. Radio compass (ADF) control panel | 9. Interior light control panel |
| 5. UHF command radio control panel | 10. Emergency override handle (flight control hydraulic system) |

(1) *CANOPY ALTERNATE EMERGENCY JETTISON HANDLE.* The canopy alternate emergency jettison handle, located just to the right of the instrument panel and labelled "ALT CANOPY JET", allows emergency opening of the canopy. It permits the canopy to be jettisoned without arming the seat catapult. When the handle is pulled to its full extended position (approximately two inches), a mechanical linkage withdraws the canopy initiator sear pin, firing a cartridge within the initiator. This actuates the exactor and fires the canopy remover.

Note. This handle is provided as an alternate means of removing the canopy and is designed to be used when it is desired to jettison the canopy without arming the seat catapult. It should not be used in place of the seat handgrip sequence when ejection from the airplane is intended.

(2) *RIGHT FORWARD CONSOLE*. The right forward console has control elements for the fuel control system, generator, engine start, navigation lights, and other equipment, [Figure 4.17](#).

(3) *SIGHT GROUND TEST PLUG* (not simulated). The sight ground test plug (also called the "field test receptacle") for the A-4 gunsight is used to connect the "G-3 sight system analyzer" to perform different pre-flight checks and system tests.

(4) *RADIO COMPASS (ADF) CONTROL PANEL*. (for details, [see here](#)).

(5) *UHF COMMAND RADIO CONTROL PANEL*. (for details, [see here](#))

(6) *IFF (IDENTIFICATION FRIEND-OR-FOE) CONTROL PANEL* (not simulated).

(7) *CAMERA LENS SWITCH* (not simulated).

(8) *CIRCUIT-BREAKER PANEL*.

(9) *INTERIOR LIGHT CONTROL PANEL* (for details, [see here](#)).

(10) *EMERGENCY OVERRIDE HANDLE* (flight control hydraulic system). The emergency [override handle](#), recessed in the inboard face of the right forward console and labelled FLIGHT CONT EMERG, permits the flight control alternate hydraulic system to be engaged should the automatic or selective electrical transfer systems fail. After the handle is unlocked, pulling it out to its fully extended locked position mechanically actuates two solenoid-operated transfer valves which transfer flight control operation to the alternate system. Use of the emergency override handle also connects the alternate system pump directly to the battery bus, bypassing the pressure switches which normally control pump operation. As a result, when the handle is extended, pump operation is continuous regardless of system pressure. The manual emergency change-over may be accomplished regardless of normal or alternate system pressure, and the alternate system will be engaged as long as the handle is in the fully extended position. If the handle is unlocked and returned to its normal position, the alternate system will remain in operation until the flight control switch is held momentarily at RESET and then released to NORMAL.

Caution. Since the alternate system pump will operate continuously as long as the handle is extended, this control should be used only in case of emergency. The life of the pump may be shortened by excessive periods of operation. Also,

drain on the battery in case of generator failure will appreciably lower battery life.

Right Forward Console

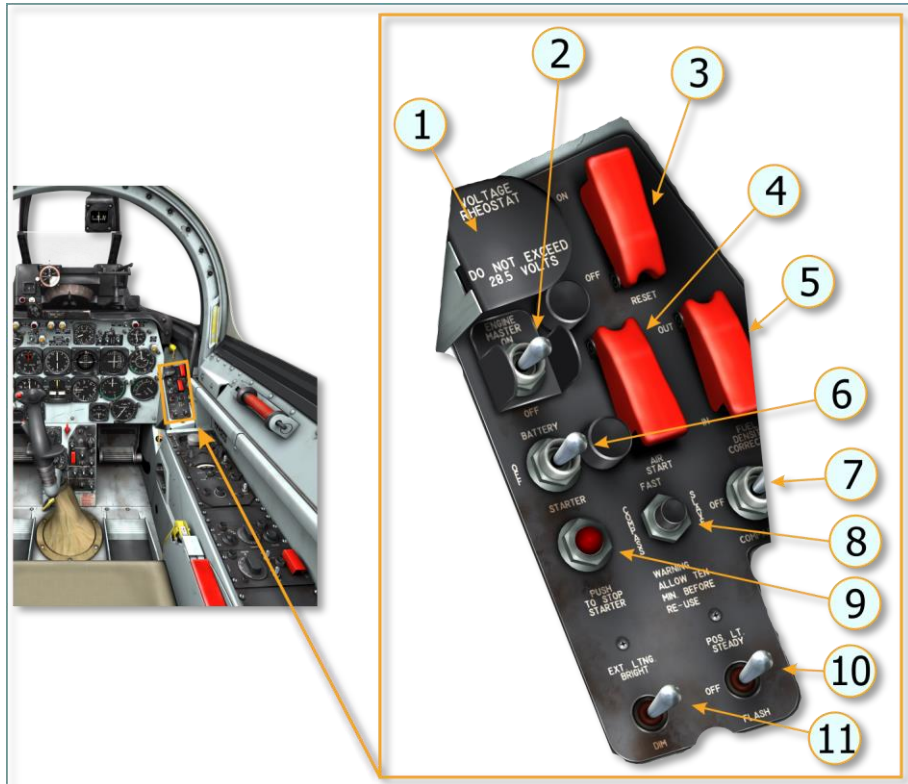

Figure 4.17. Right forward console

1. Generator (DC) voltage regulator rheostat
2. [Engine master switch](#)
3. Generator switch
4. [Emergency \(in-air\) ignition switch](#)
5. [Fuel densitometer selection switch](#)
6. [Battery-starter switch](#)
7. (Magnetic) Compass light switch
8. Magnetic compass fast slaving button
9. [Stop-starter button](#)
10. Position and fuselage light selector switch
11. Exterior lighting [dimmer switch](#)

4.5. Stand-alone controls

CANOPY SWITCH. The canopy switch is used for opening and closing the canopy from inside the cockpit under normal circumstances. See [Figure 3.7](#) for details.



MANUAL PIP CONTROL UNIT. The manual pip control (MPC) unit ([Figure 4.1, 1](#)) is part of the manual pip control system. This system is incorporated into the A-4 gunsight to allow more accurate and safe dive bombing. [See HERE for details.](#)

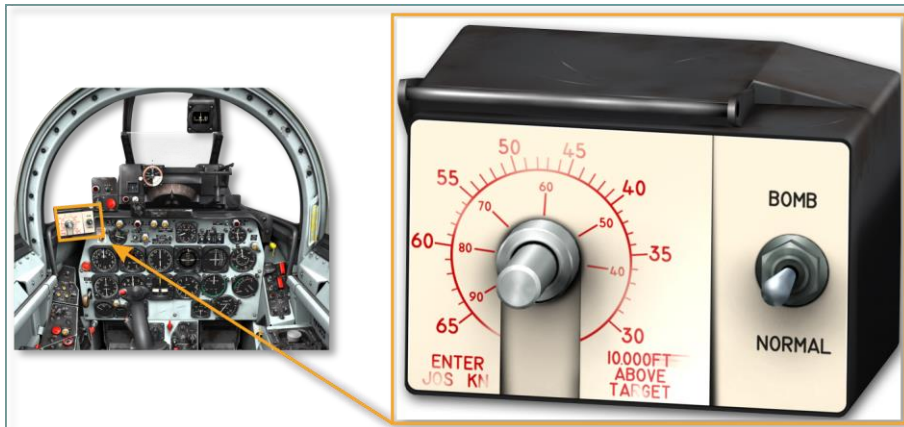

MISSILE CONTROL PANEL. The missile control panel (Figure 4.1, 2) contains four controls for the GAR-8 air-to-air infrared-guided missile system. [See HERE for details.](#)



A-4 SIGHT. The A-4 automatic lead and ballistic computing sight ([Figure 4.1, 3](#)) helps with weapons aiming. [See HERE](#) for details.

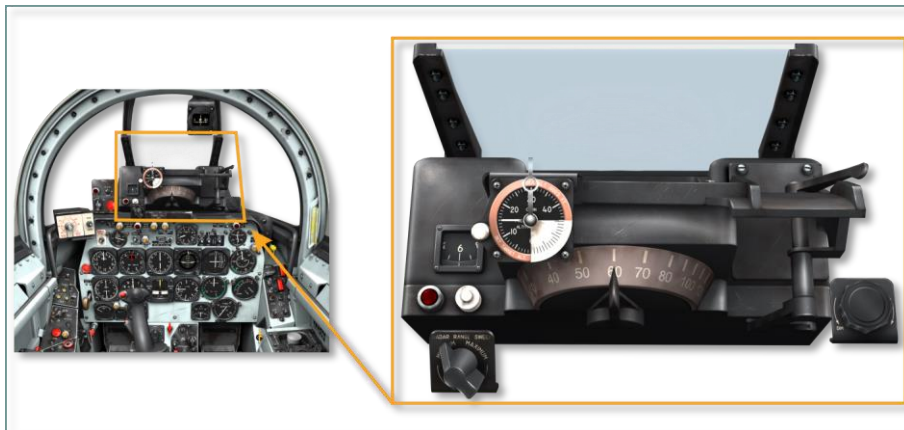

MAGNETIC COMPASS. The conventional magnetic compass ([Figure 4.1, 4](#)) is a back-up device for determining the aircraft's magnetic heading. It is installed to allow navigation in case of instrument or electrical system failure. Illumination of the magnetic compass is controlled by the compass light switch on the right forward console while the brightness is controlled by the console lighting rheostat.

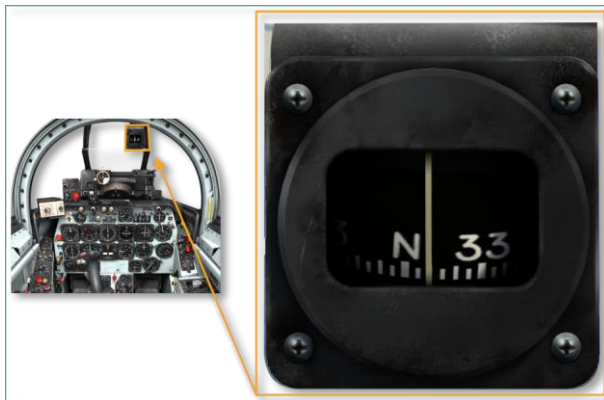

CANOPY MANUAL OPERATING HANDLE (not simulated). The canopy manual operating handle ([Figure 3.10](#), [Figure 4.1](#), 7) is used for pulling the canopy open on the ground in case it cannot be opened electrically, or in flight only if the canopy must be declutched for removal.

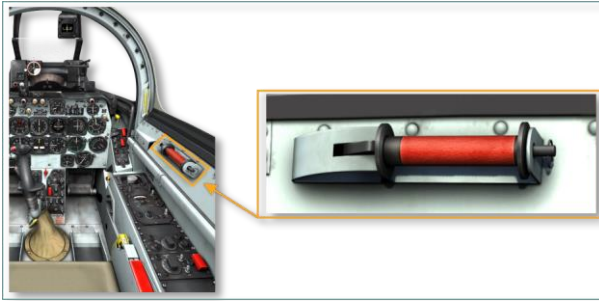

CENTER PEDESTAL (ARMAMENT PANEL). The armament panel, located on the center pedestal ([Figure 4.1, 9](#)), houses various controls for sight functions and armament modes. [See HERE for details.](#)



EMERGENCY CONTROL PANEL. The emergency control panel ([Figure 4.1, 9a](#)), located on the lower center pedestal, below the armament panel, contains the canopy declutch handle (yellow, [see HERE for details](#)) and the landing gear [emergency release handle](#) (red).

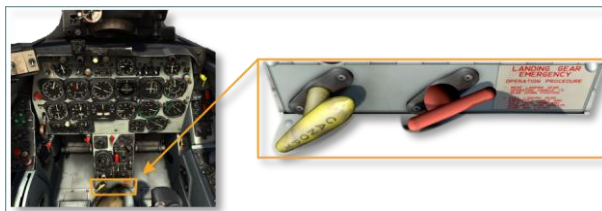

SPECIAL STORE EMERGENCY JETTISON HANDLE (not simulated). To jettison the "special" store in the event of electrical jettison system failure, a mechanical release handle is provided below the instrument panel, on the upper left side of the center pedestal.

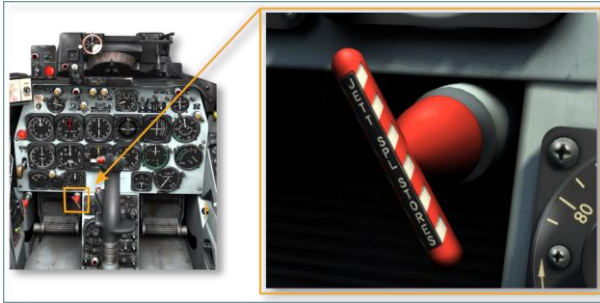

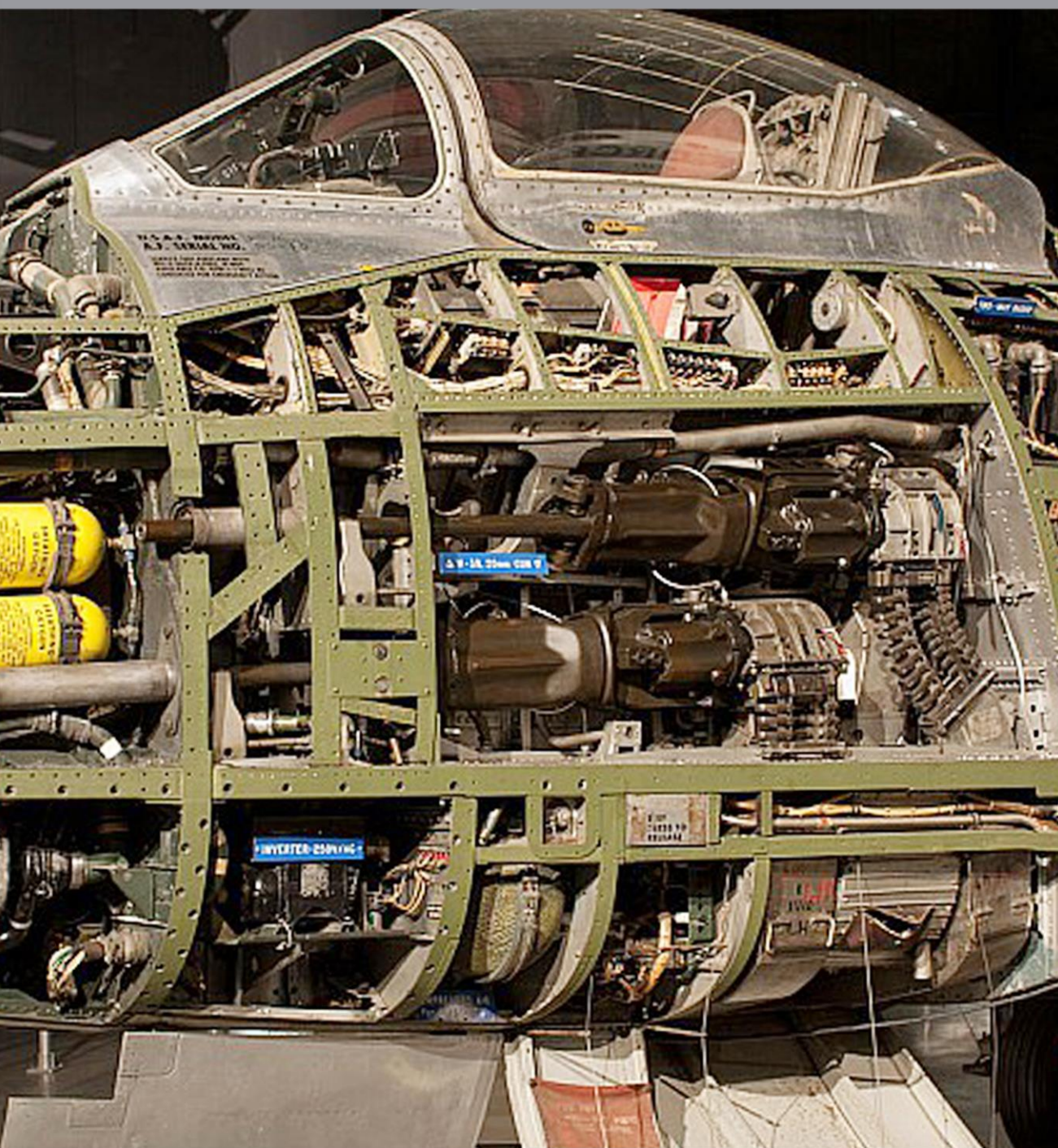

5

SYSTEMS

5. SYSTEMS

5.1. Flight control system

Desirable handling qualities are maintained throughout the speed range of the airplane by the use of a flight control system made up of several components including:

- the ailerons in the roll channel (Figure 3.2);
- the controllable horizontal tail in the pitch channel (Figure 3.6);
- the boost hydraulic system;
- the control stick (Figure 4.3);
- the artificial-feel system;
- the rudder pedals;
- the rudder in the directional channel (Figure 3.5);
- the trimming mechanism in the directional (heading) control channel;

Ailerons

The ailerons which lie on the outer halves of the wings (Figure 3.2) provide roll control and are actuated hydraulically.

Boost hydraulic system

The horizontal tail and the ailerons are actuated by a constant-pressure type hydraulic system. Movement of the control stick mechanically positions hydraulic control valves which consequently direct pressure to the actuating cylinder of the respective controls surface. The irreversible characteristic of the hydraulic control system holds the control surfaces against any forces which do not originate from control stick action, and prevents these forces from being transmitted back to the stick. Thus, aerodynamic loads of any kind cannot reach the pilot through the stick. Because of this irreversibility, an artificial-feel system is built into the aileron and horizontal tail control systems to provide normal feel.

Control stick

The conventional B-8A control stick is used for deflecting the aerodynamic control surfaces: the horizontal tail (when the stick is moved forward and backward) and the ailerons (when the stick is moved left or right). The

aerodynamic surfaces, when deflected by the stick, create force moments and thus change position of the airplane in the airflow.

The control stick is mechanically connected by push-pull rods and cable systems to hydraulic control valves at the control surfaces. Movement of the stick positions the control valves so that pressure from the flight control hydraulic system is directed to the control surface actuating cylinders. Thus, a movement of the control stick repositions the hydraulic valves in such a way that the struts of the hydraulic system components take the position proportional to the position of the control stick.

Despite the lack of feedback from the control surfaces to the control stick due to the nature of the hydraulic actuators, the pilot still feels pressure on the control stick through a spring-loaded artificial-feel system in the roll and pitch channels of the control system.

Artificial-feel system

No stick feel from natural forces is present in the F-86F since air loads can not be transmitted to the stick through the aileron and horizontal tail hydraulic control system. To transmit the desired natural stick feel to the pilot under all flight conditions and impose neutralizing forces on the stick, the addition of an artificial-feel system is necessary.

Spring bungees are connected to the pitch and roll channels of the control system and simulate control surface air loads. They apply loads to the stick proportional to the degree of stick deflection away from the trim position. The additional longitudinal stick forces normally resulting from G-loads are provided through a bob weight in the tailplane and elevator linkage which acts in conjunction with leaf springs on each side of the tailplane selector valve lever. Aileron air loads are simulated through spring-loaded struts which apply forces to the stick in proportion to the degree of stick deflection from neutral.

To provide lateral and longitudinal trim, the artificial-feel bungees are repositioned to change the neutral (no-load) position of the stick to a different load-free spot.

The main elements of the artificial-feel system are a spring, a movable stop, and a mechanism that changes the stiffness of the load spring. This mechanism is designed to change the stiffness of the load spring in relation to the airspeed (the actuating mechanism receives the airspeed signal and changes the stiffness of the load spring proportionately: the higher the airspeed, the stiffer

the spring) to protect the pilot from an inadvertent increase of G-load at high airspeeds.

Normal trim switch

Normal control for longitudinal (pitch) and lateral (roll) trim is provided by the normal trim switch, a five-position, thumb-actuated switch on top of the control stick grip. Its five positions are: forward [RCtrl + ;], backward [RCtrl + .], left [RCtrl + ,], right [RCtrl + /] and the spring-loaded center/neutral OFF position. When released, it automatically returns to the OFF position and trim action stops.



Trimming is accomplished by operating the trim switch to remove or reduce stick loads after the stick is positioned to maintain the desired flight attitude. Holding the normal trim switch to either side energizes the electric lateral trim actuator. Holding the switch forward or aft energizes the longitudinal trim actuator. The trim actuators, when energized, reposition the artificial feel bungees. The bungees, in turn, apply the necessary force to establish a new neutral (no-load) position of the stick, eliminating or reducing control stick loads. The normal trim circuit is powered by the primary bus.

Caution. For the normal trim switch to be effective for lateral trim, both alternate trim switches must be at NORMAL. For the normal trim switch to be operable for longitudinal trim only, the longitudinal alternate trim switch must be at NORMAL.

The trimming mechanism operates by moving the load spring movable stop via the electric engine. The load on the spring becomes less as the stop moves towards zero force (as long as the button is pressed and held down, the stop keeps moving). When the normal trim switch is pressed in a direction away from zero force, the load on the spring increases.

The normal trim switch can be controlled with the keyboard (pitch – [RCtrl + ;], [RCtrl + .]; roll – [RCtrl + ,], [RCtrl + /]) and is also mouse-clickable.

The aircraft also has two alternate switches for trimming in the lateral (1) and longitudinal (2) channels. These switches are used in case of normal trim switch failure.

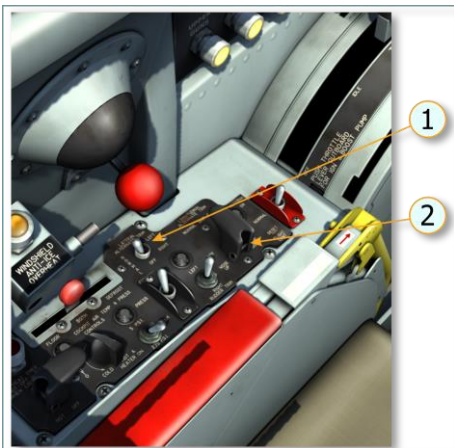

Back-up trim switches:

1. Lateral alternate trim switch
2. Longitudinal alternate trim switch

Lateral alternate trim switch

The four-position lateral alternate trim switch, located on the left aft console, controls an alternate primary-bus-powered circuit for obtaining lateral (roll) trim. The switch is ordinarily kept at NORMAL, which permits use of the normal trim switch on the stick grip. When held at either LEFT or RIGHT, the normal trim circuit is disconnected. The lateral trim actuator is then energized by the alternate trim circuit to reposition the stick. Use of the alternate switch accomplishes lateral trim in the same manner and at the same speed as when the normal trim switch is used. Operating time of the aileron trim tabs from full up to full down position is approximately 10-11 seconds.

The switch is spring-loaded from the LEFT and RIGHT positions to OFF. The normal and the alternate lateral trim circuits are inoperative when the lateral alternate trim switch is OFF.

Caution. The lateral alternate trim switch must be in the NORMAL position for the normal trim switch to be operable for lateral trim.



Longitudinal alternate trim switch

The guarded four-position longitudinal alternate trim switch, located on the left aft console, provides an alternate primary-bus-powered circuit for longitudinal (pitch) trim. The switch is usually kept in the guarded NORMAL GRIP CONT position which allows use of the normal trim switch on the stick grip for trim control. Holding the switch at NOSE UP or NOSE DOWN disconnects the normal trim circuits and energizes the longitudinal trim actuator, through the alternate longitudinal trim circuit, to reposition the stick. Operation of this switch accomplishes longitudinal trim in the same manner and at the same speed as when the normal trim switch is used. Operating time of the elevator trim tabs from full up to full down position is approximately 15 seconds.

The switch is spring-loaded from the NOSE UP and NOSE DOWN positions to OFF. When the switch is OFF, both of the normal trim circuits, as well as the longitudinal alternate trim circuit, are inoperative.

Caution. The longitudinal alternate trim switch must be kept in the NORMAL GRIP CONT position for the normal trim switch on the stick grip to be operable for lateral and longitudinal trim.

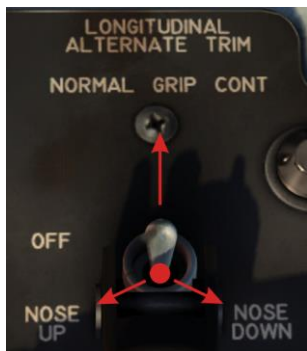

Take-off trim position indicator light

The amber [take-off trim position](#) indicator light (see [4.2.8](#)) illuminates briefly when the trimmer surface being moved (either by the normal trim switch for pitch and roll or by the rudder trim switch for yaw) enters its takeoff position. The light does not illuminate when trimming via the alternate trim switches.



Figure 5.1. Take-off trim position indicator light

Controllable horizontal tail

The elevators and horizontal stabilizer are controlled and operated together, as one unit, known as the controllable horizontal tail ([Figure 3.6](#)) or the "all-flying tail" to control pitch. This type of control surface, incorporated in the F-86E and subsequent models, reduces high-speed instability considerably and eliminates many of the undesirable compressibility effects that were characteristic of the F-86A such as loss of control effectiveness at high Mach numbers.

The horizontal stabilizer is pivoted around its rear spar so that the leading edge is moved eight degrees up or down by normal control stick action. Pulling the control stick back causes the stabilizer to deflect its leading edge down (max. -10° from the 0° fuselage reference line). Pushing the control stick forward causes the stabilizer to deflect its leading edge up (max. $+6^\circ$ from the 0° fuselage reference line). The elevator is connected to the stabilizer by mechanical linkage and moves in a direct relationship to stabilizer movement, with the elevator travel being slightly greater than stabilizer travel. When the pilot needs to change pitch, the stabilizer moves in conjunction with the elevator, i.e. the whole tailplane assembly acts as one movable control surface.

This joint deflection of the stabilizer and the elevator effectively creates a larger elevator surface and results in a greater angle of attack, creating better control at all speeds. This increase of control effectiveness allows the aircraft to maintain good pitch control efficiency even at speeds close to the speed of sound ($M=0.9$ and greater) and allows easier recovery from a sonic dive with much less danger of structural damage or catastrophic failure.

Rudder pedals

The rudder is controlled by a cable system from conventional hanging-type rudder pedals. The pedals are adjustable, fore and aft, by means of a lever on the outboard side of each pedal assembly. Exact alignment of the pedals during adjustment is facilitated by position indicators that are adjacent to the adjustment lever on each pedal. Each indicator consists of a numbered dial; when the visible dial numbers on each pedal correspond, the pedals are adjusted evenly. During taxi on the ground, toe action on the upper part of the rudder pedals operates the wheel brakes [\[W\]](#).

The pedals are connected to the rudder by mechanical linkage (a system of struts and cranks). The forces on the pedals are transmitted from the rudder by an inverse scheme. However, in the pitch control channel there is an electric trimming mechanism that deflects the rudder by deflecting a trim plate which essentially relieves the force on the pedals.

Rudder trim switch

The electrically (primary bus) actuated rudder trim tab is controlled by the three-position rudder trim switch ([Figure 5.2](#)), located on the left aft console. Its three positions are LEFT (up), OFF (center), and RIGHT (down). The switch is held at LEFT or RIGHT for corresponding rudder trim and is spring-loaded from these positions to the center OFF position.



The rudder trim switch can be controlled with the keyboard ([\[L\]Ctrl + \[L\]Alt + \[A\]](#), [\[L\]Ctrl + \[L\]Alt + \[S\]](#)) and is also mouse-clickable.

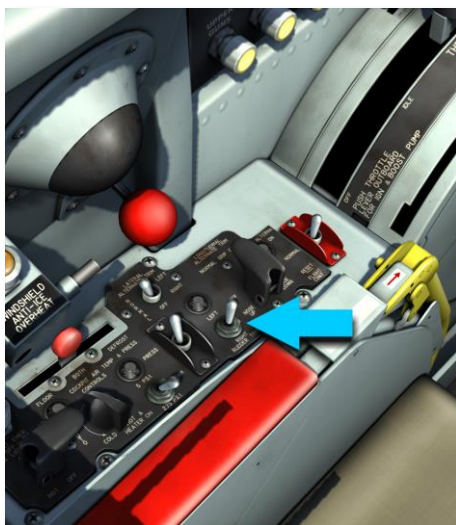
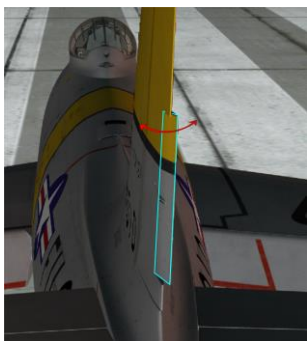

Figure 5.2. Location of the rudder trim switch



Rudder trim tab travel time from one extreme position to the other is approx. 28-30 seconds.

Note. The electric trimming mechanism is used in case of lateral asymmetry, i.e. after failure to release a bomb (or a drop tank) or after loss of aerodynamic symmetry by the wing due to damage.

5.2. Power supply system

5.2.1. General description

The aircraft is equipped with both DC and AC electrical systems.

DIRECT-CURRENT (DC) POWER SUPPLIES:

- 24 volt power supply from the battery which serves as a standby DC power supply;
- 28.5 volt power supply from the generator which is the main DC power supply mechanically connected with the engine rotor.

For engine start on the ground, a ground DC power source is connected to the aircraft.

ALTERNATING-CURRENT (AC) POWER SUPPLIES:

Alternating current (AC) is provided by a single-phase (115 V, 400 Hz) and two three-phase (115 V, 400 Hz) inverters.

For operation of systems except for power sources, the cockpit has circuit breakers, push-buttons, switches, indicators, and warning lights (see below).

Cockpit objects connected with electrical system:

	<p>1. Left circuit breaker panel (in the simulation, all circuit breakers are turned on by default).</p>
	<p>2. DC voltmeter. Indicates the generator output voltage.</p>

		<p>3. Power supply load indicator. Indicates consumed power in percentage of generator power.</p>
		<p>4. Generator failure warning light.</p>
		<p>5. Main three-phase inverter failure warning light.</p>
		<p>6. Both three-phase inverters failure warning light.</p>
		<p>7. Single-phase inverter failure warning light.</p>

		<p>8. Battery switch.</p>
		<p>9. Generator switch. Always on by default and covered with a safety cap. Has three positions: ON – OFF – RESET.</p>
		<p>10. Voltage rheostat (not used in the game).</p>
		<p>11. Right panel of circuit breaker (for the gamer not necessary to use, all circuit breakers are on by default).</p>

Scheme of aircraft power supply

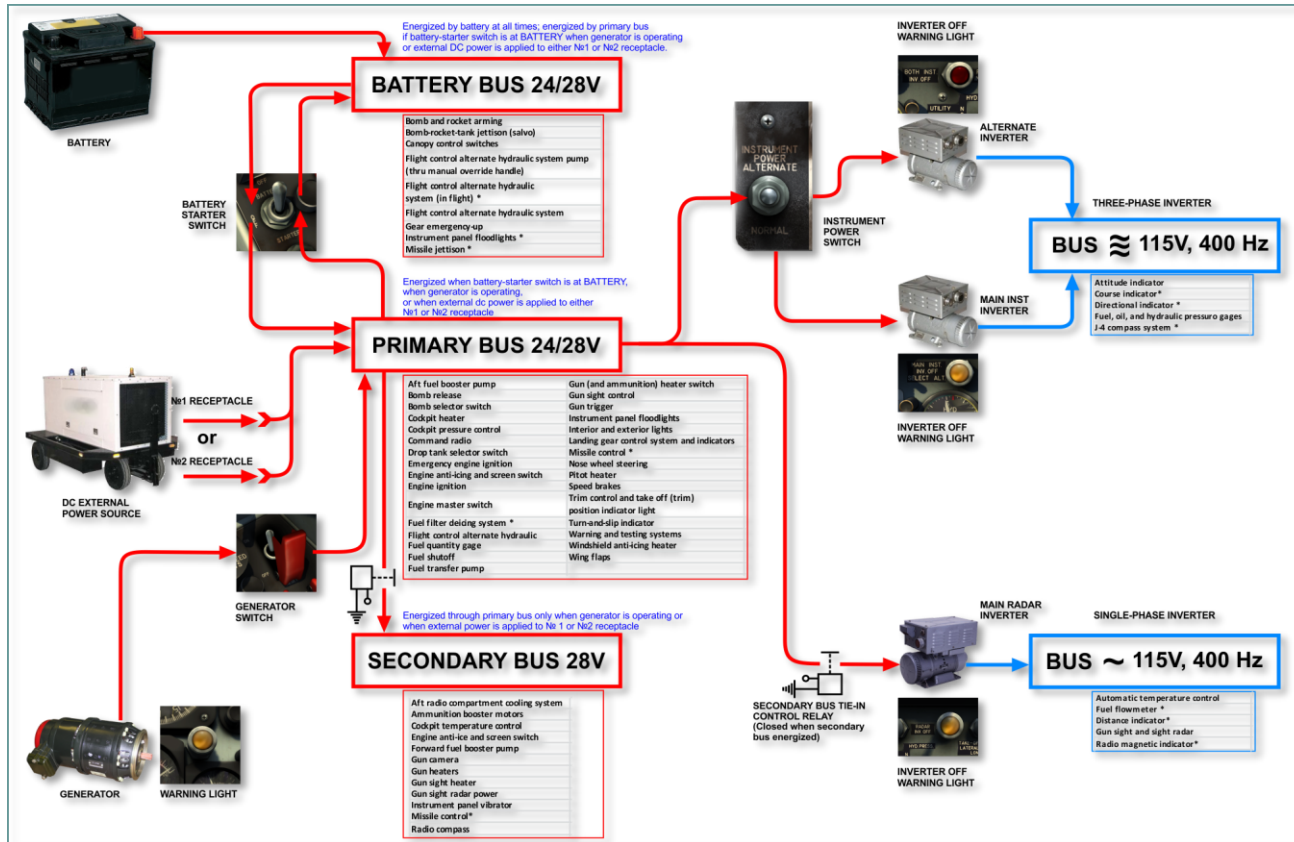

Figure 5.3. F-86F-35 power supply scheme

DC power supply system

DC power is supplied via three buses: the battery bus, the primary bus, and the secondary bus.

The *BATTERY BUS* is powered directly from the battery. It is always on when the battery capacity is sufficient, irrespective of the position of the BATTERY – OFF switch. The battery bus can receive power from the generator or from an external power source only if the BATTERY – OFF switch is in the BATTERY position.

Power consumers:

BATTERY BUS
Bomb and rocket arming
Bomb-rocket-tank jettison (salvo)
Canopy control switches
Flight control alternate hydraulic system pump (thru manual override handle)
Flight control alternate hydraulic system (in flight) *
Flight control alternate hydraulic system
Gear emergency-up
Instrument panel floodlights *
Missile jettison *

THE PRIMARY BUS is connected directly to the generator terminals. This bus can be connected to the battery only if the BATTERY–OFF switch is in the BATTERY position.

Power consumers:

PRIMARY BUS
Aft fuel booster pump
Bomb release
Bomb selector switch
Cockpit heater
Cockpit pressure control
Command radio
Drop tank selector switch
Emergency engine ignition
Engine anti-icing and screen switch
Engine ignition
Engine master switch
Fuel filter deicing system *

Flight control alternate hydraulic system (on ground) *
Fuel quantity gauge
Fuel shutoff
Fuel transfer pump
Gun (and ammunition) heater switch

THE SECONDARY BUS receives power from the primary bus but only if the generator is on or if there is an external power supply from Port 1. or Port 2.

Power consumers:

SECONDARY BUS
Aft radio compartment cooling system
Ammunition booster motors
Cockpit temperature control
Engine anti-ice and screen switch
Forward fuel booster pump
Gun camera
Gun heaters
Gun sight heater
Gun sight radar power
Instrument panel vibrator
Missile control
Radio compass

This configuration of power supplies allows an easy disconnection of secondary class consumers in case of generator failure.

In the BATTERY position, the battery is used as a standby power source. The battery capacity is 34 Ah.

The generator capacity is more than 11kW (allowable current is 400A).

AC power supply system

The AC power supply system includes:

- single-phase 115V 400Hz current and bus (powered by a single-phase inverter);
- three-phase 115V 400Hz current and bus (powered by a three-phase inverter).
- an additional standby three-phase inverter in the three-phase circuit which is engaged in case of failure of the main one (but only by manual switching);
- two three-phase inverters connected to the primary bus (main consumers are the fuel indicator, the oil pressure indicator, and the hydraulic system pressure indicator).

Three-phase inverters supply all the gyroscopic equipment, the fuel flow meter, and pressure indicators (fuel, oil, and hydraulic systems).

Ground power connection

Two ground power receptacles are located on the left side of the fuselage slightly behind and above the wing trailing edge.

On the F-86F-35, when a ground power source is connected to Port 1 or Port 2, the power is supplied to both buses (and to the battery if the switch is in the BATTERY position).

Circuit breakers

Most electrical circuits are protected from overload by double-contact push-pull type circuit breakers and automatic switches. The circuit breaker panels are located on the left and right sides in the cockpit (near the pilot seat) and allow replacement of the circuit breakers in flight (no need for that in the game). By default, they are always on so there is no need for the player to turn them on during pre-flight preparation.

Most AC circuits are protected by circuit breakers that cannot be replaced in flight.

5.2.2. Failures of power supply system components

Generator failure



Indicated by an amber light. The light illuminates in case of generator failure or when the GENERATOR switch is in the OFF or RESET position.

The generator may fail due to mechanical damage (for example, by a fragment or a projectile). It automatically disconnects if the input voltage exceeds 31 volts. In case of an over-voltage, you can try to recover the generator by moving the switch to RESET and then back to ON.

C a u t i o n : Illumination of the GENERATOR FAILURE warning light means all the equipment supplied from the secondary bus is in a failure condition. All consumers of the primary bus are redirected to the battery. Therefore, in order to save battery power, all equipment that does not affect flight safety must be turned off.

The consumers listed in the table below are disconnected.

Aft radio compartment cooling system
Ammunition booster motors
Cockpit temperature control
Engine anti-ice and screen switch
Forward fuel booster pump
Gun camera
Gun heaters
Gun sight heater
Gun sight radar power
Instrument panel vibrator
Missile control
Radio compass

When the generator fails, the SECONDARY BUS TIE-IN CONTROL RELAY

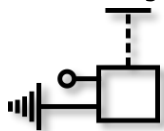

is actuated (see [Figure 5.3](#)) which disconnects the consumers that were connected to the 115V bus (see single-phase inverter failure).

The battery power is sufficient for a 7 to 10 minute flight.

Single-phase inverter failure



Indicated by an amber light  on the instrument panel.

In case of a single-phase inverter failure, the whole single-phase 115V 400Hz circuit is de-energized. All the consumers of this circuit go off (see the table below).

Automatic temperature control
Fuel flowmeter
Distance indicator
Gun sight and sight radar
Radio magnetic indicator

Single three-phase inverter failure



Indicated by an amber light on the instrument panel. In case of a single three-phase inverter failure, the power must be switched to a stand-by inverter by turning a switch on the Center pedestal:

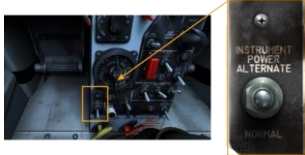

. After switching to the stand-by inverter, the power supply of all consumers of the three-phase 115V 400Hz AC bus is restored.

Failure of both three-phase inverters



Indicated by a red light on the instrumental panel.

In case of failure of both three-phase inverters, the whole three-phase 115V 400Hz AC circuit is de-energized. All consumers of this circuit go off (see table below).

Attitude indicator
Course indicator
Directional indicator
Fuel, oil, and hydraulic pressure gauges
J-4 compass system

5.3. Fuel system

The purpose of the fuel system is to store onboard fuel, provide continuous fuel supply to the fuel control system, and ensure fulfillment of the required fuel management schedule.

5.3.1. General scheme and description

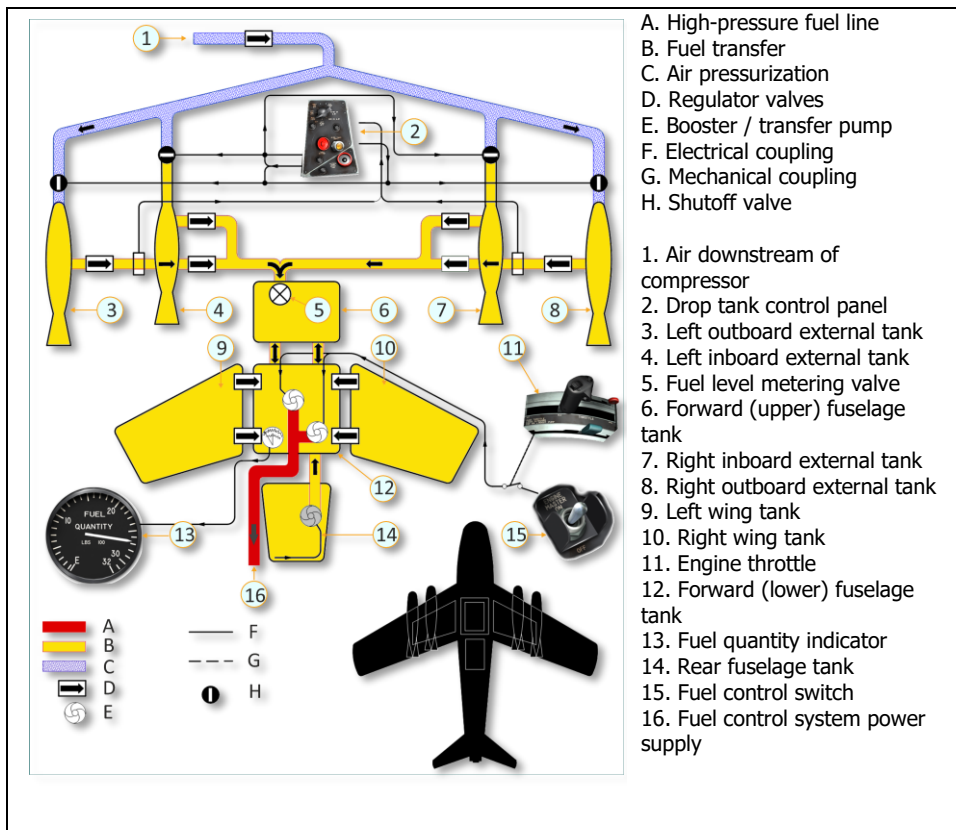

Figure 5.4. Scheme of aircraft fuel system

The onboard fuel is stored in four tanks – two (forward and rear) in the fuselage and one inside each half-wing.

To increase the onboard fuel reserve, external tanks can be installed – two under each half-wing.



Figure 5.5. The aircraft with external fuel tanks

The inboard pylons can take 450 litre (120 gallon) tanks. The outboard pylons can take 760 litre (200 gallon) tanks.







The forward fuselage tank consists of two sections – upper and lower. The lower section serves as a supply. All the other fuel tanks including the external tanks are connected to this supply tank. It has two electrical booster pumps that start working as soon as the ENGINE MASTER is on and the engine throttle is moved from OFF to IDLE. At normal operation, the fuel flows by gravity to the supply tank. In the rear fuselage, there is an additional fuel tank that is automatically engaged when the fuel level in the supply tank becomes low (at approximately 200 litres (56 gallons)). Reverse fuel flow is prevented by check valves.

The fuel system has one *TRANSFER* pump (in the rear tank) required for refilling the supply tank and two *BOOSTER* pumps in the supply tank itself required for creating additional pressure upstream of the fuel control system pump.

The transfer pump and the rear booster pump are connected to the primary line whereas the front booster pump is connected to the secondary line. However, in case all pumps fail, the fuel system will continue to function, i.e. the engine's automatic pump will automatically engage creating additional pressure which will force fuel from the rear tank to flow into the front tank on its own. As a result, changes to the airplane's balance may be noticeable as fuel is consumed.

5.3.2. Cockpit objects related to fuel system

	<p>1. Engine throttle in aftmost (OFF) position for mechanical shutoff of fuel line from tanks to the engine</p>
	<p>2. Drop tank control panel</p>
	<p>3. Drop tank control panel. 7-position selector switch (wafer switch) for selection of active external tanks</p>
	<p>4. Drop tank control panel. Tanks jettison button.</p>

	<p>5. Drop tank control panel. Outboard tanks empty warning light</p>
	<p>6. Drop tank control panel. All external load jettison button</p>
 	<p>7. Fuel quantity indicator. Maximum value (inner tank) – 2879 lbs</p>
 	<p>8. Fuel flow meter</p>



FUEL QUANTITY INDICATOR is located on the instrument panel and shows the overall fuel quantity in the internal tanks. A special feature of this device is that it is calibrated for thousands of pounds even though measurement of fuel in the fuel tanks is based on fuel volume. Although density and thermal expansion are compensated for automatically, the conversion from volume to weight leaves room for imprecision in the fuel reading.

Note. The fuel quantity indicator only starts showing a reading change after all fuel in the external tanks is depleted and fuel in the internal tanks starts to be consumed.

FUEL FLOW METER is located on the instrument panel and shows the fuel flow rate in the supply line, expressed in pounds per hour. The readings of the fuel flow meter are not precise (they depend on temperature, density, and chemical composition of the fuel) and allow the pilot to estimate the fuel flow rate. The device is supplied by three-phase AC current.

5.3.3. Fuel management schedule

The first tanks to be depleted are the external tanks. To ensure fuel transfer from these tanks, they are pressurized by air downstream of the compressor (see [Figure 5.4](#)). Then approximately 80 litres (20 gallons) of fuel from the upper part of the forward tank are used (gravity feeding the lower part of the tank). Then a transfer pump in the rear tank turns on and starts pumping fuel through the lower section of the forward tank into the upper section. This cycle repeats until the fuel in the rear tank starts swaying. Then the fuel from the internal wing tanks starts gravity feeding the lower part of the forward tank. This fuel management schedule allows the forward center of gravity to be maintained.

The automatic fuel depletion sequence is ensured by the difference of pressure in the tanks and the operation of the transfer pump in the rear fuselage tank. In case of transfer pump failure, the force of the pumps in the forward tank is

sufficient for creating fuel flow from all internal tanks to the supply tank resulting in stable operation of the engine.

5.3.4. Fuel tank usage control

The fuel tank usage and jettison is controlled by the drop tank control panel ([Figure 4.12](#)) on the left slope panel in the cockpit. Both usage and jettison of external fuel tanks are controlled by putting the wafer switch in the respective



position.

Setting the switch to the OUTBD ON & JET position pressurizes the external outboard tanks by opening the shutoff solenoid valves and allowing compressed air from behind the compressor to flow to the external fuel tanks. Similarly, setting the switch to the INBD ON & JET position pressurizes the external inboard tanks. To keep the center of gravity in the right position and to ensure normal roll control, it is recommended to use the outboard external tanks first and then the inboard external tanks.

Even after fuel consumption from the internal tanks begins, the wafer switch must be kept in the INBD ON & JET position. This guarantees complete fuel depletion from the inboard external tanks (there is no indication of fuel depletion for these tanks unlike for the outboard external tanks).

When the switch is in the ALL TANKS OFF position, the external tanks are no longer pressurized and fuel is not supplied from them.

For the jettison of inboard tanks, the inboard pylon locks are opened by an electrical signal. For the jettison of outboard tanks, the electrical signal opens the locks and, additionally, activates an explosive mechanism that pushes the tanks away from the aircraft.

To jettison the tanks, it is necessary to take the following steps:

- make sure the tanks to be jettisoned do not contain any more fuel: for outboard tanks, this is indicated by an amber warning light; for inboard tanks, this is indicated by the start of fuel consumption from the

fuselage tanks, i.e. when the fuel indicator starts to show less than 2,880 pounds;

- set the wafer switch to the position corresponding to the tank(s) selected for jettison:

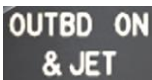

for the jettison of outboard tanks;



for the jettison of inboard tanks;

- press the TANKS JETTISON button.

A specific tank is jettisoned by setting the wafer switch to the respective position (in the above example it is the right outboard tank).

Note. It is also possible to jettison full or half-depleted tanks if necessary. The switch in the tank jettison position powers the jettison circuits if there is power supply on the primary bus.

5.3.5. Amount of fuel uplift

The amount of fuel per tank is given in Table 5.1.

Table 5.1

Tank	Number of tanks	Effective (usable) fuel (for each tank)				Full fuel (for each tank)			
		pounds	kg	gallons	liters	pounds	kg	gallons	liters
Forward fuselage	1	1,274	580	196	740	1,306	592	201	760
Rear fuselage	1	682	310	105	400	689	312	106	402
Inside wing	2	435	197	67	250	442	200	68	257
External inboard	2	780	350	120	450	780	350	120	450
External outboard	2	1,300	590	200	760	1,306	592	201	760

Notes.

1. Total effective (usable) fuel without external fuel tanks: 2,827 pounds/435 gallons.
2. Total effective (usable) fuel with two external 120 gallon fuel tanks: 4,287 pounds/675 gallons.

3. Total effective (usable) fuel with two external 120 gallon and two external 200 gallon fuel tanks: 6,987 pounds/1,075 gallons.

5.4. Hydraulic system

5.4.1. General description

The aircraft has three independent hydraulic systems with a constant pressure: the normal booster hydraulic system, the alternate booster hydraulic system, and the utility hydraulic system.

The purpose of both booster systems, as indicated by their names, is to relieve the loads on the control stick in the pitch and roll control channels.

The utility hydraulic system is fully independent of the two booster systems and supplies the following aircraft systems:

- Landing gear extension and retraction system;
- Nosewheel steering system;
- Wheel brakes;
- Speed brakes (extension and retraction).

In addition, the utility hydraulic system has a hydraulic accumulator for the emergency extension of the nose landing gear.

The pressure in all three of the systems is displayed on one common indicator located in the upper left corner of the instrument panel. The pressure indicator has a switch for choosing between the UTILITY, NORMAL, and ALTERNATE hydraulic systems.

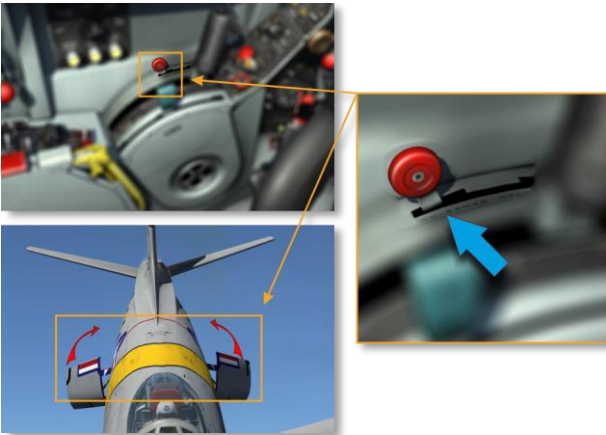



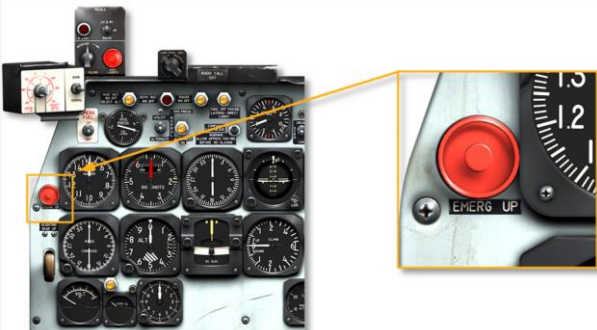

Figure 5.6. Hydraulic system indication and controls

The pressure indicator is supplied by a three-phase (36V/400Hz) converter bus connected to the primary bus.

5.4.2. Cockpit objects related to hydraulic systems

		<p>1. FLIGHT CONT switch of the booster system: for activation of the alternate booster HS, the switch must be moved to ALTERNATE ON; for activation of the normal booster HS, the switch must be moved to RESET for a short time and then to NORMAL</p>
--	--	--

 <p>The image block contains three sub-images. The top-left image shows a cockpit view of the engine throttle quadrant with a yellow box highlighting a switch. The bottom-left image shows a top-down view of the aircraft with yellow boxes on the wings and red arrows indicating the deployment of speed brakes. The right image is a close-up of the throttle quadrant with a red arrow pointing to a switch on the throttle lever.</p>	<p>2. Speed brake extension/retraction switch on the engine throttle [B]</p>
 <p>The image block contains three sub-images. The top-left image shows a cockpit view of the throttle quadrant with a yellow box highlighting a red emergency retraction lever. The bottom-left image shows a top-down view of the aircraft with yellow boxes on the wings and red arrows indicating the deployment of speed brakes. The right image is a close-up of the emergency retraction lever with a blue arrow pointing to it.</p>	<p>3. Speed brake emergency retraction lever</p>

 <p>The image shows a cockpit instrument panel on the left and a view of the aircraft's landing gear on the right. Yellow callout boxes and arrows point from the instrument panel to a close-up of the landing gear lever. The lever is labeled 'ALIGHTING GEAR UP' and has a red arrow indicating the retraction direction.</p>	<p>4. Landing gear extension/retraction lever [G]</p>
 <p>The image shows a cockpit instrument panel. A yellow callout box and arrow point from a red button on the panel to a close-up of the button. The button is labeled 'EMERG UP' and is located next to a scale with markings for 1, 2, and 3.</p>	<p>5. Landing gear emergency retraction button (Emergency Up) see here</p>
 <p>The image shows a cockpit instrument panel. A yellow callout box and arrow point from a gauge on the panel to a close-up of the gauge. The gauge is labeled 'HYD PRESS' and 'PSI x1000' and has a scale with markings for 0, 2, and 4.</p>	<p>6. Pressure indicator, common to all three hydraulic systems</p>

	<p>7. Pressure indicator switch for selection of one of the three hydraulic systems: UTILITY-NORMAL-ALTERNATE. A warning light indicating activation of the alternate booster HS</p>
	<p>8. Button on the control stick [S] for activation of the nose wheel steering system. In addition to the button, one of the rudder pedals must be pressed</p>
	<p>9. Flight control stick that activates the hydraulic booster actuating rods in the pitch and roll control channels</p>

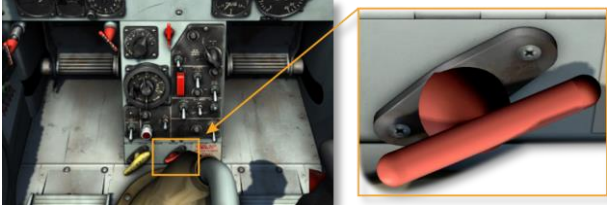
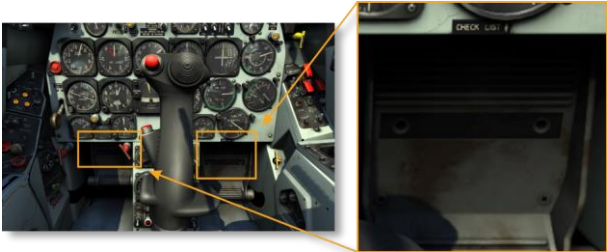
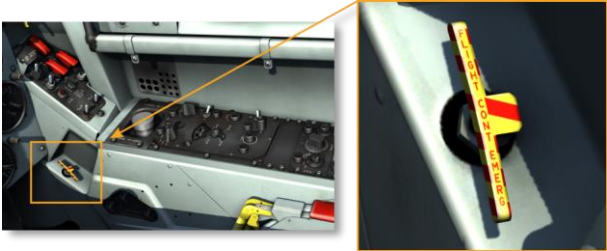
	<p>10. Landing gear emergency extension handle: supplies the utility HS residual pressure to the landing gear hydraulic actuators</p>
	<p>11. The upper (deflectable) parts of the rudder pedals that activate the wheel braking system [W]</p>
	<p>12. Handle for manual switch to alternate booster HS in case of electrical circuit failure</p>

5.4.3. Utility hydraulic system and related systems

Scheme of the utility hydraulic system

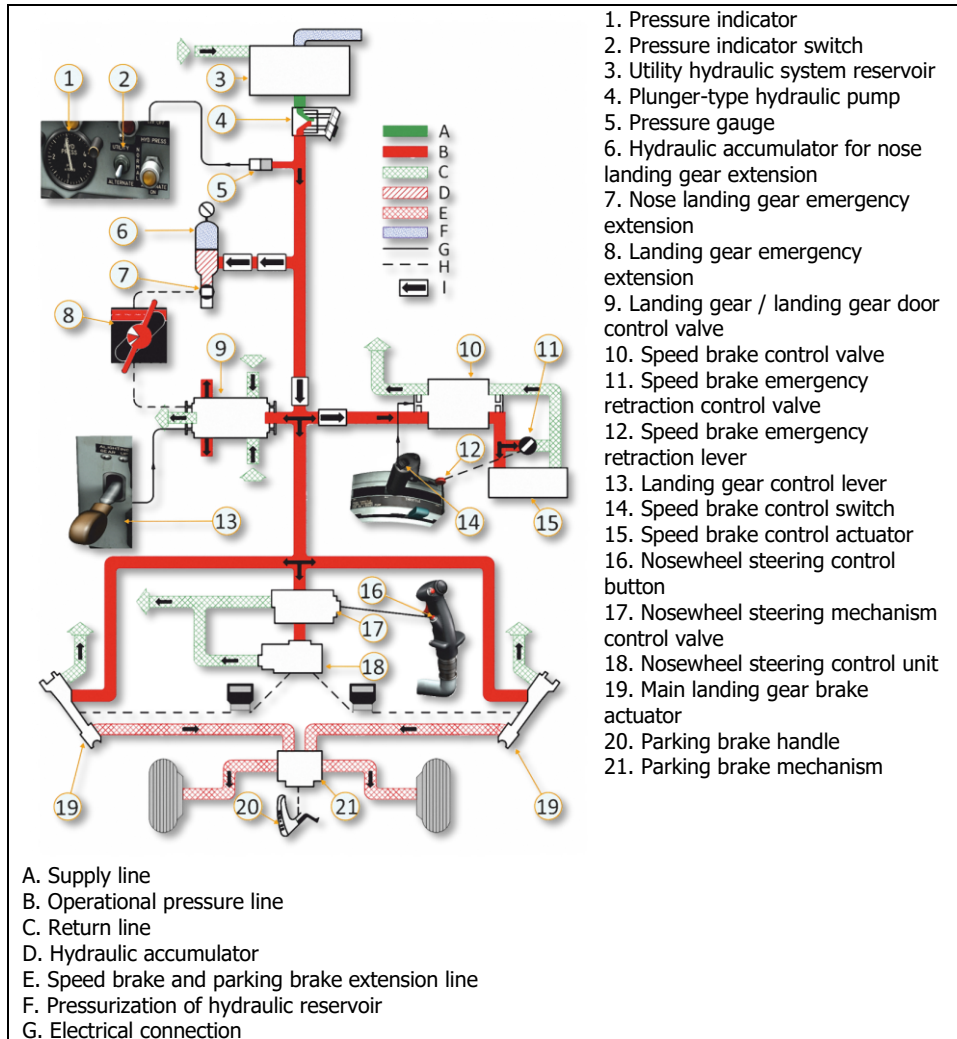

Figure 5.7. Scheme of the utility hydraulic system

The hydraulic fluid comes into the system from a reservoir located in the fuselage on the right side. The pressure in the normal booster hydraulic system is maintained by a plunger-type pump actuated by the engine rotor.

Landing gear extension/retraction system

The system has hydraulic actuators supplied by the utility hydraulic system. To connect the hydraulic actuators to the landing gear extension/retraction lines, there is an electromagnetic valve connected to the primary electrical bus. To control the valve, there is a landing gear control handle in the cockpit located



at the bottom of the instrument panel.



The main gears are retracted to their bays in the fuselage and the wing. The nose gear is retracted to its bay in the fuselage. For retraction, the nose wheel rotates 90 degrees as the gear folds so that the wheel ends up horizontal relative to the aircraft's belly. This allows the nose gear to fit in a small bay between the air intake and the fuselage skin.

After both retraction and extension, the landing gear protective doors are closed and locked thereby creating a smooth airflow in flight and preventing an ingress of dust and dirt on the ground.

The landing gear extension takes approximately 5 seconds while retraction takes approximately 4 seconds. The main wheels are equipped with hydraulic brakes supplied by the utility hydraulic system.

The *LANDING GEAR POSITION INDICATOR* has markings for the three positions of the landing gear:



unsafe warning indication (intermediate position)	
landing-gear-down indication	

The main wheels are equipped with disc brakes powered by the utility hydraulic system. The disc brakes are activated when the upper (deflectable) parts of the rudder pedals are pressed (**[W]** key).

Landing gear emergency-up button

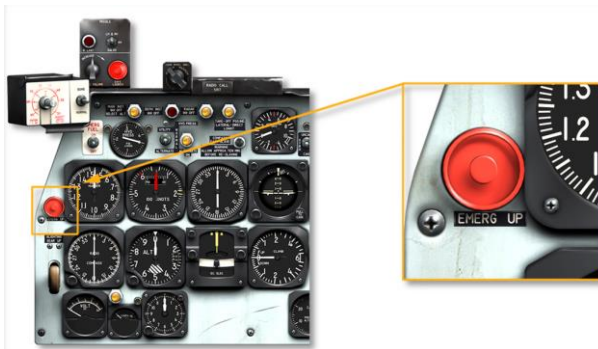

In the real F-86, the emergency gear retraction system was designed to allow the landing gear to be retracted during maintenance as well as during engine failure on takeoff when the engine failed at rotation speed on a short runway and there was not enough room to stop. The early ejection seats were not survivable at ground level. Therefore, the emergency gear retraction system was implemented to give pilots a chance if they lost an engine on takeoff.

When the emergency gear retraction button was pressed, it would cause the landing gear to smash through the gear doors (not modeled). This was because the emergency gear retraction system had its own complete hydraulic line system and did not send any pressure to the gear doors to open them.

In the simulation, the system does not have its own hydraulic line. Therefore, before the emergency gear retraction button is pressed, the landing gear control handle must be in the up position to allow the gear doors to open. If the emergency gear retraction button is pressed with the landing gear control handle in the down position, the gear will not retract.

Gear Emergency Release Handle

In case of pressure drop in the utility hydraulic system and electrical power loss, the landing gear can be extended using an emergency extension lever



located on the [emergency control panel](#) (under the armament panel).

To extend the landing gear in the emergency mode, push down the landing gear control handle (for gear extension) and pull the emergency extension handle all the way back.

Note. The main landing gear, after a forced release of the uplocks, is extended by residual hydraulic pressure and by gravity. The nose gear, due to the necessity of it being turned 90°, receives pressure from a special hydraulic accumulator that has a pressure charge sufficient for one extension.

Nosewheel steering system

The nose wheel steering is supplied by the pressure in the utility hydraulic system and is controlled by the rudder pedals and the steering activation button

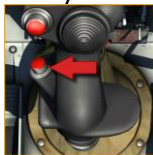

on the control stick.

The nose wheel steering range is $\pm 21^\circ$. To steer, press and hold down the steering activation button [S] and then apply pressure to either the left or right rudder pedal, [Z] or [X] respectively.

Note. The nose wheel steering system will not engage if the nose wheel is more than 21° to either side of center. Should the nose wheel be turned more than this, it must be brought into the steering range by use of the wheel brakes.

When the nose wheel steering activation button on the control stick is released, the nosewheel steering system starts to work as a shimmy damper and the nose wheel goes to the self-castoring mode.

5.4.4. Booster hydraulic systems

The aircraft has two fully independent booster hydraulic systems: normal and alternate ([Figure 5.8](#)).

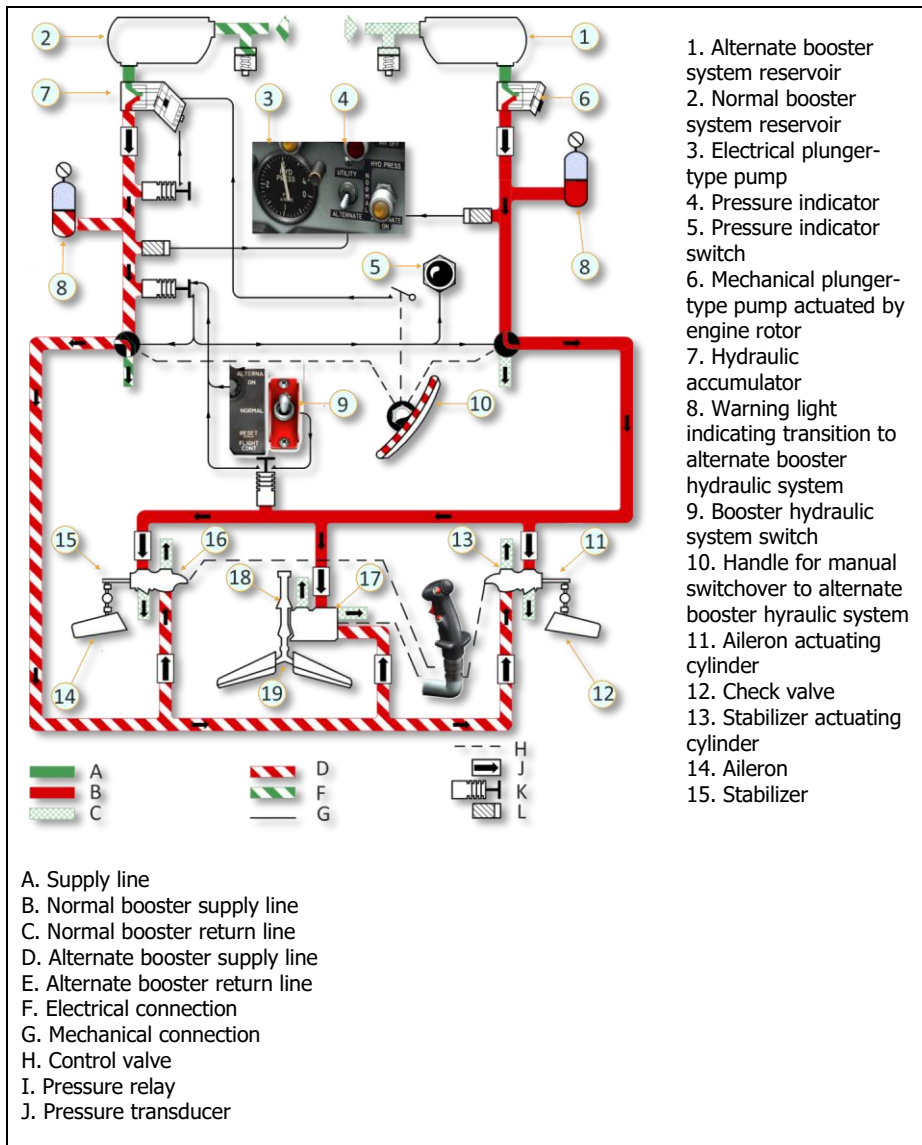
Scheme of the booster hydraulic systems

Figure 5.8. Scheme of booster hydraulic systems

General description

Each of the booster systems is capable of completely relieving the loads on the control stick which arise when control surfaces (ailerons, stabilizers, elevators) change their deflection. These loads are relieved by means of hydraulic fluid being supplied to the control system's actuating cylinders. The actuating cylinders have two cavities – one supplied by the normal booster system, the other by the alternate booster system. Since only one hydraulic system can be operative at a given time, only one of the two cavities can be active at once.

Normal booster hydraulic system

The normal booster hydraulic system is the primary source of hydraulic pressure to the aircraft's control surfaces. In the normal booster hydraulic system, the pressure is maintained by a plunger-type pump mechanically connected to the engine rotor gearbox. The system has a separate reservoir independent of the alternate system which maintains a normal operating pressure of approximately 3,000 PSI. However, if a large force is applied to the control stick, the pressure may decrease slightly before recovering.

Alternate booster hydraulic system

The alternate booster hydraulic system takes over all the functions of the normal booster hydraulic system if the latter fails. The pressure in the alternate booster hydraulic system is maintained by an electrically-driven, plunger-type hydraulic pump supplied both by the battery and the primary bus. The operation of the hydraulic pump is controlled by a pressure relay that automatically connects the pump to the DC circuit under certain conditions (see below).

Operation of the booster hydraulic systems

Proofreader's notes:

This section seems to contradict how the simulation behaves. First, I could not locate the circuit breakers ALT HYD PUMP, EMERG HYD CONT, or ALT HYD CONTROL. Next, the operation of the alternate booster HS pump doesn't seem to be dependent on the pressure in the normal booster HS. From my observation, the alternate booster HS pump will continue to work until the pressure in the the alternate booster HS reaches 3,200 psi. Then the pressure in the alternate booster HS will be allowed to bleed off until it reaches 2,500 psi, causing the pump to turn on again. Finally, the transition from the alternate

booster HS to the normal booster HS is not automatic. It has to be manually reset.

If the circuit breakers ALT HYD PUMP and EMERG HYD CONT are on and the battery is on (i.e. in the BATTERY position), the electrical pump of the alternate booster hydraulic system also turns on. In this case, until the engine is started and the pressure in the normal booster HS exceeds 2750 PSI, the electrical pump of the alternate booster HS continues working. After the engine start, the pressure in the normal booster HS increases and the alternate booster HS automatically goes to the standby mode.

Transition from the normal to alternate booster HS is done automatically as soon as the pressure in the normal HS drops below 650 PSI. It is indicated by the ALTERNATE ON warning light on the instrument panel. The switch from the



normal to alternate booster HS is used for checking the transition function during maintenance activities and as a backup to automatic transition in case of a real failure.

Notes . 1. An automatic or manual transition from the normal to alternate booster HS will not be possible if the pressure level in the alternate system is below the operating pressure.

2. If the primary bus is powered, and the circuit breakers ALT HYD PUMP and EMERG HYD CONT are on, the pump of the alternate booster HS will always automatically turn on as soon as the pressure in the alternate booster HS drops below 2750 PSI;

3. If there is no power on the primary bus, but the circuit breakers ALT HYD PUMP and ALT HYD CONTROL are on, and there is **no weight** on the nose wheel (there is a microswitch), the alternate booster HS pump will automatically turn on if the pressure in the normal booster HS is below 2750 PSI. If there is weight on the nose wheel, the pump will not turn on.

Thus, the operation of the alternate booster HS pump does not depend on the position of the ALTERNATE ON – NORMAL – RESET switch. This switch only chooses the system that will supply pressure to the actuating cylinders.

5.5. Engine anti-ice and protective screen systems

Protection of the engine from ice build-up and ground debris is done via the three-position anti-ice and protective screen switch in the cockpit (Figure 5.9). In the EXTEND position, the engine inlet protective screens are extended and prevent the ingress of foreign objects during engine operation on the ground. In the RET position, the protective screens are retracted. During icing conditions in flight, the switch must be set to ANTI-ICE.



Figure 5.9. Engine protection switch

Engine anti-ice system

All the parts of the engine inlet with an exposed frontal area have anti-ice protection except for the inlet protective screens.

The engine inlet front lip and compressor inlet guide vanes are continuously and automatically heated by the compressed air when the ANTI-ICE position is selected on the anti-ice and protective screen switch.

After the anti-ice system is turned on, the hot air from the compressor starts flowing to the engine inlet front lip and the engine protective cone. To prevent overheating of the fairing, there is a thermal fuse in the system with a thermostatic switch that controls hot air supply. When the anti-ice system is turned

on, the engine inlet protective screens are automatically retracted in order to prevent ice formation on them.

Engine protective screens system

The engine inlet is equipped with a system of eight protective screens that protect the compressor from ingestion of foreign objects on the ground (the ingestion of foreign objects is not simulated in the game). The screens are extended simultaneously into the engine inlet channel when the EXTEND position is selected on the anti-ice and protective screen switch. In flight, they must be retracted using the RET position of the switch in order to prevent ice from forming on them and causing engine damage.

5.6. Engine fire indication system



Figure 5.10. Fire indication system

- | | |
|--|--|
| 1. Circuit switch for engine fire indication system | 3. Warning light for fire in aft engine sections |
| 2. Warning light for fire in forward engine sections | |

The purpose of the engine fire indication system is to annunciate engine fire. The system includes fire detectors and cockpit warning lights.

The fire detectors are installed in the forward (compressor and gearbox) and aft (combustion chamber and tail pipe) engine sections separated by a firewall.

The engine does not have a fire extinguishing system.

5.7. Air pressurization and conditioning system

Two independently controlled life support systems use the air coming out of the compressor last stage.

General scheme

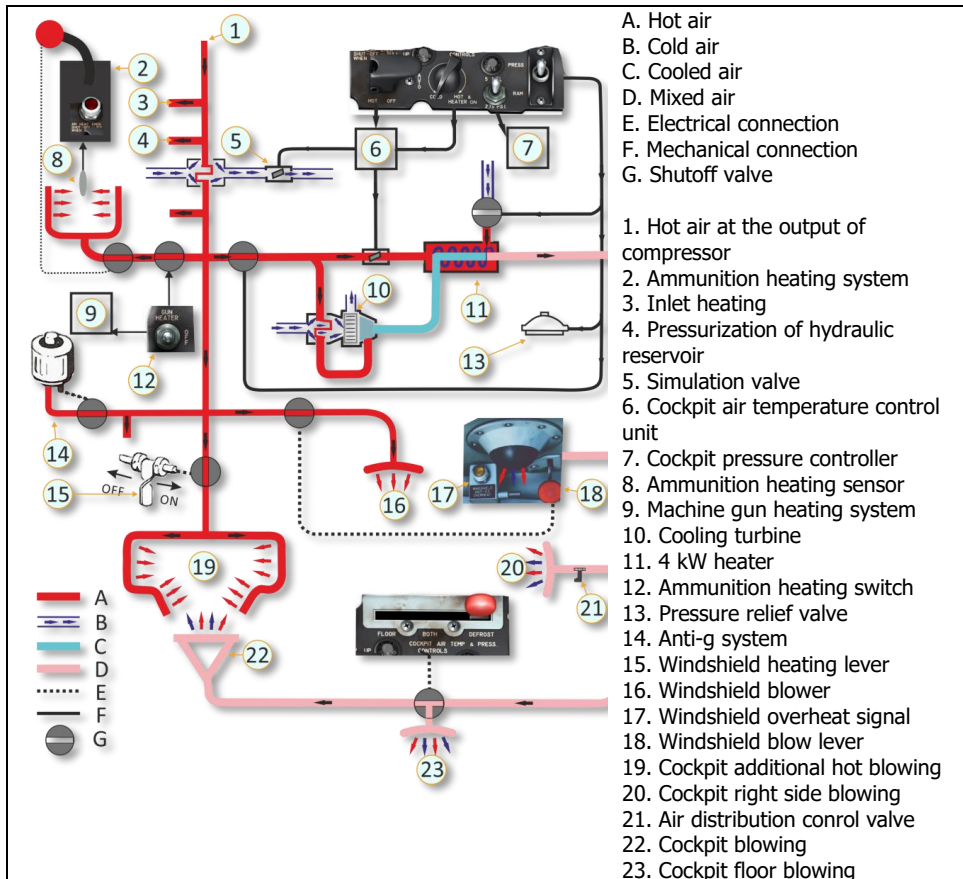

Figure 5.11. Air pressurization and conditioning system

5.7.1. System operation

Hot air is initially cooled in the primary heat exchanger and then separated into two airflows. One flow remains at the initial level of cooling and is used to directly supply the systems that need compressed air:

- anti-g suit;
- cockpit pressurization;
- pressurization of external fuel tanks;
- ammunition bay blowing;
- windshield blowing.

The other flow goes through the electronic air temperature control unit to the cockpit through vent holes. If there is a need for cooler air in the cockpit, the control unit's electronic valve diverts the air for additional cooling.

The pressure in the cockpit is maintained by airflow from the vent holes and is regulated by the differential pressure controller.

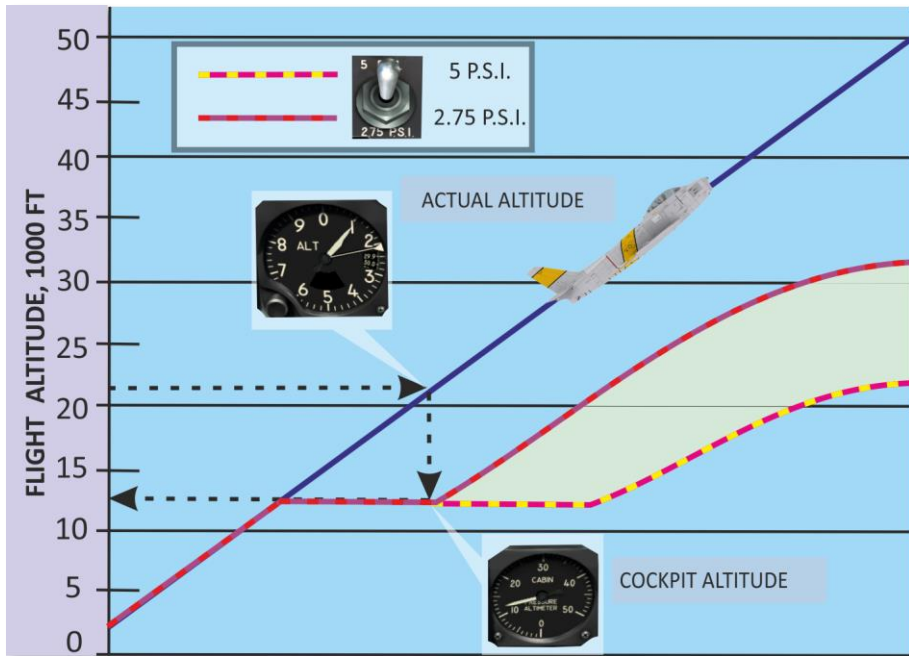

Figure 5.12. Operation of cockpit pressurization system

Note. The air used for the air pressurization and conditioning system is taken from the output of the compressor. Hence, for normal operation of the system, it is important to maintain certain engine rpm depending on the flight altitude, see Table 5.2.

Table 5.2

Flight altitude, ft	Engine rpm,%
10,000	70
15,000	73
20,000	75
30,000	80
40,000	92
45,000	100

5.8. Oxygen System

The oxygen system serves the function of supplying sufficient oxygen to the pilot in flight.

It is comprised of four oxygen storage cylinders, lines, check valves, and an oxygen regulator (refer to [Figure 5.13](#)).

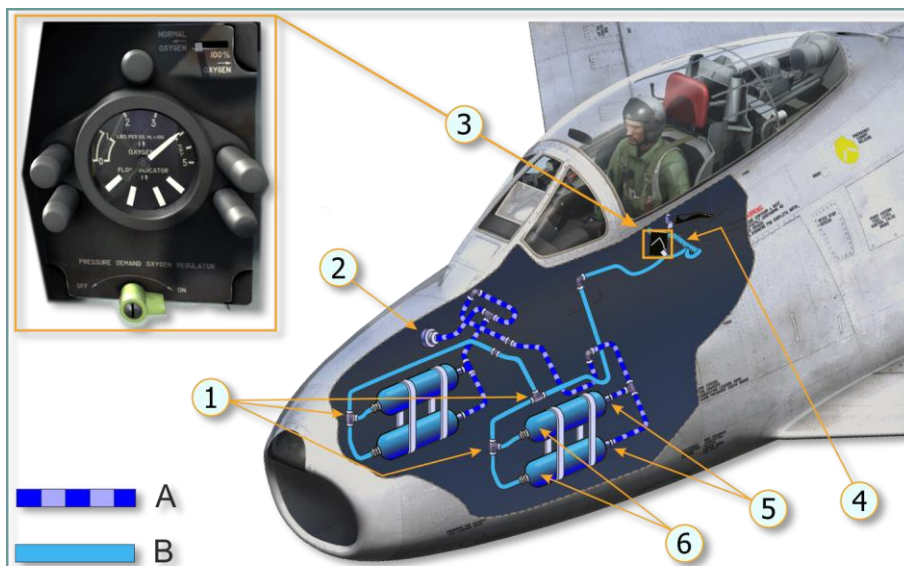

Figure 5.13. Oxygen System

A – Oxygen filler lines
 B – Oxygen supply lines
 1. Check valve
 2. Filler valve
 3. Oxygen regulator

4. Mask tube with oxygen mask connection
 5. Check valve (typical 4 places)
 6. Oxygen cylinders

(A) – OXYGEN FILLER LINE allows connection of the ground unit connectors to the oxygen cylinders;

(B) – OXYGEN SUPPLY LINE;

(1) – CHECK VALVES (IN THE SUPPLY LINE) automatically isolate cylinders and relevant supply line sections from the oxygen system in the event of failure (thus, oxygen supply will continue despite leaks from punctured cylinders or lines damaged upstream of the check valve even if only one cylinder remains intact);

(2) – FILLER VALVE allows ground unit connection to the oxygen filler line (not modelled in the game);

(3) – OXYGEN REGULATOR;

(4) – MASK TUBE WITH OXYGEN MASK CONNECTION;

(5) – *CHECK VALVES (IN THE CYLINDERS' FILLER LINE)* prevent oxygen leaks from cylinders in case of damage to filler line;

(6) – *OXYGEN CYLINDERS* store oxygen onboard.

Oxygen Regulator

For oxygen regulator, refer to [Figure 5.14](#).



Figure 5.14. Oxygen regulator

- | | |
|-------------------|-------------------|
| 1. Diluter Lever | 3. Flow Indicator |
| 2. Pressure Gauge | 4. Supply Lever |

(1) – *DILUTER LEVER* selects the oxygen ratio in the mixture and has two positions: NORMAL OXYGEN (oxygen ratio is adjusted automatically depending on cockpit pressure) and 100% OXYGEN (mixture is 100% oxygen for emergency conditions);

(2) – *PRESSURE GAUGE* displays the pressure in the oxygen cylinders in hundreds of pounds per square inch (LBS PER SQ.IN or PSI). Fully charged cylinders show a pressure of 400 PSI;

(3) – *FLOW INDICATOR* shows oxygen flow through alternating black and

white slots  ;

(4) *SUPPLY LEVER* allows oxygen to be cut off from the oxygen mask. In the simulation, the oxygen mask is considered to be on the pilot's face at all times. Therefore, if the supply lever is off, the pilot may "lose consciousness" within

30-40 seconds from a lack of oxygen. So, this lever should be ON at all times.



Oxygen System Operation

Normal operation of the system (diluter lever set to NORMAL OXYGEN) ensures proportional mixing of pure oxygen and air dependant upon flight altitude and supply of the mixture to the oxygen mask. A 100% oxygen supply is available if the diluter lever is set to 100% OXYGEN.

How long the onboard oxygen supply lasts, vary depending on flight altitude, system operation conditions, and current pressure in the cylinders. Feeding duration (in hours) is given in [Table 5.3](#).

Table 5.3

cabin alt.ft	Mode	GAGE PRESSURE – PSI						
		400.0	350.0	300.0	250.0	200.0	150.0	100.0
40,000	100% OX.	5.7	4.9	4.1	3.2	2.4	1.6	0.8
	NORMAL OX.	5.7	4.9	4.1	3.2	2.4	1.6	0.8
35,000	100% OX.	5.7	4.9	4.1	3.2	2.4	1.6	0.8
	NORMAL OX.	5.7	4.9	4.1	3.2	2.4	1.6	0.8
30,000	100% OX.	4.3	3.6	3.0	2.4	1.8	1.2	0.6
	NORMAL OX.	4.3	3.6	3.0	2.4	1.8	1.2	0.6
25,000	100% OX.	3.4	2.9	2.4	1.9	1.4	1.0	0.5
	NORMAL OX.	4.0	3.4	2.8	2.3	1.7	1.1	0.6
20,000	100% OX.	2.7	2.3	1.9	1.5	1.2	0.8	0.4
	NORMAL OX.	4.5	3.9	3.2	2.6	1.9	1.3	0.6
15,000	100% OX.	2.1	1.8	1.5	1.2	0.9	0.6	0.3
	NORMAL OX.	5.4	4.6	3.9	3.1	2.3	1.5	0.8
10,000	100% OX.	1.8	1.5	1.3	1.0	0.7	0.5	0.3
	NORMAL OX.	7.2	6.2	5.2	4.1	3.1	2.1	1.0

Oxygen System Preflight Check

1. Check oxygen supply lever is safetied ON ;



2. Check oxygen pressure gauge reads 400 PSI ;



3. Set diluter lever to NORMAL OXYGEN

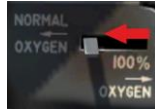

5.9. Lighting Equipment

The lighting equipment enables aircraft employment at night. It includes the *INTERIOR LIGHTING SYSTEM* and *EXTERIOR LIGHTING SYSTEM*.

5.9.1. Interior Lighting System

The system allows the pilot to view the instrument readings and see most of the cockpit controls during night time.

The system consists of:

- Instrument Ring Lights;
- Left and Right Console Floodlights;
- Integral Lighting for the Left and Right Consoles;
- Left and Right C-4A Cockpit Utility Lights;
- Cockpit Light Rheostat Panel;
- Circuit Breakers associated with the lighting equipment power supply.



Figure 5.15. Lighting Controls Location in F-86F-35 Cockpit

- | | |
|--|-------------------------------------|
| 1. C-4A Left Cockpit Utility Light | 5. Right Console Floodlight |
| 2. Left Console Floodlight | 6. Cockpit Light Rheostat Panel |
| 3. Integral Lighting for the Left and Right Consoles | 7. C-4A Right Cockpit Utility Light |
| 4. Instrument Ring Lights | |

(1) *C-4A LEFT COCKPIT UTILITY LIGHT* is fitted to the left of the pilot's seat and provides additional illumination of the load control console, the left forward console, as well as the left portion of the instrument panel and is independent



of the instruments' dedicated integral lighting

(2) *LEFT CONSOLE FLOODLIGHT* provides additional illumination of the left



side console

(3) *INTEGRAL LIGHTING FOR THE LEFT AND RIGHT CONSOLES* illuminates



aircraft equipment controls located on the left

and



right consoles. Lights are directly integrated into the consoles (i.e. light is emitted from within the body of the console object);

(4) *INSTRUMENT RING LIGHTS* are used to illuminate instruments



(5) *RIGHT CONSOLE FLOODLIGHT* provides additional illumination of the control panels for the following equipment: radio compass, radio set, and IFF



(6) *COCKPIT LIGHT RHEOSTAT PANEL* allows lighting brightness control for different cockpit objects through the use of rheostats (refer to [Figure 5.16](#)).

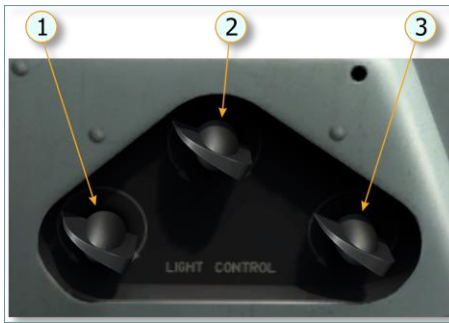

1. Left rheostat – controls the brilliancy of utility lights (1) & (7)
2. Middle rheostat – controls the brilliancy of left and right console floodlights (2) & (5), as well as integral lights for left and right consoles (3)
3. Right rheostat – controls the brilliancy of integral ring lights for instruments within the instrument panel as well as for adjustment dials for equipment on left and right consoles

Figure 5.16. Cockpit Light Rheostat Panel

Examples of brilliancy control with rheostats:

	Left rheostat fully CLOCKWISE, other rheostats fully COUNTER-CLOCKWISE
	Middle rheostat fully CLOCKWISE, other rheostats fully COUNTER-CLOCKWISE



Right rheostat fully
CLOCKWISE, other
rheostats fully
COUNTER-
CLOCKWISE

(7) *C-4A RIGHT COCKPIT UTILITY LIGHT* is fitted to the right of pilot's seat and provides additional illumination of the forward console and the right portion of the instrument panel and is independent of instruments' dedicated integral



lighting

Bulbs are rated for 27-29V. Therefore, if the generator is not running (or there is insufficient engine RPM), the lighting will only glimmer even when rheostats on the panel are in the full clockwise position.

Apart from cockpit lighting, a dedicated pilot's light is provided in the game which can be enabled with [[LAit + LJ](#)]:



Figure 5.17. Enabling Pilot's Light

The pilot's light is controlled by moving the mouse as required.

5.9.2. Exterior Lighting System

Ensures that the aircraft is visible at a safe distance to other airspace users and provides illumination of the taxi lanes and runway for the pilot during taxiing, take-off, and landing at night ([Figure 5.18](#)).



Figure 5.18. Appearance of the Aircraft at Night, Exterior Lights On

The system includes:

- Five position and fuselage lights ([Figure 5.18](#)):
 - Red left light;
 - Green right light;
 - Two tail lights – one orange (on the left) and one white (on the right);
 - An underbelly light.
- Retractable landing and taxiing lights;
- Rack-mounted warning lights (not implemented);
- Exterior lighting system controls:
 - Position and Fuselage Light Selector Switch (STEADY-OFF-FLASH);

- Dimmer Switch (BRIGHT-DIM);
- Landing and Taxi Light Switch (also used to extend/retract the lights).

TAIL LIGHTS are located close to one another:



LANDING (1) AND TAXI (2) LIGHTS are set side by side and are extended

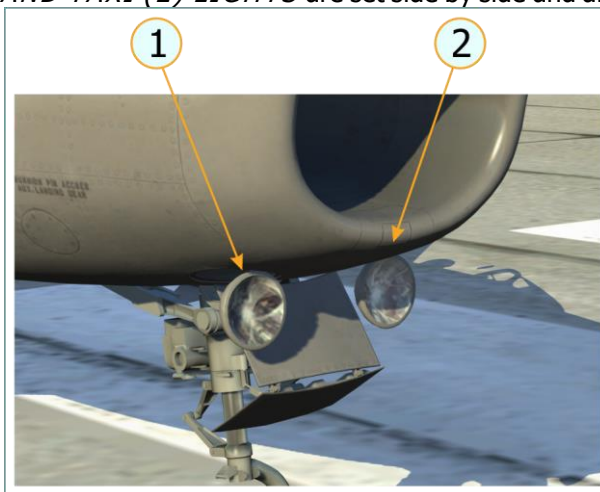

simultaneously:

Landing light operation

The landing light operates at greater power than the taxi light and requires ram air cooling. For this reason, a microswitch fitted on the nose gear is

incorporated into the light's circuit. The microswitch is normally open with weight on wheels. Therefore, when the nose wheel touches the ground, the microswitch automatically turns off the landing light. If the LAND & TAXI LTS switch is in the EXTEND & ON position, the landing light goes on as soon as weight is removed from the nose strut.

Description of cockpit objects related to exterior lighting system

	<p>1. Left – Dimmer Switch for position and fuselage lights, BRIGHT-DIM; 2. Right – Position and Fuselage Light Selector Switch, STEADY-OFF-FLASH</p>
	<p>Landing and Taxi Light Switch (EXTEND & ON – to extend and switch the lights on; OFF – to extinguish extended lights; RETRACT – to retract the lights)</p>

All of the aircraft's lighting systems are connected to the 27-29 VDC network.

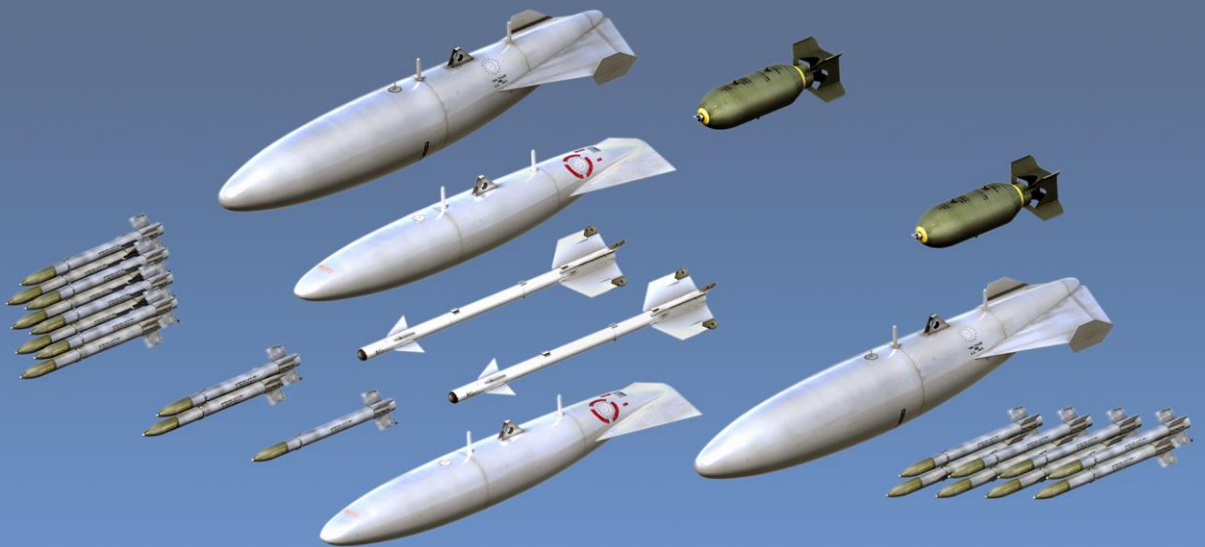

6

WEAPONS

6. WEAPONS

6.1. Overview, Structure, and Variants

6.1.1. Overview and Structure

Overview

The aircraft weapon systems include the installed armament, the weapon configuration controls, and the sight controls used for aimed delivery.

Structure

The aircraft weapon systems are comprised of both individual units and subsystems, specifically:

- aircraft weapon racks and weapon release subsystems;
- general weapon and sight controls.

The weapons and armament subsystems include:

- gunnery – six 12.7 mm machine guns with 300 rounds each and relevant cockpit controls;
- bombing equipment – up to two 500 lbs bombs, a low-altitude bombing system, manual pip control bombing system, and relevant cockpit controls;
- rockets – up to 16 HVAR rockets (5 inch) and relevant cockpit controls;
- missiles – two GAR-8 missiles (with IR seekers) and relevant cockpit controls;
- sight equipment – the A-4 semi-automatic telescopic sight with sight adjustments and controls and the AN-N6 sight reticle camera;
- radar – the AN/APG-30 radar ranging unit.

Section [6.10](#) briefly describes all the cockpit systems associated with weapons employment.

Note. Some weapon system controls are associated with subsystems and are, therefore, mentioned in the descriptions of those subsystems.

6.1.2. F-86F-35 Weapons Variants, Racks, and Stores Release Subsystem

Depending on the particular mission, the aircraft may be equipped either for air-to-air combat or ground attack. In addition, the aircraft can be equipped with a mixed configuration of weapons, [Figure 6.1](#).

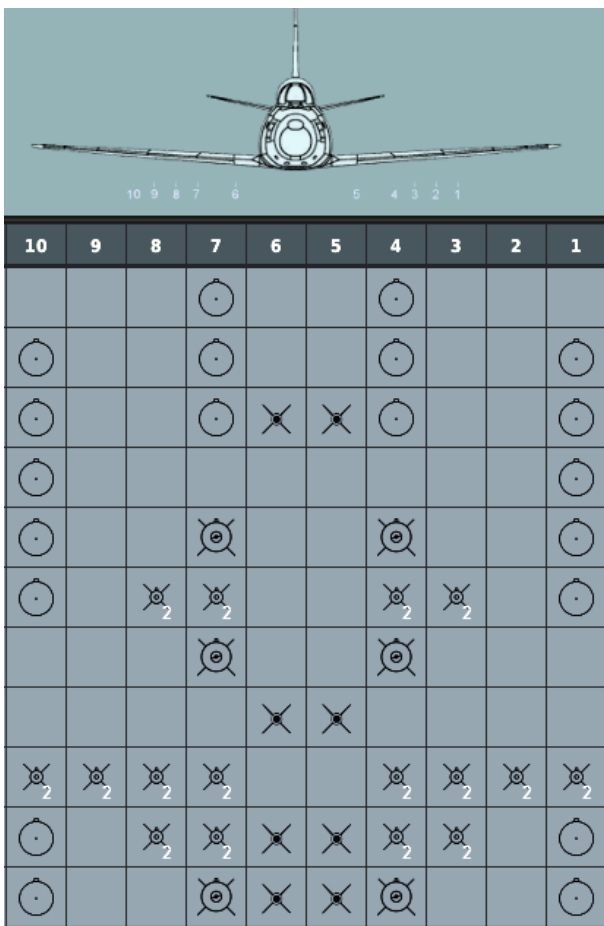
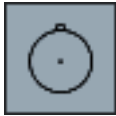

Figure 6.1. Primary Weapons Variants of F-86F-35

Legend:



– drop tanks;



– GAR-8 missiles (prototype of AIM-9);



– AN-M64 bombs, 500 lbs;



– HVAR rockets, 5" (installed in pairs).

When the F-86 was in its design phase, stores standardization had not yet been introduced. Therefore, different racks are required for rockets, bombs, missiles, and drop tanks. There are no specific limitations on which types of weapons can be installed at any one time although the sizes of adjacent weapons must be taken into consideration. Therefore, various weapons combinations are possible based on tactical considerations.

Weapons Racks

The aircraft can be furnished with racks for tanks, bombs, rockets, and missiles:

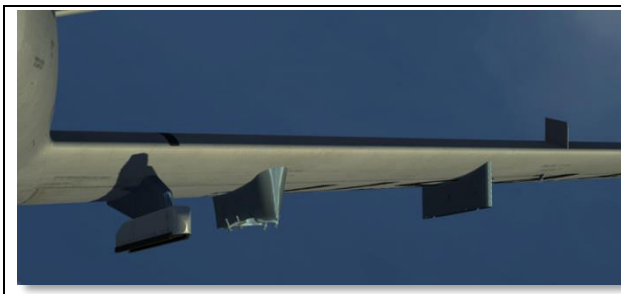

Pylons for missiles, bombs, and tanks (left to right)

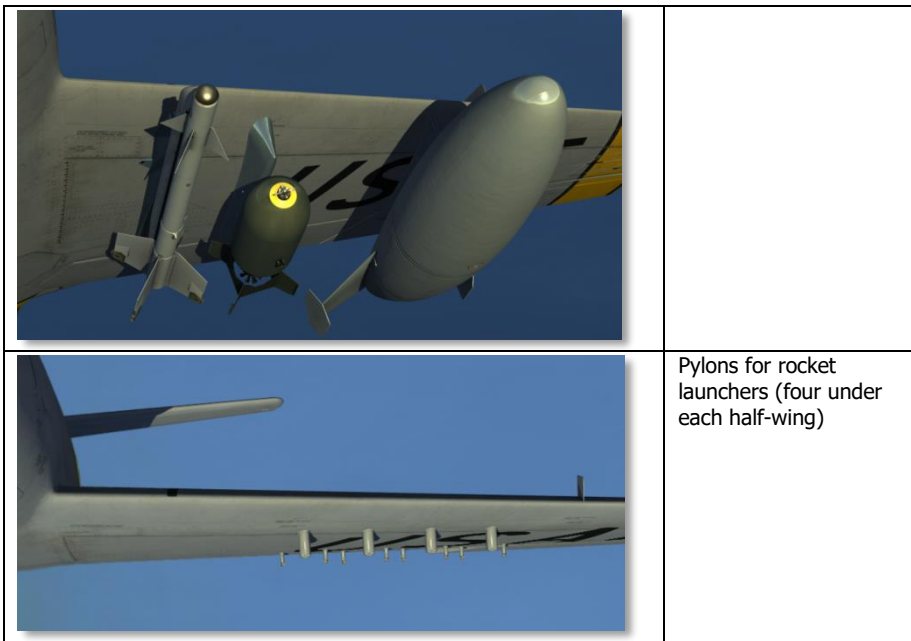

Rocket installation on the launchers has some peculiarities. The rockets are installed in two tiers with the upper rocket attached by three points: one front mount and two rear mounts. Two of the rocket fins are used to attach the rocket to the rear mounts:



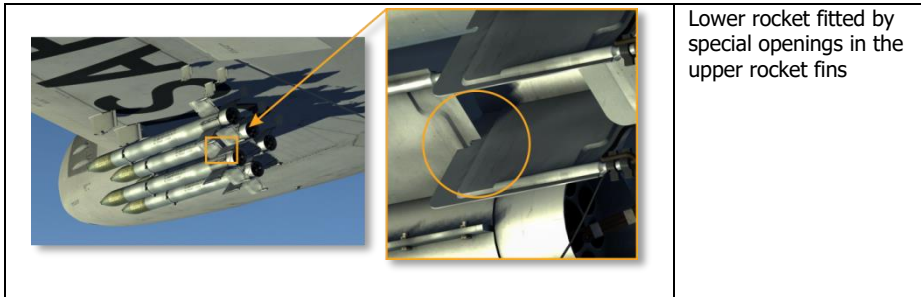

Since the lower rocket is installed via a structural element in the upper rocket, the upper rocket can not be launched if a lower rocket engine failure occurred (rocket failure is not simulated).

Stores Release Subsystem

The stores release subsystem includes relevant switches in the center pedestal ([Figure 6.2](#), 3,7,8,10), a jettison button on the stores control panel, release electrical circuits (closed by the bomb-rocket release button on the control stick), and [mechanical](#) and [electrical](#) emergency release subsystems.

Depressing the jettison button jettisons all stores except for missiles.

6.2. General Weapons and Sight Controls

6.2.1. Weapons Control Center Pedestal

Controls various functions of the weapons and sight subsystems.





Figure 6.2. Weapons Control Center Pedestal

- | | |
|--|---|
| <p>1. Gun-Missile Selector Switch (OFF – SIGHT CAMERA&RADAR – GUNS – MISSILE)</p> <p>2. Guns Heater</p> <p>3. Rockets Jettison Switch</p> <p>4. Rocket Release Selector Switch (SINGLE – OFF – AUTO)</p> | <p>5. Filament Selector Switch (PRIMARY – SECONDARY)</p> <p>6. Fragmentation Bomb Selector Switch (ALL TRAIN – OFF – SINGLE TRAIN)</p> <p>7. Fragmentation Bombs Indicator Light</p> <p>8. Instrument Power Switch (ALTERNATE – NORMAL)</p> |
|--|---|

- | | |
|--|-----------------------------------|
| 5. Rocket Fuze (Arming) Switch (FUZE DELAY – OFF – INSTANT) | 13. Sight Selector Unit |
| 6. Bomb-Arming Switch (ARM NOSE&TAIL – TAIL ONLY) | 14. Bomb-Target Wind Control Knob |
| 7. Demolition Bomb Sequence Selector Switch (ALL – OFF – LEFT – RIGHT) | 15. Knob not in use |
| 8. Demolition Bomb Release Selector Switch (AUTO RELEASE – MANUAL RELEASE) | |

(1) GUN-MISSILE SELECTOR SWITCH OFF – SIGHT CAMERA&RADAR – GUNS – MISSILE:

- OFF – all circuits supplying gunsight (gyro and backlight), camera, radar, gun firing, and missile launching are disabled;
- SIGHT CAMERA&RADAR – gunsight and camera operate in normal mode while gun firing and missile launching circuits are disabled;
- GUNS – gunsight and camera operate in normal mode, gun firing circuits are enabled, and missile launching circuits are disabled;
- MISSILE – gunsight and camera operate in normal mode, missile launching circuits are enabled, and gun firing circuits are disabled.

Note: Bomb and rocket circuits are not dependant on the position of the Gun-Missile Selector Switch.

(2) GUN HEATER. An electric heater is mounted on each gun. It is used at low temperatures (+1.7°C and below) and high humidity to prevent the gun from jamming (not simulated).

(3) ROCKETS JETTISON SWITCH. Prepares the rockets for emergency jettisoning via the bombing equipment circuit. Placing at READY closes the rockets jettisoning circuit. The rockets can then be jettisoned by depressing the bomb-rocket release button on the control stick. This method of rockets jettisoning can be used when both rockets and drop tanks are being carried and it is desired to jettison only the rockets.

(4) ROCKET RELEASE SELECTOR SWITCH (SINGLE – OFF – AUTO). When the selector is at SINGLE (up), one rocket is fired each time the bomb-rocket release button is depressed on the control stick. When the selector is at AUTO (down), rockets will fire in train while the release button is depressed. When the selector is at OFF (center), no rockets can be fired. The rocket release selector switch is inoperative if ROCKETS JETT READY is on (up). In this case, all rockets will drop simultaneously.

(5) *ROCKET FUZE (ARMING) SWITCH* (FUZE DELAY – OFF – INSTANT) is used to set the rocket detonation delay. When the switch is at INSTANT, the rocket nose fuze is armed to provide detonation upon impact. When the switch is at DELAY, an internal fuze is armed causing a relatively small delay of detonation after impact. If the switch is placed at OFF, a rocket explodes with internal fuze detonation. If the rockets are jettisoned, their fuzes are unarmed.

(6) *BOMB-ARMING SWITCH* (ARM NOSE&TAIL – TAIL ONLY) Used for the demolition bombs. When the switch is at the ARM NOSE&TAIL position, both nose and tail fuzes are armed causing the bombs to explode instantly upon impact. Bringing the switch to the TAIL ONLY position arms only the tail fuze resulting in delayed detonation. If the switch is placed at NEUTRAL, bomb fuzes remain unarmed.

(7) *DEMOLITION BOMB SEQUENCE SELECTOR SWITCH* (ALL – OFF – LEFT – RIGHT). With the switch placed at ALL, both demolition bomb racks are tripped simultaneously when the bomb-rocket release button is depressed. Positioning the switch at LEFT will trip the left bomb rack when the bomb-rocket release button is depressed. Depressing the bomb-rocket release button a second time will then trip the right bomb rack. When positioning the switch at RIGHT, the method of employment is similar but reversed with the right bomb dropping before the left. With the switch placed at OFF, no bombs can be dropped (this should be the switch position when not imminently preparing to drop bombs).

(8) *DEMOLITION BOMB RELEASE SELECTOR SWITCH* (AUTO RELEASE – MANUAL RELEASE) determines whether bombs should be released based on certain conditions or released instantly. When the switch is placed at AUTO and the bomb-rocket release button is depressed and held, bombs will be released automatically when the right conditions are met. When the switch is placed at MANUAL, bombs will be released immediately when the bomb-rocket release button is depressed.

(9) *FILAMENT SELECTOR SWITCH* (PRIMARY – SECONDARY) determines which lamp filament will be used (primary or secondary) for the sight aiming reticle.

(10) *FRAGMENTATION BOMB SELECTOR SWITCH* (ALL TRAIN – OFF – SINGLE TRAIN). When placed at ALL TRAIN, the bombs are released in a train from both racks simultaneously when the bomb-rocket release button is depressed. When placed at SINGLE TRAIN, the bombs are released from the left wing rack first and then, if the bomb-rocket release button is held, from the right wing

rack. The switch is not yet implemented since no fragmentation bombs exist in the simulation for the F-86.

(11) *FRAGMENTATION BOMBS INDICATOR LIGHT* indicates that the fragmentation bombs are ready to be released. The light is not yet implemented since no fragmentation bombs exist in the simulation for the F-86.

(12) *INSTRUMENT POWER SWITCH* allows for switching between the main three-phase inverter and the back-up three-phase inverter (refer to [Electrical System](#)).

(13) *SIGHT SELECTOR UNIT* operates in conjunction with the A-4 sight (refer to [6.7.1](#)).

(14) *BOMB-TARGET WIND CONTROL KNOB* is used for employment of [bombs](#) in windy conditions.

(15) Knob not in use.

The remaining weapons and sight controls are described in the relevant sections.

6.3. Gunnery Equipment

6.3.1. General

The gunnery equipment includes six .50-caliber AN/M3 Browning machine guns installed outboard of the cockpit, three on each side.



Figure 6.3. Guns Location



Figure 6.4. Three AN/M3 Guns, F-86 Left Side

For gun specifications, refer to Table 6.1

Table 6.1

AN/M3 Browning Machine Gun	
Caliber	.50-cal (12.7mm)
Rate of Fire	1,200 rounds/min
Muzzle Velocity	890 m/s
One Second Burst Mass	0.87 kg
Ammunition	300 rounds per gun
Cartridge:	
length	99 mm
bullet weight	41.92–51.80 g
bullet energy	15,530–20,257 J



Figure 6.5. 12.7x99 Cartridges

Containers are provided in the lower portion of the fuselage for retaining ejected cases (the cases do not leave the aircraft during firing).

Guns are charged and unloaded on the ground before and after flight. If gun stoppage occurs in the air, it can only be cleared manually on the ground.

Guns and Sight Bore Sighting

The guns are bore sighted parallel to the fuselage reference line. The gun sight line is bore sighted down to intersect the guns' bores at 2,250 feet (686 m). The bore sighting configuration is based on an aircraft gross weight of 15,791 lbs (one-half fuel and full ammunition load) and an unaccelerated flight condition.

Note. In the real F-86, to avoid muzzle contamination after charging, the guns are capped with rubber plugs that are blown off when the guns are fired (not simulated in the game).

6.3.2. Gunnery Equipment

The gunnery equipment circuits are powered from the primary bus.

The respective controls are comprised of the following:

- gun-missile selector switch (GUNS position);
- gun selector switch and indicator lights;
- gun firing trigger (cock shape button) on the control stick;
- machine gun barrels heater switch Center Pedestal.



1. Gun-Missile Selector Switch (GUNS Position)

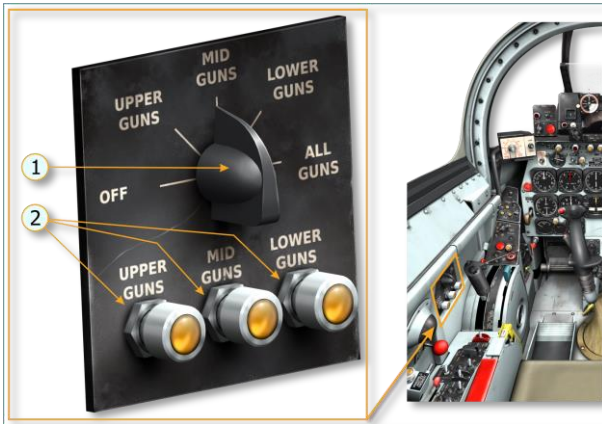

2-1. Gun selector switch for choosing active guns:
 OFF;
 UPPER GUNS;
 MID GUNS;
 LOWER GUNS;
 ALL GUNS.

2-2. Gun indicator lights indicating which guns are ready to fire

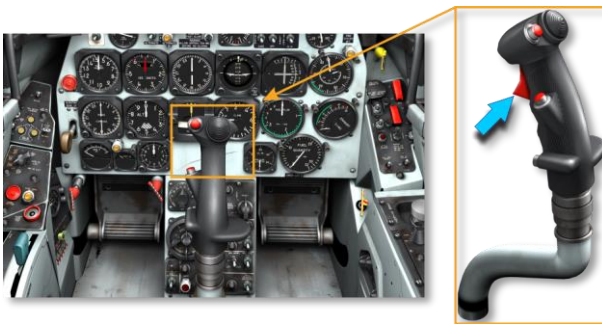

3. Gun Trigger (cock shape button) on the control stick



4. Machine gun barrel heater switch on the Center Pedestal (to prevent jamming of the machine guns due to icing under cold temperature and high moisture)

Apart from the above controls, there is also the [A-4 sight](#) and its adjustment controls. For displaying a gun solution on the A-4 sight, the [Sight Selector Unit](#)



must be switched to GUN . For a description of the Sight Selector Unit and other sight adjustment controls, refer to [6.7.1](#). For a description of gun employment using the A-4 sight, see [6.7.2](#).

6.4. Bombs and Bombing Systems

6.4.1. General

The F-86 in the simulation can carry two 500 lbs AN-M64 bombs ([Figure 6.6](#)) which can be placed only on hardpoints number 4 and 7 (according to the scheme of [Figure 6.1](#)).

Bomb aiming and release can be accomplished through one of the three following methods:

- using the sight without manual pip control (MPC);
- using LABS (Low-Altitude Bombing System);
- using the sight and manual pip control (MPC).

In addition to normal release, bombs and other stores can be emergency-released using the jettison system provided.

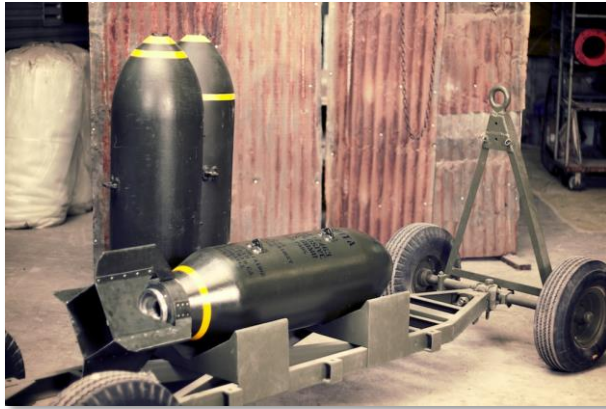

Figure 6.6. The bombs AN-M64 500 lbs



Figure 6.7. Aircraft with Two AN-M64 Bombs



Figure 6.8. Bombs and Tanks Installed

Controls are provided for normal (tactical) and emergency release of bombs. Normal release may be accomplished automatically or manually, with bombs released singly or simultaneously. The condition of bomb nose and tail fuzes, upon release, is selectively controlled. Bombs are always unarmed when emergency-released.

Bomb aiming and automatic release is accomplished through the A-4 sight. In case of an electrical failure, a mechanical system enables emergency release of bombs and other stores without the fuzes being armed. For more details, refer to [Bombing Controls](#).

For AN-M64 bomb details, refer to [Table 6.2](#).

Table 6.2

	Parameter	Value
	Size	500 lbs
	Actual weight	512 lbs / 232.4kg
	Length	150.3 cm
	Case length	119.6 cm
	Case dia.	36.0 cm
	Fins length	33.0 cm
	Fins width	48.0 cm
	Explosive weight	116.5 kg
	Explosive type	TNT/Amatol

6.4.2. Special Store (not simulated)

In the real aircraft, a special store could be carried under the left wing. The special store could be monitored with a control panel on the left console, outboard of the throttle. Also, a mechanical jettison handle was located below the instrument panel to the left of the Center Pedestal (a non-functional jettison handle can be found in the simulation).

6.4.3. Bombing Controls (General)

The bombing system circuits are powered from the primary bus.

The bombing system controls are comprised of:

- the Demolition Bomb Release Selector Switch;
- the Demolition Bomb Sequence Selector Switch;
- the Fragmentation Bomb Selector Switch;
- the Bomb-Rocket Release Button on the control stick;
- the Emergency Jettison Handle;
- the Bomb-Rocket-Tank Jettison Button.

Note. There is some difference in how demolition and fragmentation bombs are released (fragmentation bombs are not yet implemented in the simulator).

Demolition Bomb Release Selector Switch



With the selector switch set to **MANUAL RELEASE**, the bomb is released by depressing the bomb-rocket release button on the control stick. With the selector switch set to **AUTO RELEASE**, the bomb is released automatically by depressing and holding the button on the control stick and waiting for the aircraft's flight conditions (pitch angle, speed, altitude, and G-load) to be sufficient for the bomb to hit the target after release (release point calculated by the mission computer). For fragmentation bombs (not yet implemented in the simulator), the selector switch should be set to **MANUAL RELEASE**.

For the **MANUAL RELEASE – AUTO RELEASE** selector switch to be operative, the demolition bomb sequence selector switch (see below) should be brought to a position other than **OFF (ALL, LEFT, or RIGHT)**.

Demolition Bomb Sequence Selector Switch

The demolition bomb sequence selector switch on the center pedestal has four positions: DEM BOMBS ALL – OFF – LEFT – RIGHT.

Positioning the switch at LEFT will trip the left bomb rack when the bomb-rocket release button is depressed. Repeated depression will then trip the right bomb rack. When positioning the switch at RIGHT, the method of employment is similar but opposite with the right bomb rack being tripped on the first depression and the left bomb rack being tripped on a repeated depression. Therefore, it is unnecessary to change the position of the selector switch to sequentially drop bombs on opposite wings. With the switch placed at ALL, both bomb racks are tripped simultaneously. If the selector switch is placed at OFF, the bombs are not released (until emergency release is applied, see below).

If fragmentation bombs (not yet implemented in the simulator) are used, the DEM BOMBS ALL – OFF – LEFT – RIGHT selector switch should be placed at OFF to prevent accidental release of the bombs.

For a rockets + bombs configuration, to prevent a simultaneous release of rockets and bombs when depressing the bomb-rocket release button on the control stick, the following should be verified:

- a) If rockets are to be launched before bombs are dropped, the demolition



bomb sequence selector switch is set to **OFF** and the

rocket release selector switch is set to any position **other than OFF**



b) If bombs are to be dropped before rockets are launched, the demolition



bomb sequence selector switch is set to any position **other**

than OFF and the rocket release selector switch is set to **OFF**.



Bomb-Arming Switch



The Bomb-Arming Switch, used for arming demolition bombs, has two positions: ARM NOSE&TAIL – NEUTRAL – TAIL ONLY. When the switch is placed at the ARM NOSE&TAIL position, both nose and tail fuzes are armed and the bombs will explode instantly upon impact. When the switch is brought to TAIL ONLY, only the tail fuze is armed resulting in delayed detonation. If the switch is set to NEUTRAL, bombs fuzes remain unarmed and bombs impact the ground without detonation.

Fragmentation Bomb Selector Switch



Note. The switch is not yet implemented since no fragmentation bombs exist for the F-86 in the simulation.

The Fragmentation Bomb Selector Switch is used for fragmentation bomb release control. When placed at SINGLE TRAIN, depressing the bomb-rocket release button releases the left bomb first and then the right. When placed at

ALL TRAIN, both bombs are released simultaneously. When placed at OFF, the fragmentation bombs do not detonate.

To enable fragmentation bomb release, the MANUAL RELEASE – AUTO switch should be placed at MANUAL RELEASE.

The Demolition Bomb Sequence Selector Switch is inactive if the Fragmentation Bomb Selector Switch is in a position other than OFF, ie. ALL TRAIN or SINGLE TRAIN.

Bomb-Rocket Release Button

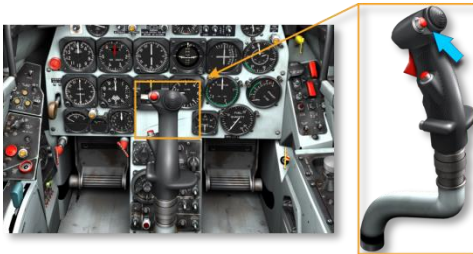

The button closes the release (launch) circuits when depressed. Also, depression of the button operates the gun camera.

Emergency Jettison Handle (Mechanical Jettisoning)



The guarded emergency jettison handle has two distinct release positions and permits selective mechanical release of external loads. Rotating the handle clockwise to a detent stop and then pulling it out as far as possible (about 4 inches) releases only the outboard drop tanks. If the outboard tanks are finless, 200-gallon drop tanks, this jettison procedure additionally causes an explosive charge to fire which forcibly jettisons the tanks. All drop tanks (or all external

loads) are released simultaneously when the handle is pulled, without rotation, to its full extension of approximately 10 inches.

When the cable is pulled, all weapons are disarmed automatically, irrespective of relevant switch positions.

Bomb-Rocket-Tank Jettison Button (Electric Jettisoning)



This button is powered by the battery bus.

It permits a jettison of all stores (except for GAR-8 missiles). Bombs and rockets will be dropped unarmed.

Bombing Controls and A-4 Sight

Use of the above bombing controls enables bomb release (with fuze either armed or unarmed). However, aimed bombing additionally necessitates use of the A-4 sight. To connect the sight to the bombing controls, the gun-missile selector switch must be placed at SIGHT CAMERA&RADAR or GUNS



. Also, the sight selector unit should be placed at



BOMB . Sight adjustment and control is further described in [6.7.1](#).

6.4.4. Low-Altitude Bombing System (LABS)

The low-altitude bombing system (LABS) provides a means for toss-bombing (aircraft starting at low altitude with climb entry under certain G-loads and speeds). Bombs are released automatically at the point calculated by LABS depending on the duration of the G-loads and the current pitch angle. Thus, the aircraft is used for bomb acceleration before release and delivery of the bomb to the auto-trip point (pitch approximately 110°). After release, inertia causes the bomb to continue climbing before it parabolically free falls. Computations ensure that the bomb falls on the same point on the ground that the aircraft was over when the bomb release button was depressed. Originally, LABS was developed for nuclear bombs delivery; however, it can be used for conventional bombs without any limitations.

The primary components of the system are the gyro and relay units installed in the aircraft fuselage. The switch panel of the system is located in the upper right portion of the instrument panel. The instrument that provides dive and roll indications during the bomb run is below the switch panel.

The system is dependent on power from the primary and secondary buses and the single-phase inverter.

LABS Switch Panel



Figure 6.9. LABS Switch Panel

1. LABS Gyro Caging Switch
2. LABS Start Switch
3. Sighting Mode Change Over Switch

(1) LABS GYRO CAGING SWITCH

The switch is located on the left side of the LABS switch panel. It should be placed at UNCAGE during LABS operation and at CAGE when LABS is not being operated.

Note. The switch should be placed at UNCAGE two minutes after LABS is turned on (not simulated). After gyro uncaging, the system indicator indicates current pitch and roll relative to the uncaging point. Therefore, the system should be uncaged only after the aircraft is in as level flight as possible.

(2) LABS START SWITCH

The switch is located in the center of the LABS switch panel. When placed at ON, the A-4 sight reticle is illuminated and the LABS intervalometer motor is energized.

(3) SIGHTING MODE CHANGE OVER SWITCH

The switch is located on the right side of the LABS switch panel. It is used to select the aiming method during bombing: either using the A-4 or LABS.

With the change over switch at A-4, the sight operates normally for gunnery, bomb, and rocket operation. With the switch at LABS, the sight reticle image is electrically caged and the LABS gyro is energized. To turn LABS off, the change over switch should be returned to the A-4 position.

Dive-and-Roll Indicator

The indicator is mounted on the instrument panel below the LABS panel.

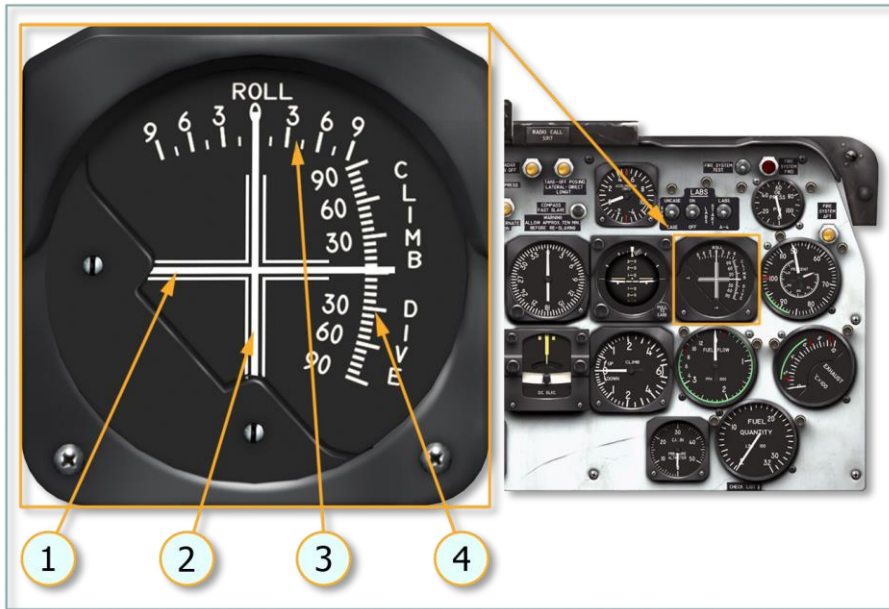

Figure 6.10. Dive-and-Roll Indicator

- | | |
|------------------------------|--------------------------|
| 1. Pitch Deviation Indicator | 3. Roll Deviation Scale |
| 2. Roll Deviation Indicator | 4. Pitch Deviation Scale |

The upper scale indicates roll (tens of degrees) and the right scale indicates pitch (degrees). The indicator is operative after LABS is on, the change over switch is placed at LABS, and the GYRO switch is placed at UNCAGE.

See the section on [LABS bomb employment](#) for a description of proper LABS bomb delivery.

6.4.5. MPC Bombing System

The MPC Bombing System ensures effective and safe bombing by allowing manual control of the sight reticle pip on the reflector as well as providing indication of the proper bomb release altitude and safe break-away point (to avoid collision with the target, terrain, or bomb fragments). This method of aiming and bombing is more accurate and safe (compared with methods not utilizing manual pip control) but is more complicated as well. Proper bomb employment using the MPC and sight can be found [here](#).

The system is comprised of two units in the cockpit: the manual pip control unit and the bombing altimeter. Together, they are used to determine the parameters for a successful bombing run, i.e. airspeed, dive angle, and release altitude. The bombing altimeter additionally allows the aircraft's altitude to be monitored during the attack. For dive angle observation, the attitude indicator is used. For MPC operation, the A-4 sight must be switched to GUN.

Manual Pip Control Unit

The Manual Pip Control Unit electrically controls the A-4 sight reticle and enables the pilot to enter aiming correction manually while bombing. When the switch is in the NORMAL position, the A-4 sight functions normally. When the switch is placed at the BOMB position, the sight reticle is electrically caged at an angle from 0 to 174 mils, depending on the control knob position in the MPC



unit

The MPC unit has four calibrated dials which are used when the attack dive angle and altitude above target are known. One dial is fixed to the face plate,

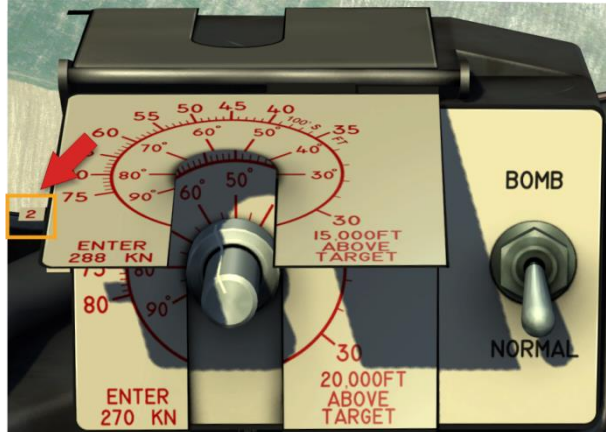

the others foldable

(**Left Mouse Button** and **Right Mouse Button** to scroll through the dials). The appropriate dial is selected based on the starting altitude above target. Once

the proper dial has been selected, the dive angle can be chosen by aligning the



white pointer on the control knob with the angle on the dial's inner scale (DIVE ANGLE) which has a 10° incrementation and ranges from 30° to 90°. Once the dive angle has been chosen, the recommended bomb release altitude (hundreds of feet above sea level) can be determined by reading the value on the outer scale (INDEX ALTITUDE) that lines up with the white pointer



and the chosen dive angle. In the example shown, for a start altitude of 15,000 ft, a dive-entry speed of 288 kts, and a dive angle of 60°, the release altitude is 5,000 ft.

The index altitude and dive angle scales of the MPC unit are calibrated with the following taken into consideration:

- a) Before dive entry, the aircraft is trimmed for level flight, the speed brakes are open, and the throttle is at IDLE.
- b) Dive-entry speed depends upon actual altitude above target (i.e. the difference between instrument altitude and the target's altitude):
 - 10,000 feet – 305 KNOTS
 - 15,000 feet – 288 KNOTS
 - 20,000 feet – 270 KNOTS
- c) Breakaway altitude is calculated based on the aircraft being able to level out at 2,500 feet once 5 Gs of pull-up force are applied after the bomb is dropped.

Bombing Altimeter

The bombing altimeter on the left side of the sight head is connected to the static air source and indicates aircraft pressure altitude.

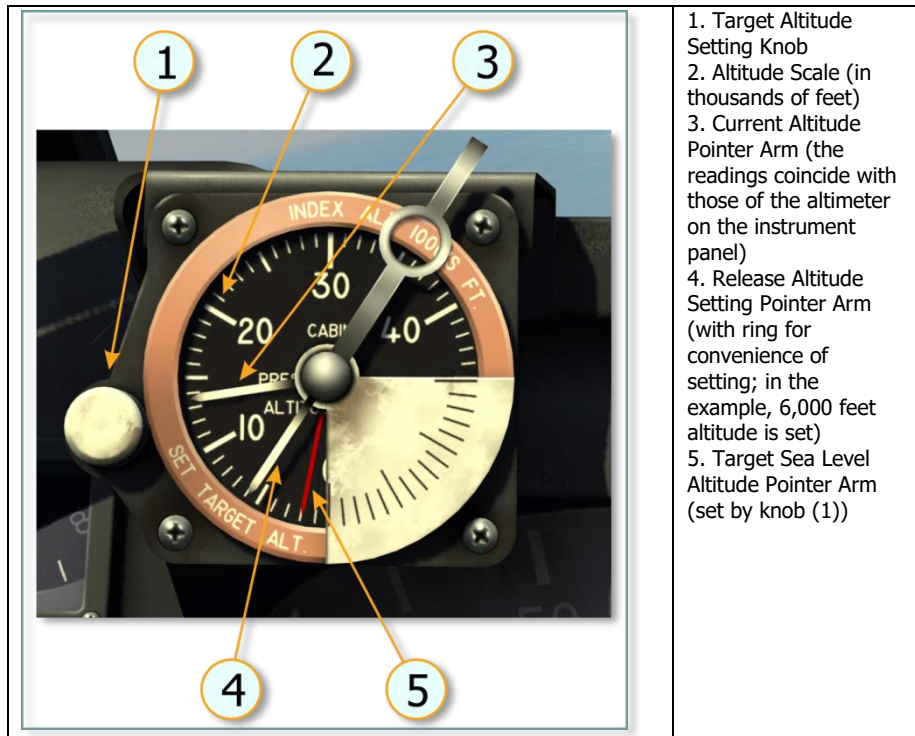

Figure 6.11. Bombing Altimeter

The purpose of this altimeter is to indicate the bomb release and pull-out altitude.

The outer dial is divided into red and white sectors. The white sector contains flight altitude indices while the red sector displays the target altitude, current altitude, and bomb release and pull-out altitude. The target altitude (thin red pointer) is set by the rotary knob on the left side of the unit. This pointer is used to set the target sea level elevation (since the bombing altimeter operates with reference to the sea level pressure). The ringed arm with the white pointer

is used to set the bomb release and pull-out altitude (determined using the value on the MPC panel).

Attitude Indicator

The attitude indicator on the instrument panel indicates the dive angle during bombing, from 10 to 90 degrees. Before bomb-run entry, if the attitude indicator is not aligned to the aircraft, the aircraft should be leveled and the indicator should be caged.

6.5. Rockets and Rocket Systems

6.5.1. General

The aircraft can deploy 5" HVAR's (High Velocity Aircraft Rocket). Eight rocket launchers (four under either half-wing) may be installed to permit the mounting of two rockets on each launcher in two tiers (refer to [6.1.2](#)).



Figure 6.12. Aircraft with sixteen HVAR's

Also, a mixed configuration is possible. For example, two drop tanks may be installed at the outboard stations with four launchers mounted at the inboard stations for carrying eight rockets.



Figure 6.13. Aircraft with eight HVAR's and two drop tanks

For rocket employment, the A-4 sight is used.

For HVAR specifications, refer to [Table 6.3](#).

Table 6.3

	Specifications	
	Weight	134 pounds (61 kg)
	Length	68 in (173 cm)
	Diameter	5 in (127 mm)
	Warhead	7.5 pounds (3.4 kg) of TNT or Composition B
	Warhead weight	45.5 pounds (20.6 kg)
	Engine	52 in (132 cm) long x 5 in (12.7 cm) diameter solid propellant rocket motor
	Wingspan	15.625 in (39.7 cm)
	Propellant	ballistite, extruded
	Speed	1,375 ft per second (419 m/s) plus speed of launching aircraft
	Guidance system	None
	Launch platform	single or twin engine aircraft

A description of proper rocket employment can be found [here](#).

6.5.2. Rocket Controls

The rocket controls are comprised of the following:

- the Rocket Release Selector Switch;
- the Rocket Jettison Switch;
- the Rocket Intervalometer;
- the Rocket Fuze (Arming) Switch;
- the Bomb-Rocket Release Button.

Rocket Release Selector Switch



The Rocket Release Selector Switch has three positions: SINGLE – OFF – AUTO. When the selector is at SINGLE (up), one rocket is fired each time the bomb-rocket release button is depressed on the control stick. When the selector is at AUTO (down), rockets are fired in train while the release button is depressed until all rockets are fired. When the selector is at OFF (center), no rockets can be fired. The rocket release selector switch is inoperative if ROCKETS JETT READY is on (up). In this case, all rockets are jettisoned when the release button is depressed.

Rocket Jettison Switch



In case of emergency, the Rocket Jettison Switch permits all rockets to be jettisoned by means of the bomb-rocket release button.

Rocket Intervalometer

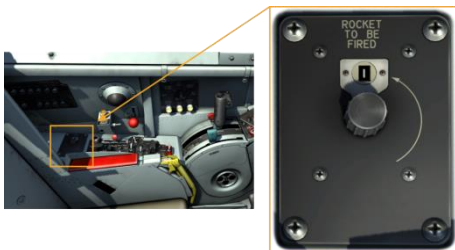

The Rocket Intervalometer allows the pilot to set which rocket should be fired first.



1. The number of the launcher the first rocket is to be fired from
2. Launcher Number Selection Knob

The number of the first rocket to be fired is set using the rotary knob. When the rocket release selector switch is placed at SINGLE, every depression of the

bomb-rocket release button causes a single rocket to be fired starting with the rocket set in the intervalometer. When the selector switch is placed at AUTO, holding the bomb-rocket release button causes the rockets to fire in train in 1/10-second intervals starting with the rocket set in the intervalometer.

If 16 rockets are loaded and the desire is to start firing from the first rocket, '1' (corresponding to the first rocket) should be set in the intervalometer before firing. Therefore, if the rocket release selector switch is placed at AUTO and the bomb-rocket release button is depressed and held, the rockets will start to launch from launcher 1 and will continue until the last rocket is fired, taking approximately 1.5 seconds. If the selector is placed at SINGLE, the rocket from launcher 1 will fire.

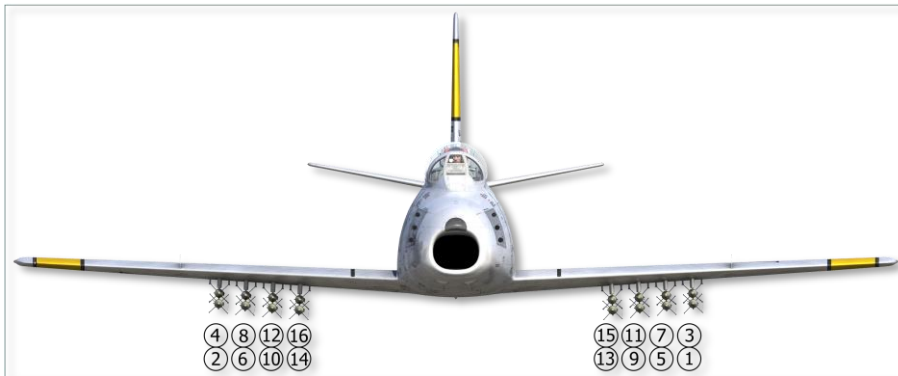

Figure 6.14. Rocket Launching Sequence (16 HVAR's)

If 8 rockets are loaded (for example, if drop tanks are installed), '9' should be set in the intervalometer window since the first rocket will be launched from launcher 9 (drop tanks take the place of stations 1-8).

In the case of a mis-fire or break in the rocket firing sequence, the launcher number selection knob can be used to set another rocket number. For example, if the rocket on launcher 5 failed to launch, another attempt can be made by setting '5' in the intervalometer window.

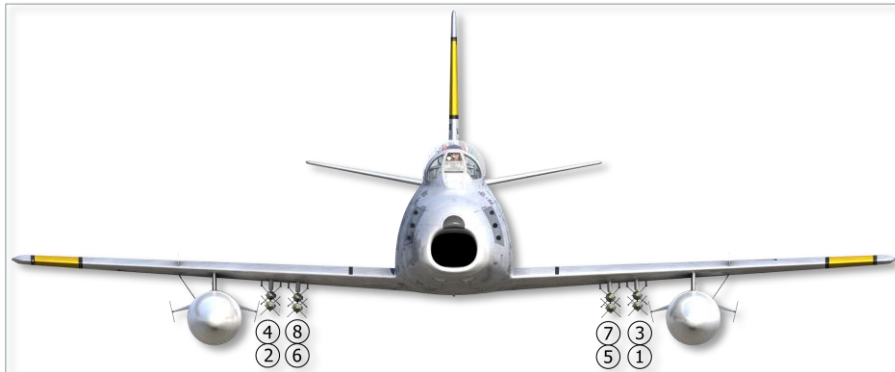

Figure 6.15. Rocket Launching Sequence (8 HVAR's)

Rocket Fuze (Arming) Switch



The Rocket Fuze (Arming) Switch (FUZE DELAY – OFF – INSTANT) allows a rocket detonation delay to be set. When the switch is at INSTANT, the rocket's nose fuze is armed to provide detonation upon impact. When the switch is at DELAY, an internal fuze is armed causing a relatively minor detonation delay after impact. When the switch is placed at OFF, the rocket explodes with internal fuze detonation. If the rockets are jettisoned, their fuzes are unarmed.

Bomb-Rocket Release Button

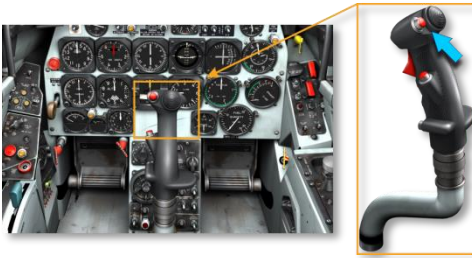

The Bomb-Rocket Release Button closes the release (launch) circuits when depressed. Also, depression of the button operates the gun camera.

6.6. Missiles

6.6.1. General

The aircraft can carry two GAR-8 (AIM-9 prototype) air-to-air missiles with infrared seekers (see [here](#) for a description of proper missile employment).

The missiles can only be installed on the inboard-most stations.



Figure 6.16. Aircraft with GAR-8 Air-to-Air missiles

Drop tanks may be installed alongside the missiles for extended combat air patrol range or duration.



Figure 6.17. Aircraft with GAR-8 Air-to-Air missiles and drop tanks

For specifications of the GAR-8 missile, refer to [Table 6.4](#).

Table 6.4

	Specifications	
	Developed	USA
	Name	GAR-8
	Type	Short-range, infrared, air-to-air missile
	Weight	91 kg
	Length	2.83 m
	Body Diameter	0.127 m
	Warhead	TNT equivalent, kg: 11
	G limit	7
	Speed (Maximum Mach number)	2.5
Range Max	18km	

6.6.2. Missile Controls

The missile controls are comprised of the following:

- the Gun-missile Selector Switch (MISSILE position);
- the Missile Control Panel; and
- the Missile Trigger (missile launch button) on the control stick.

Gun-Missile Selector Switch



The Gun-Missile Selector Switch must be at the MISSILE position before missiles can be launched.

Missile Control Panel

The Missile Control Panel is located to the left of the sight.





1. G Limit Warning Light – indicates missile launch G limit exceeded
2. Missile Control Switch:
LH&RH – left missile will be launched first, then right missile;
RH – right missile will be launched first, then left missile;
SALVO – both missiles will be launched in salvo
3. SAFE LAUNCH – launches both missiles unguided
4. TONE VOLUME – controls the volume of the missile's search / target lock-on audio signal

Control Stick Missile Trigger (Missile Launch Button)

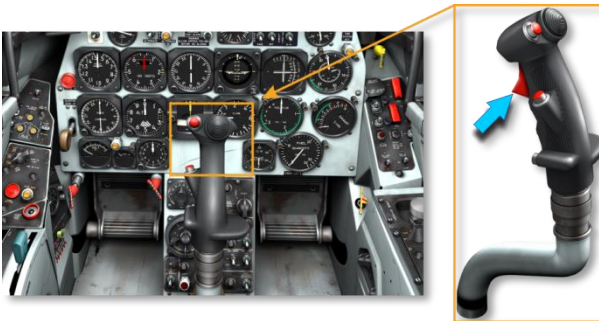

The Control Stick Missile Trigger is used to actually launch the missiles once the controls are properly configured.

6.7. A-4 Type Semi-Automatic Telescopic Sight

The A-4 sight is used for aiming when firing guns, bombing, launching rockets, or firing missiles. The sight includes a ballistics computer (resolver) designed to facilitate aiming (although aiming can also be done manually). A gyro built into the sight is used to determine the aircraft's turning rate which is then fed into the computer.

In addition to the ballistics computer, the sight automatically connects to one of the armament subsystems depending on the type of weapon selected on the sight selector unit (see below).

The sight reticle image consists of a center dot inside a circle of ten equally



spaced diamond-shaped dots (or *diamonds*). The image of these diamonds is projected onto the sight's reflector glass, and can move across the glass depending on the weapon used and the sight operation mode.

The components of the sight are shown in [Figure 6.18](#).

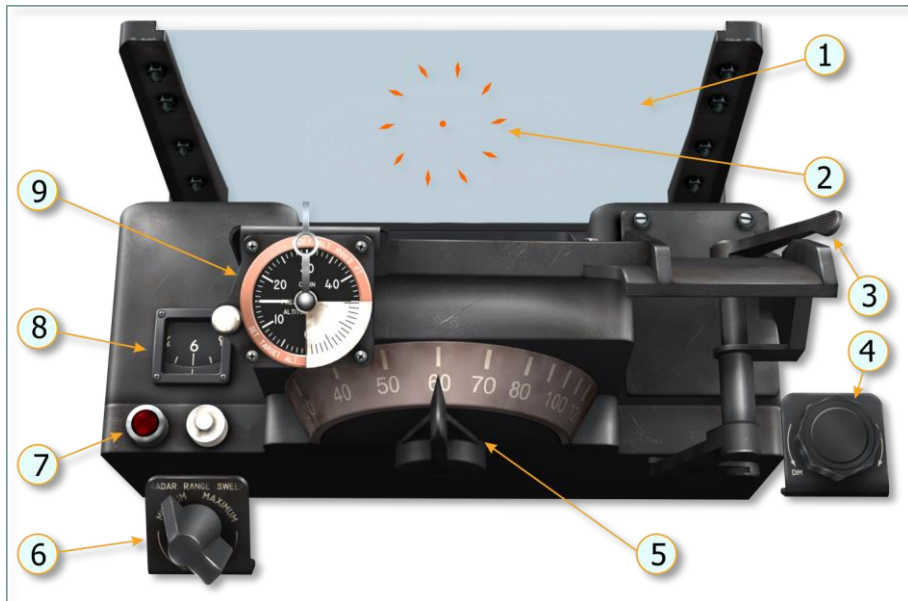

Figure 6.18. A-4 Sight

- | | |
|--------------------------------------|--|
| 1. Reflector Glass | 6. Radar Range Sweep Rheostat Knob |
| 2. Sight Reticle Image | 7. Radar Target Indicator Light |
| 3. Sight Mechanical Caging Lever | 8. Sight Range Dial |
| 4. Sight Reticle Dimmer Control Knob | 9. Bombing Altimeter (mounted on the sight for convenient viewing) |
| 5. Wing Span Adjustment Knob | |

(1) *REFLECTOR GLASS* allows the reticle image to be displayed in the pilot's forward view.

(2) *SIGHT RETICLE IMAGE* allows the pilot to put the aircraft in the proper attack position by superimposing the reticle image over the target (only applies when the computer is used, see below). By superimposing the reticle image over the target, the pilot is compensating for the target's speed, direction, and offset from the weapon axis.



(3) *SIGHT MECHANICAL CAGING LEVER* allows the pilot to mechanically cage the sight gyro to prevent its damage when the aircraft is on the ground (whether moving or not). The caging lever can also be used in case of gyro failure.

UNCAGE position: This allows normal, automatic operation of the sight.

CAGE position: This mechanically stabilizes the sight gyro. This position should be used for ground attacks or in the case of sight gyro or computer failure. Even with the gyro is caged, the reticle size can be adjusted manually based on the target's wing span (see below).

Caution! When taxiing, taking off, and landing, the lever should be set to CAGE to prevent sight damage.



(4) *SIGHT RETICLE DIMMER CONTROL KNOB* is used to regulate the brightness of the sight reticle. The knob should be placed to DIM when the sight is not in use to prevent damage to the reticle bulb in the event of voltage surges.

(5) *WING SPAN ADJUSTMENT KNOB* is used to set the wing span of the target



aircraft which is based on the aircraft type.

To decrease the wing span, press [V].

To increase the wing span, press [N].

The adjustment knob allows the target's wing span to be manually entered into the sight. The wing span may be from 30 to 120 feet and is used to calculate range to the target as well as optimal firing range.



(6) *RADAR RANGE SWEEP RHEOSTAT KNOB* is used to change the radar output power, thus decreasing or increasing target detection range.

MAXIMUM is the normal position at the start of an attack. It is recommended that the power be reduced during low altitude operations to prevent the radar from locking on to the ground or ground objects.

Radar ranging should be off when the aircraft is on the ground.



(7) *RADAR TARGET INDICATOR LIGHT* comes on when the radar ranging equipment has locked on to the target and has started tracking it. The light's brightness can be adjusted.



(8) *SIGHT RANGE DIAL* is used to indicate the target's range in hundreds of feet as determined by range data supplied either by the radar or through manual entry by the pilot (if the sight is operating in manual mode). The dial is graduated in 100-foot intervals covering a span from 600 to 6,000 feet.



(9) *BOMBING ALTIMETER* is a part of the bombing system. It is fitted on to the sight for easy access and reference. For more details, refer to the [Bombing Altimeter](#) section.

6.7.1. Sight Adjustment and Control Equipment

Radar Target Selector Button



After detecting a target, the radar locks on to it and starts measuring the range to the locked target. To override the radar lock-on and to shift the radar to another target (if there is more than one target), the pilot needs to momentarily depress and release the radar target selector button on the control stick [\[Enter\]](#). The radar will then reject the previously locked target, automatically recycle, and begin to sweep for another target starting from the minimum sweep range. This allows a re-lock on the closest (most critical) target while the sight automatically switches to GUN mode (connects to the gunnery subsystem).

Sight Electrical Caging Button

The sight is caged electrically when the caging button on the throttle is held



depressed [].

This results in the sight reticle image being stabilized. Image stabilization is necessary to limit gyro deflection as the result of maneuvering on the initial approach to the target. Unlike the sight mechanical caging lever, the button on the throttle allows the pilot to keep hands on the controls which is especially important in a maneuvering battle. This also makes the sight combat-ready (it starts working together with the computer) immediately after the button is released.

Manual Ranging Control



A twist grip is incorporated into the throttle which allows manual target ranging. This is useful if the gun sight's automatic function fails or if target engagement occurs at altitudes below 6,000 feet where radar ranging becomes erratic because of ground effects.

The manual range control covers a span from 1,200 feet to 2,700 feet.

Clockwise rotation of the twist grip increases reticle diameter (reduces the range) while counterclockwise rotation decreases reticle diameter (increases the range).

To decrease manual range, press [\[.\]](#).

To increase manual range, press [\[;\]](#).

N o t e . To achieve maximum detection range when using the radar in conjunction with the [Radar Ranging Unit](#), it is necessary to rotate the twist-grip fully counter-clockwise [\[;\]](#)



until it stops (maximum range).

Sight Selector Unit

The sight selector unit is used to connect the sight to one of the weapon subsystems (rockets, guns, or bombs), to set the rocket sight angle, and to select the air target speed. For those purposes, the unit has three independent switches (see [Figure 6.19](#)).

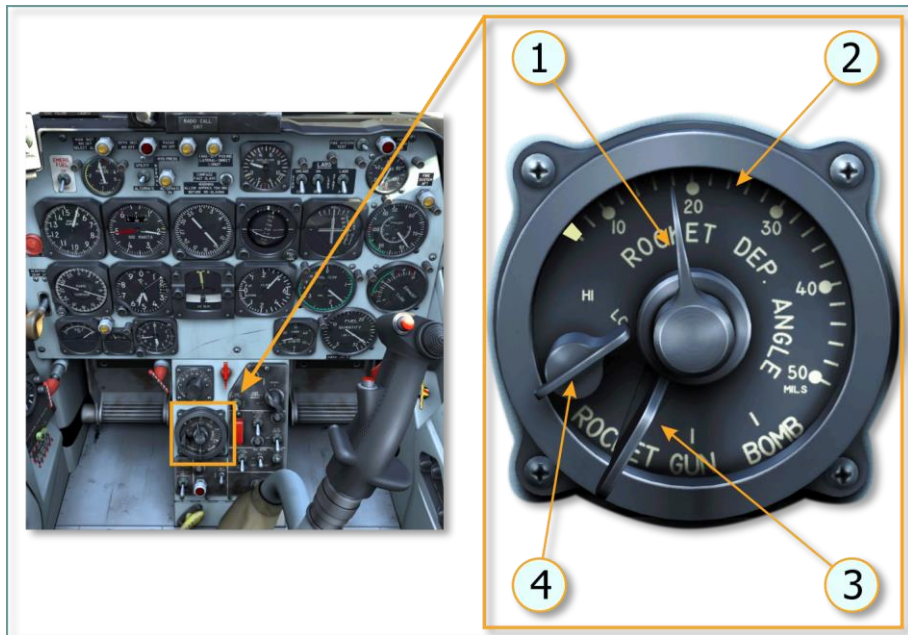

Figure 6.19. Sight Selector Unit

- | | |
|--|----------------------------------|
| 1. Rocket Setting Lever | 3. Sight Function Selector Lever |
| 2. Rocket Sight Angle Setting Scale (in
mils, 1/6400 of a circle in NATO countries) | 4. Target Speed Switch |

(1) *ROCKET SETTING LEVER* is used to set a drop (depression) angle for a rocket which depends on the firing range, the aircraft's dive angle, and the weight of the rocket (the angle value for different configurations has been determined through test firing runs). It should be noted that the shallower the dive angle or the higher the range, the poorer the accuracy of the rockets. Changing the angle with the rocket setting lever causes the sight reticle image to move along the vertical axis. This allows the pilot to correct for the effect of gravity on the rocket. The angle should be increased when either rocket range needs to be increased, dive angle needs to be reduced, or the weight of the rocket has increased. When the angle is increased, the sight reticle image moves downward. Therefore, the nose of the aircraft must be raised to put the depressed reticle image over the target. This increases the firing elevation in the vertical plane causing the rockets to fly farther.

For example, for 5" HVARs with a dive angle between 0° and 40°, the normal depression angle correction would be 17 mils.

(2) *ROCKET SETTING SCALE* is calibrated in mils (1/6400 of a circle in NATO countries).

(3) *SIGHT FUNCTION SELECTOR LEVER* can be set to either ROCKET, BOMB, or GUN and affects how the reticle image moves due to the ballistic trajectory of rockets, bombs, or guns respectively.

(4) *TARGET SPEED SWITCH* should be set to LO when the speed of the target is lower than that of your aircraft and set to HI when the speed of your aircraft and the target are approximately the same.

Bomb-Target Wind Control Knob (no function in the simulation)

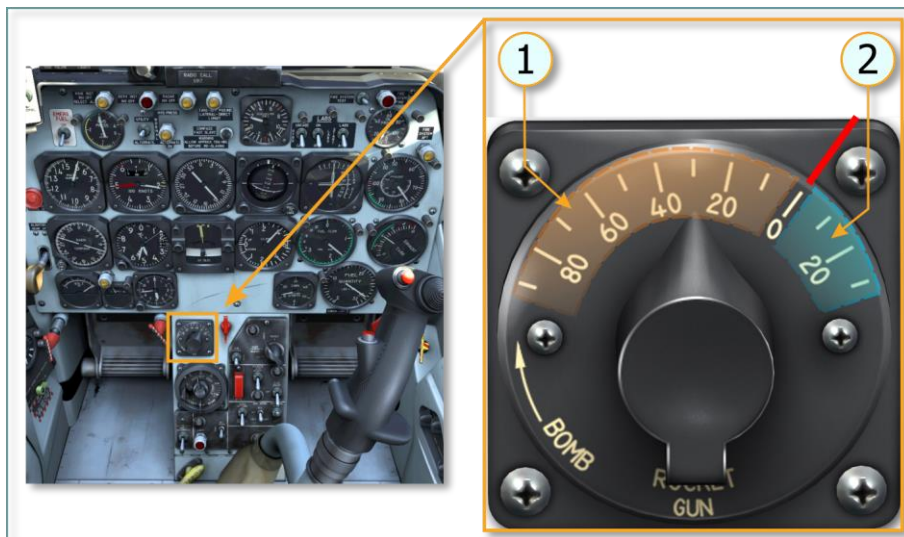

Figure 6.20. Wind Control Knob

1. UPWIND scale – used to enter headwind speed or receding target speed

2. DOWNWIND scale – used to enter tailwind speed or approaching target speed

Note. Colored elements in the diagram are not present in the actual instrument.

The control is used to compensate for wind and target speed during aiming when bombing. The wind (target) speed scale is marked in knots.

Corrections for wind are entered as follows (a similar approach is used for target speed):

- 1) In case of a headwind, use scale (1). Set average wind velocity based on a known value in knots (10 knots approximately equals 18 km/h).
- 2) In case of a tailwind, use scale (2). Set average wind velocity in knots based on a known value.
- 3) If the wind direction is 90° to the attack course of the aircraft, set 0 knots for wind velocity.
- 4) If the wind direction is other than 90° to the attack course of the aircraft, set a value proportional to the tailwind component or headwind component relatively to the aircraft's course.

6.7.2. Sight Operation Modes

The sight can be used without the computer (manual mode) or with the computer.

The two modes are reviewed below for gunnery use cases.

Using the Sight Without the Computer

WHEN USED WITHOUT THE COMPUTER, the sight reticle image remains still (almost aligns with the axis of the weapon) and the pilot therefore has to manually solve the aiming task (i.e. determine the required offset of the weapon center line relative to the target) by visual estimation:

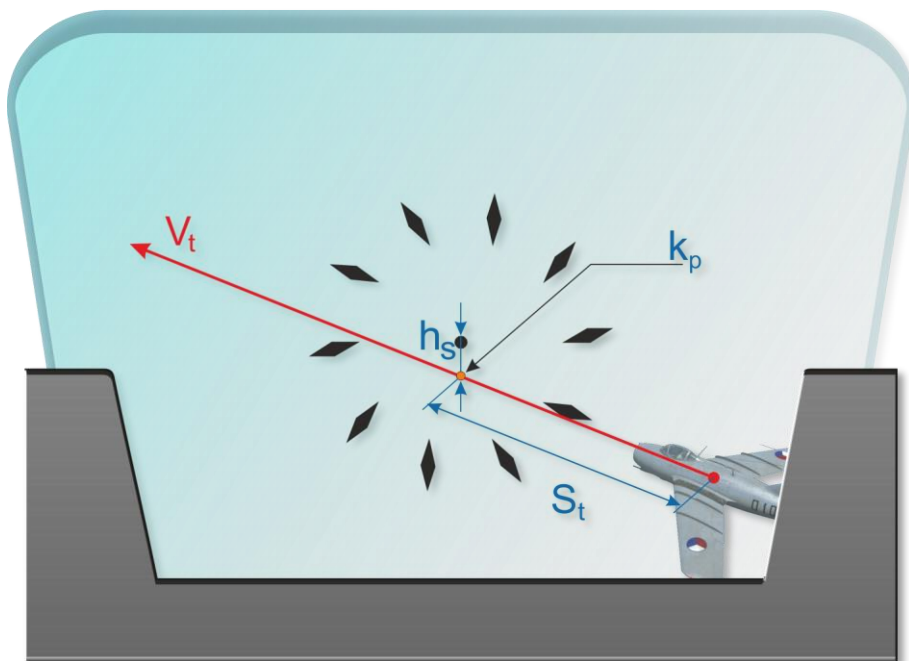

**Figure 6.21. Diagram of Aiming Without Computer
(sight reticle image is still)**

V_t – target's velocity vector
 h_s – approximation of shell's drop
 (depression) during flight to target

S_t – target's path to impact point with shell
 k_p – estimated impact point

It is recommended that the sight be used without the computer during close-proximity combat or when engaging a highly maneuvering target. A rather high hit probability exists for target ranges within 100 m (300 ft). As range decreases, drop (depression) h_s becomes less significant and may be ignored.

Using the Sight with the Computer

USE OF THE COMPUTER significantly improves firing efficiency as it allows the pilot to far more accurately take into account target velocity, depression of projectiles (bullets, rockets), target range, and air density as compared to when the sight is used without the computer.

Angular velocity of the target is determined based on gyro precession as the pilot tries to keep the target in the center of the sight. Air density data is determined automatically via the altitude sensing unit. Target range can be calculated automatically using the AN/APG-30 radar ranging unit or manually entered by the pilot (based on the target's known wing span and angular measure). Manual range input requires the target to be continuously enclosed by the diamond-shaped dots of the sight reticle through use of the knob on the throttle grip. If the target's wing span (b_t) (linear size) is known, the computer calculates the range (D_t) based on the following function:

$$D_t = \frac{b_t}{2\text{tg}(0.5\psi_t)}$$

where b_t is the target's wing span, i.e. linear size (for the F-86 computer) for 3/4 aspect; and

ψ_t is the angular spacing between the inner corners of the diamond-shaped dots.

For example, an object with an end-to-end span of 100 m will occupy 100 mils of a radian at a 1,000 m distance.

The Manual Ranging Control is a twist grip on the throttle that allows manual ranging during gunnery operations when the automatic function of the gun sight fails or when radar ranging becomes erratic because of ground effects (at altitudes below 6,000 feet when over land). The manual range control covers a span of 1,500 feet, from approximately 1,200 feet to 2,700 feet, as indicated on the sight range dial. Clockwise rotation of the twist grip reduces the range (increases reticle diameter) whereas counter-clockwise rotation increases the range (decreases reticle diameter). In the real aircraft, the control is spring-loaded to the full counter-clockwise position where it must be for radar ranging to be optimally effective.

PRINCIPALS OF AIMING

When using the sight in combat with the computer on, the pilot will observe both the target and the ranging ring through the sight head collimator system reflector. The ranging ring is formed by a center dot as well as ten diamond-



shaped dots: . The ranging ring changes diameter when the manual ranging control fitted on the throttle grip is twisted.

When chasing the enemy, the pilot's job is to maneuver the aircraft so that the center dot is superimposed on the target. Moreover, the pilot must continuously enclose the target within the ranging circle (diamond-shaped dots).

Relative angular velocity of the target is automatically measured and passed to the sight's computer (resolver) via the attitude gyro which determines gyroscopic precession as the target is tracked within the ranging circle.

Precession rate is changed by the pilot through the range rheostat which is



incorporated into the throttle as a twist grip which can be rotated using the keyboard or joystick only. The twist grip changes the parameters of the range rheostat which, in turn, affect the gyro precession rate. The gyro axis glass, which projects the sight reticle image, deflects to a smaller or greater angle depending on the gyro's operation parameters. If the aircraft is in a turn with the target when the gyro is uncaged, the sight reticle image will lag behind the target so that the pilot has to 'move' the X-axis of the aircraft (and the guns) ahead of the target along its velocity vector in order to maintain the reticle image circle on the target. The aiming point offset depends on the above factors.

The diagram in [Figure 6.22](#) illustrates particular aspects of aiming with the gyro sight:

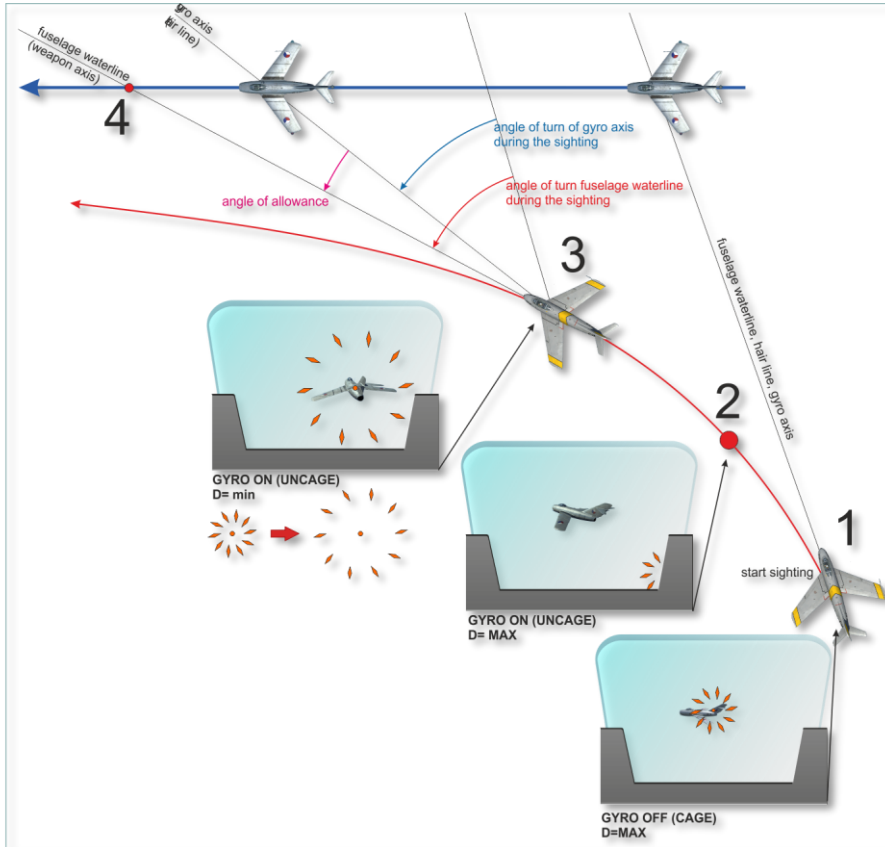

Figure 6.22. Aiming with Gyro Sight

Point 1. At entry to the attack, the gyro is caged with the pilot observing the target through the center dot of the sight. "Range" is set to 2,500 ft, for example.

Point 2. The pilot has uncaged the sight's gyro and is turning the aircraft to keep the target in the field of vision. Since the aircraft's angular velocity is now a factor, the gyro precession causes the sight reticle image to lag behind the target. For the set range of 2,500 ft, the sight's computer has applied a maximum correction, forcing the sight image nearly outside the field of vision.

Point 3. The pilot has closed in on the target and, hence, has reduced the range on the rheostat to the minimum. This results in the spacing between the diamond-shaped dots to be larger and also causes the sight reticle image to move closer to the center of the sight due to the decreased angular correction. Therefore, the pilot has an easier time keeping the target inside the circle of diamond-shaped dots. When the target is located precisely in the center of the circle, the aiming angle (the angle between the aircraft's axis and the gyro axis pointing to the target) has been established.

Point 4. Any projectiles (bullets) that have been fired impact the target.

6.8. AN/APG-30 Radar Ranging Unit

Approximate range of the AN/APG-30 radar ranging unit is from 450 to 9,000 feet.

The AN/APG-30 automatically locks on and tracks the target, indicating its

range  in thousands of feet:

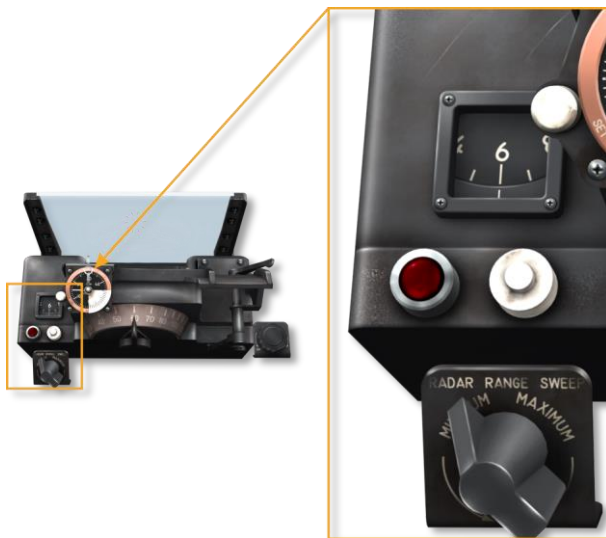

When attacking targets at 6,000 feet and below, the radar operation is unstable due to ground effects. In these cases, the optimal target range can be set manually.

The radar equipment is operative when the Gun-Missile Selector Switch



is set to any position other than OFF.

Note. When operating the Radar Ranging Unit with the A-4 Sight, the twist grip on the throttle



should be turned fully counter-clockwise (using the **[F]** key) to allow a maximum radar detection range.

6.9. Gun Camera

The gun camera is mounted in the lower portion of the intake duct. To operate the gun camera without firing guns, rockets, or missiles, the gun safety switch



(gun-missile selector switch) must be positioned at SIGHT&CAMERA RADAR. Pressing the trigger to the first detent operates the gun camera which will continue to operate as long as the trigger is pressed for a maximum of 10 seconds. The gun camera also functions with the firing of guns, rockets, or missiles.

The main parameters of the Gun camera are listed in Table 6.5.

Table 6.5

Parameter	Value
Number of frames in cartridge	150
Maximum photoshooting time	19

Photoshooting rate, frames/sec	7-10
--------------------------------	------

In the simulation, the gun camera recordings can either be seen during the game or afterwards in the track replay. This can be configured in the game settings with the three different options under GUN CAMERA MODE:



- OFF – disabled, gun camera recordings are not shown;
- ONLY FOR TRACKS – recordings will be shown only during track replay;
- ON – recordings will be shown immediately during weapon firing (Warning: may cause stuttering on low-end hardware!).

Every time one of the gun triggers is pressed, a photo taken by the gun camera will be displayed (Figure 6.23):











Figure 6.23. Photo taken by the gun camera

6.10. Weapon Related Cockpit Objects

(Sight, then left to right)

	<p>1. A-4 sight. Operates with all weapon subsystems.</p>
	<p>2. Rocket intervalometer. Rocket subsystem element that sets the number of the first rocket to be launched.</p>
	<p>3. Throttle twist grip. For manual ranging (correction of sight computer input data).</p>

		<p>4. Throttle sight gyro electrical caging button. For easy-access gyro caging.</p>
		<p>5. Guns control panel. Gunnery subsystem element for selecting which guns are to be fired.</p>
		<p>6. Manual pip control unit. Element of bombing subsystem, manual pip control system.</p>
		<p>7. Missile control panel. Element of missile subsystem.</p>

		<p>8. Bombing altimeter. Element of bombing subsystem, manual pip control system.</p>
		<p>9. Switch panel for low-altitude bombing system. Element of bombing subsystem, LABS.</p>
		<p>10. LABS attitude indicator. Element of bombing subsystem, LABS.</p>
		<p>11. Weapons control center pedestal. Switches and selectors for control of weapons and sight.</p>

		<p>12. Stores jettison button. Element of release control subsystem. For emergency electrical release of bombs/rockets/tanks from racks.</p>
		<p>13. Emergency jettison handle. Element of release control subsystem. For emergency mechanical release of bombs/rockets/tanks from racks.</p>
		<p>14. Control stick trigger. For firing guns and launching missiles.</p>
		<p>15. Control stick release button. For launching rockets and dropping bombs.</p>
		<p>16. Control stick target selector button. For rejecting/shifting radar targets.</p>

SCHEMA POSIZIONE ANTENA RADIO E RADAR

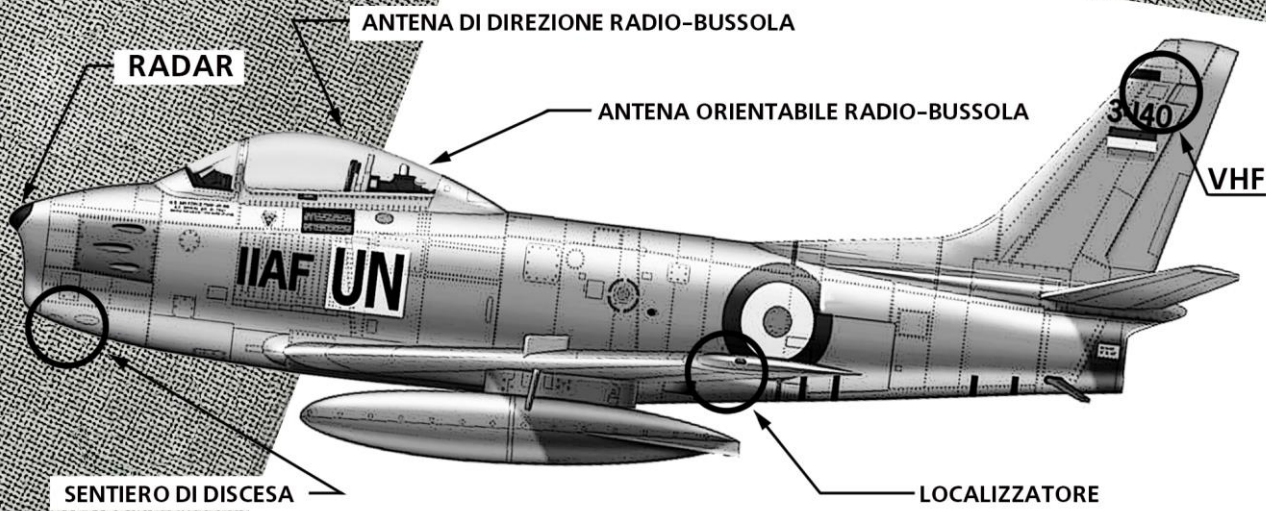

7. RADIO COMMUNICATION AND RADIO ELECTRONIC EQUIPMENT

7.1. UHF Command Radio — AN/ARC-27

The AN/ARC-27 provides two-way voice communication in the frequency range of 255 to 339.9 MHz between aircraft and between aircraft and ground stations.

The control panel on the right console contains three control devices (refer to [Figure 7.1](#)):



Figure 7.1. UHF Command Radio — AN/ARC-27

1. Power Switch
2. Channel Selector
3. Audio Volume Control

(1) *POWER SWITCH* (OFF–T/R–T/R+G REC–ADF) energizes the radio set and allows mode selection: OFF for deactivated; T/R for one receiver; T/R+G REC for two receivers; and ADF (not implemented);

(2) *CHANNEL SELECTOR* allows the selection of any of the 18 preset channels. The channels may be customized in the Mission Editor on the radio channels tab:



Figure 7.2. Customizing AN/ARC-27 Channels in Mission Editor

(3) *AUDIO VOLUME CONTROL* allows volume level to be adjusted.

The radio set is powered by the primary bus.

Operation of AN/ARC-27 Command Radio

1. Move power switch to T/R or T/R+G REC.
2. Move preset channel selector to desired channel.
3. Adjust volume control for desired audio volume.
4. To transmit, press microphone button on throttle.
5. To unpower the radio, rotate the power switch to OFF.

7.2. Radio Compass (ADF) AN/ARN-6

This navigational aid has an indicator on the instrument panel



and a control panel on the right console (refer to [Figure 7.3](#)). Controls enable either automatic or manual direction finding.

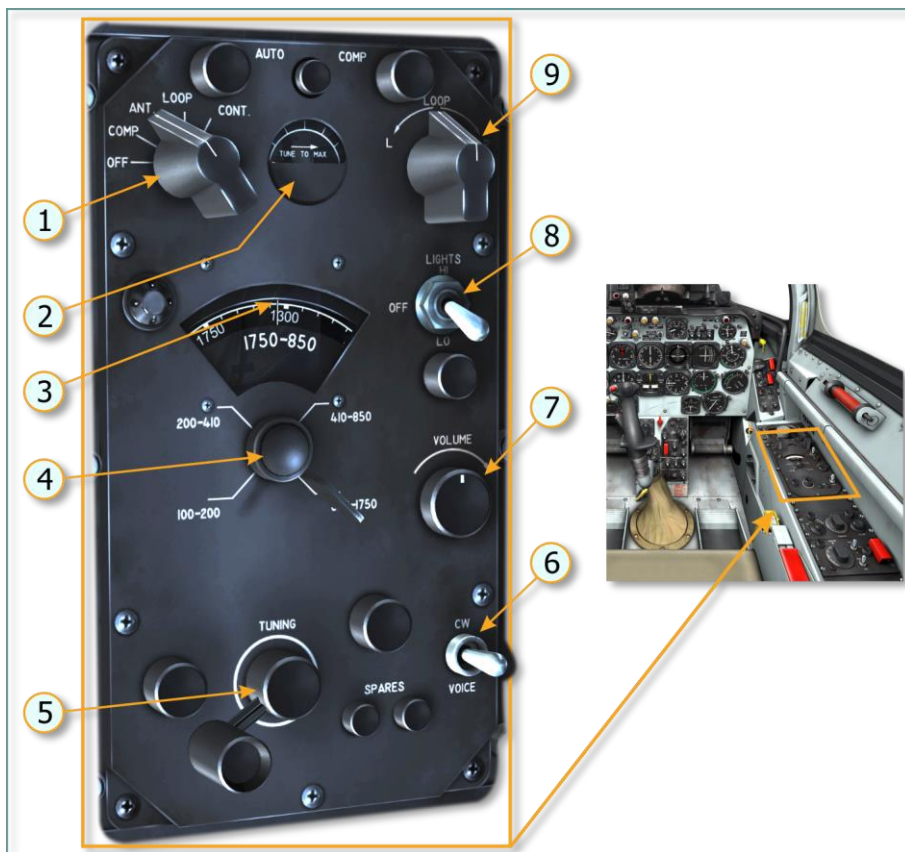

Figure 7.3. Radio Compass AN/ARN-6

- | | |
|-------------------------------|---------------------------------|
| 1. Function Selector Switch | 6. CW-Voice Oscillator Switch |
| 2. Tuning Meter | 7. Volume Control |
| 3. Band and Frequency Display | 8. Display Light Control Switch |
| 4. Band Switch | 9. Loop Rotation Switch |
| 5. Tuning Control | |

(1) *FUNCTION SELECTOR SWITCH* (OFF–COMP–ANT–LOOP–CONT) allows the radio compass mode to be selected. OFF turns the unit off. COMP puts the unit in compass mode (primary mode of use). ANT puts the unit in antenna sensing mode (for fine frequency tuning). LOOP puts the unit in loop mode (for loop antenna functional test). CONT is not implemented;

- (2) *TUNING METER* displays signal strength (useful for fine tuning);
- (3) *BAND AND FREQUENCY DISPLAY* shows the current band and frequency that the radio is operating in. There are four pre-selected frequency bands:
- from 100 to 200 kHz;
 - from 200 to 410 kHz;
 - from 410 to 850 kHz;
 - from 850 to 1750 kHz.

The current finely-tuned frequency can be read under the vertical line on the



- (4) *BAND SWITCH* toggles the bands which are indicated on the display (3);
- (5) *TUNING SWITCH* permits fine tuning of frequency. It is recommended that the player monitors the frequency strength on the tuning meter (2) in addition to listening to the audio quality of the signal;
- (6) *CW-VOICE OSCILLATOR SWITCH* not simulated;
- (7) *VOLUME CONTROL* is a rheostat that allows signal volume adjustment in the pilot's headset;
- (8) *DISPLAY LIGHT CONTROL SWITCH* (HI-OFF-LO) controls the brightness of the back light on the tuning meter and the band and frequency display. HI sets a high brightness. LO sets a low brightness. OFF turns the lights off;
- (9) *LOOP ROTATION SWITCH* (LOOP L-R) allows the loop antenna to be manually rotated to the left (L) or right (R) when LOOP function is selected. This, in turn, causes the needle on the compass to turn clockwise or counter-clockwise. Once the loop antenna has been adjusted and the frequency is correct, an aural signal will be heard and a strong reading will appear on the tuning meter. Also, the compass will show the correct bearing to the radio station.

The radio compass is powered by secondary bus.

Operation of RADIO COMPASS AN/ARN-6

1. Place the Function Selector Switch to the desired position.
2. Place the Band Switch to the desired band.

3. Rotate the Volume Control to maximum (to the right).
4. Use the Tuning Switch to tune in the desired station.
5. In case of an antenna sensing failure, set the Function Selector Switch to LOOP and turn the loop antenna using the LOOP L-R Switch until a MINIMUM level aural signal can be heard and a reading appears on the Tuning Meter (2).
6. To deactivate the radio compass, rotate the Function Selector Switch to OFF.



8

**FLIGHT AND RELATED
PROCEDURES**

8. FLIGHT AND RELATED PROCEDURES

Below is the successive description of main procedures, beginning with engine preparation and start up and continuing through to engine shutdown after flight. Optional procedures (i.e. those not mandatory for each flight) are marked with an asterisk (*).

8.1. Starting the Engine

Engine shall be started from the ground power unit only (due to high power consumption by the starter).

Preparation before engine start-up

1. Connect the ground power:

[N] (Radio Menu), [F8], [F2], [F1] (Connect Ground Electric Power).

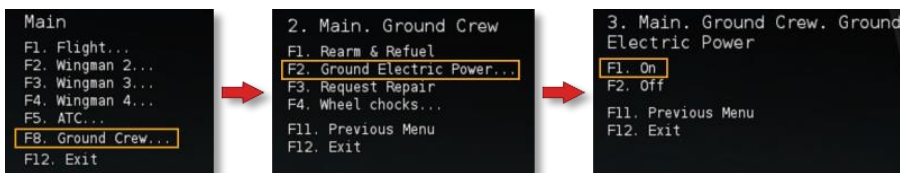

[N]

[F8]

[F2], [F1]

Make sure the power supply is on by checking that the ALTERNATE lamp comes on (see below).

2*. After ground power is connected and before the engine is started, check the pressure in the alternate hydraulic system (redundant flight control boost system) - done by setting the pressure gauge selector switch to ALTERNATE.



When the external power unit is connected, the plunger pump for the alternate flight control boost system will start. Pressure in the system should rise to the operating pressure (approximately 3000 PSI).

Once the engine has started, set the selector switch to NORMAL and check the pressure in the normal flight control boost system.

Warning. Prior to starting the engine, make sure that the landing gear control lever is in the EXTENDED position (down).

Note. To start the engine, a series of operations with the throttle control and selector switches must be performed. It should be kept in mind that during start-up, engine parameters can change quickly and non-linearly (e.g. it will take a few seconds for the compressor to reach 3% rpm, while 3% rpm will change to 6% rpm within one second) so, it is recommended that you first become well familiarized with the entire start-up process before attempting to start the engine.

Start-up operation

1. Set throttle control to OFF (default setting) **[End]**

Note. Throttle control can be only moved to the rearmost position (OFF) and from the OFF position to



the IDLE position using the keyboard **[End]** \ **[Home]**.

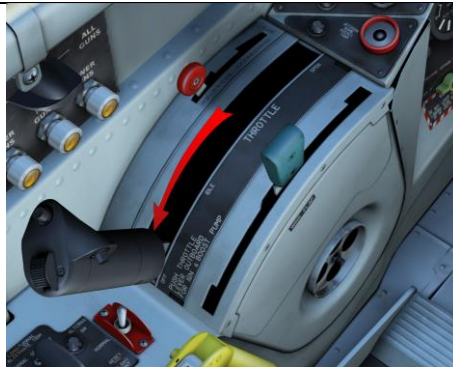

2. Set ENGINE MASTER switch to ON **[RAIt + RShift + E]**



3. Set BATTERY-OFF-STARTER selector switch to STARTER (1) [RAIt + RShift + N] (briefly), then to BATTERY (2) [RAIt + RShift + H]



Warning

1. If voltage drops below 15 V during start-up, immediately abort the operation by pressing the STOP-STARTER button in order to prevent damage to the generator starter relay.
2. The starter is limited to three starts during any 30-minute period. After three starts, allow the starter to cool for 30 minutes.

4. At 3% engine rpm, set throttle control to THROTTLE OUTBOARD position (between IDLE and OFF) by pressing [Home] once. This will engage the fuel booster pumps and energize the ignition system.

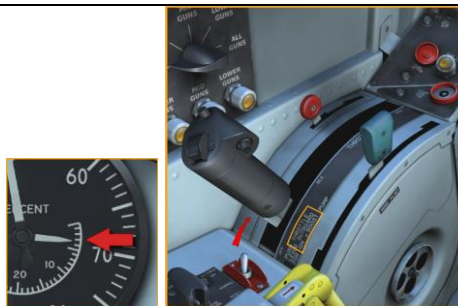

5. At 6% engine rpm, move throttle control to IDLE by pressing [Home] a second time.



Note. Once the throttle control is moved to IDLE, the starting process will continue without the pilot's involvement.

During start-up, the pilot needs to check and verify the following:

- exhaust gas temperature increases (according to temperature gauge readings);
- fuel consumption does not exceed 500 – 800 pounds per hour (according to the fuel flow meter);
- when the throttle is in IDLE, temperature is within 600 - 690°C;
- generator operates correctly (generator's warning light is out).



Warning

1. If temperature fails to increase within 5 seconds, depress the STOP-STARTER button to shut down the ignition system.
2. If engine speed does not reach 23% within 1 minute, abort the start.
3. Use of the STOP-STARTER button during normal engine start can cause failure of the ignition system.
4. Another attempt to start will be possible after 3 minutes.

Warning

The following conditions constitute overtemperature operation:

- a) *DURING ENGINE START-UP TO IDLE RPM (WITHIN 2 MINUTES):* 950°C or above for 2 seconds or more.
- b) *ALL ENGINE OPERATION EXCEPT FOR START-UP:*
 - 690°C to 750°C for 40 seconds or more;
 - 750°C to 800°C for 10 seconds or more;
 - 800°C or above for 2 seconds or more.

Note. Military Thrust is defined as the thrust obtained at full open throttle (100% engine rpm or 690°C exhaust temperature, whichever is lower) and is limited to 30 minutes.

8. Once the engine has started, ground power should be disconnected.

[N] (radio menu), [F8], [F2], [F2] (disconnect power):

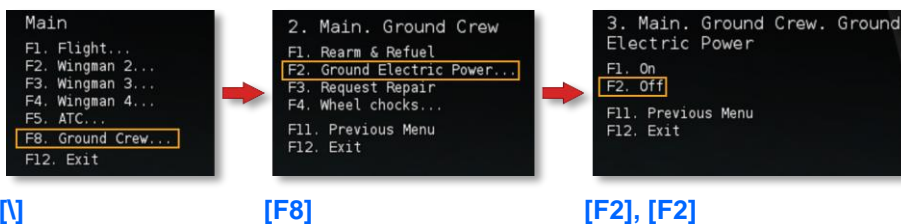

8.2. Systems check after start-up

Ground Operation

No engine warm-up is necessary.

Once the engine stabilizes at idling speed, the gauge readings should be as follows:

- an rpm of 30 – 38 % depending on airport altitude and outside air temperature;
- a turbine exhaust temperature between 600 — 690°C.

The engine can run within the entire operating range up to the maximum rating.

Note. The engine has a poor acceleration rate between IDLE and 63% rpm.

System Ground Checks After Engine Start-up

If, prior to start-up, the hydraulic pressure gauge selector switch remains at ALTERNATE, the gauge will show pressure in the alternate boost system during start-up.

1. Normal and Alternate flight control hydraulic system check

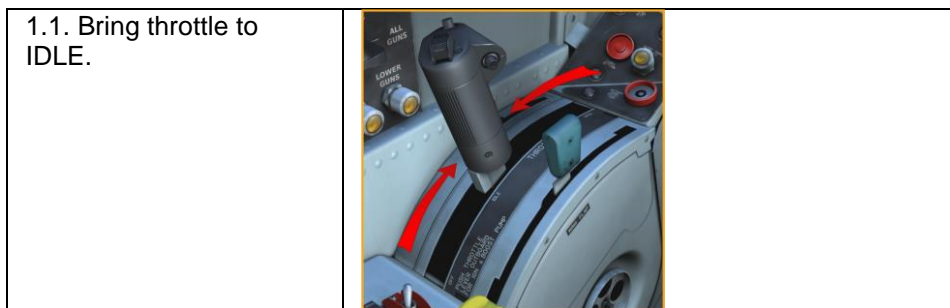

<p>1.2. Set hydraulic pressure gauge selector switch to NORMAL.</p>	
<p>1.3. Set Flight Control switch to RESET (make sure that alternate-on warning light is out) then set the switch to NORMAL.</p>	
<p>1.4. Move the control stick in all directions and visually check for proper control surface movement. Once the control stick is brought to the neutral position, the pressure should be between 2750-3200 PSI.</p>	
<p>1.5. Check the alternate flight control hydraulic system after moving the Flight Control switch to ALTERNATE ON and bringing hydraulic pressure gauge selector switch to ALTERNATE.</p>	
<p>1.6. Once normal and alternate flight control systems checks are completed, bring the FLIGHT CONTROL</p>	

switch to NORMAL after setting it briefly to RESET.

2. Utility hydraulic system check

2.1. Set the hydraulic pressure gauge selector switch to UTILITY.



2.2. Extend and retract speed brakes [B].

2.3. Check pressure on the pressure gauge, which should read approximately 3000 PSI.



2.4. Set the hydraulic pressure gauge selector switch to NORMAL.



3. Power system check

Set the engine speed to 45% rpm and check the voltmeter readings which should show approximately 28.5 V (at a lower rpm, the generator voltage may be a little less than the operating voltage).

8.3. Taxiing

1. Before taxiing, extend the flaps **[LShift + F]**.
2. Increase the engine speed to approximately 60% rpm to start moving. Then return the throttle to the IDLE position to allow the aircraft to move under its own momentum.
3. To turn the aircraft, use the rudder pedals (**[Z]** and **[X]** on the keyboard or the **[RZ]** axis of the joystick) and the nose wheel steering button **[S]** (press and hold until the turn is completed). When the nose wheel steering button is pressed, the utility pressure is applied to the turning mechanism installed in the nose leg and the wheel turns proportionally to the deflection of the rudder pedal. When the button is released, the wheel self-oriens and no longer depends on the position of the pedal.
4. When turning, check the operation of the TURN-AND-SLIP INDICATOR on the instrument panel, making sure the needle deflects.
5. During taxiing, verify that the pointer of the radio compass points towards the selected radio station.

Note. During taxiing, with the engine running at 35-45% rpm, the fuel consumption will be approximately 3 gallons (20 pounds) per minute.

8.4. Before Take-off

General Items Check

1. Check that the flaps are extended.
2. Check that the trim tabs are in the take-off position as follows:
 - 2.1. Center the control stick.

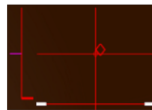

- 2.2. Activate the position indicator **[RCtrl + Enter]**.
- 2.3. Set the elevator trim tab to take-off position by pressing and holding **[RCtrl + ;]**. The control stick position indicator will start slowly moving downwards. Also, the take-off trim



position indicator light will glow briefly and then go out. When this occurs, the elevator trim tab take-off position is set.

2.4. Set the aileron trim tab to the take-off position by pressing and holding **[RCtrl + ,]** or **[RCtrl + /]**. The control stick position indicator will start slowly moving right or left respectively. When the trim tab is in the take-off position, the take-off trim position indicator light will glow briefly and then go out. If the aileron trim tab was in the neutral (take-off) position before-hand, the lamp will blink as soon as the keys are pressed.

2.5. Set the rudder trim tab to the take-off position by pressing and holding **[LCtrl + LAlt + A]** or **[LCtrl + LAlt + S]**. When the trim tab is in take-off position, the lamp will glow briefly and then go out. If the rudder trim tab was already in the neutral (take-off) position, the lamp will blink as soon as the keys are pressed.

3. Close the canopy using **[LCtrl + C]**, or by right clicking on the canopy switch.



4. Verify that the Gun Safety Switch is in the OFF position.



5. Verify the Oxygen Diluter Lever is set to NORMAL OXYGEN, **[LShift + D]**.



- If icing conditions are anticipated during take-off, position the engine anti ice and screen switch to ANTI-ICE, [**LAlt + LShift + S**], which retracts the intake screens if they are extended.



- Make sure that the nose wheel is pointing forward.
- Apply the brakes, [**W**], to check their operation and to check engine operation at high rpm before take-off.

Emergency Fuel System Check

- Set engine speed to 80% rpm.
- Set the EMERG FUEL switch to ON, [**LCtrl + V**].



- Slowly bring the throttle control fully forward while monitoring the rpm. Do not allow the rpm to go above 100% (overspeeding is indicative of a faulty fuel regulator).
- Set the EMERG FUEL switch to OFF.
- Set the EMERG FUEL switch back to ON.
- Check rpm recovery time when switching between main and emergency fuel systems and vice versa.
- Set the EMERG FUEL switch back to OFF in order to use the main fuel system for take-off.

Engine Check

1. Set maximum rpm with the throttle control.
2. Check the following:
 - the tachometer reads between 98 - 100%;
 - the turbine exhaust temperature gauge reads between 675 - 690°C;
 - the oil pressure gauge reads between 10 - 22 PSI.

8.5. Take-off

1. Set the throttle control to full OPEN.
2. Release the brakes.
3. Pay special attention to directional control during the take-off run. During the first part of the take-off run, maintain directional control by use of the nose wheel steering (by pressing the pedal keys, **[Z]** and **[X]**, in conjunction with the nose wheel steering button, **[S]**).

Rudder control becomes effective at approximately 50 knots IAS. At this speed, it is recommended that directional control is maintained without the use of the nose wheel steering (to prevent abrupt directional overshoots).

4. 20-30 knots prior to nose wheel lift-off speed (see [Table 8.1](#)), slowly pull the control stick by approximately 1/2 travel



Figure 8.1. Position of the flight stick, when the speed is 20-30 knots lower than what is required for the nose wheel to lift

so that the nose wheel lifts up at the preset speed which is dependant on the take-off weight.

Table 8.1

Take-off weight, lbs	Indicated speed of nose wheel lift-off, knots	Take-off indicated speed, knots
15,000	100	115
18,000	110	135
20,000	120	140

5. After the nose wheel lifts off, continue the run, maintaining nose pitch (by slowly pushing the stick forward) until the take-off speed is achieved and



Figure 8.2. Position of the flight stick and canopy before lift-off from the runway the aircraft slowly pulls off the runway.

6. When the aircraft takes off, retract the landing gear.
7. After reaching an altitude of 100-150 feet and a minimum speed of 140 knots, retract the flaps.

Warning.

1. Avoid abrupt and steep control stick movements during the ground run and take-off.
2. Do not retract the landing gear until the aircraft accelerates to a speed approximately 5 knots higher than the take-off speed for the given weight.

8.6. Climb

After take-off, maintain the preset climb angle using trim.

For optimal climb, i.e. a full power rate of climb with minimum IAS drop, accelerate to 455 knots IAS at sea level and start climbing at such a rate so that airspeed decreases by 50 knots for every 10,000 foot increase in altitude (see [Table 8.2](#)).

Table 8.2

ALTITUDE, thousands of ft	IAS, knots
SEA LEVEL	455
5	430
10	400
15	385
20	350
25	325
30	300
35	285
40	255
45	230
50	205
55	180

Altitude gain is defined by a number of inter-related tactical parameters: the time of climb, the distance covered by the plane while gaining altitude, and the fuel amount for reaching the defined altitude. [Figure 8.3](#) shows the relationship between the parameters and the method for calculating them.

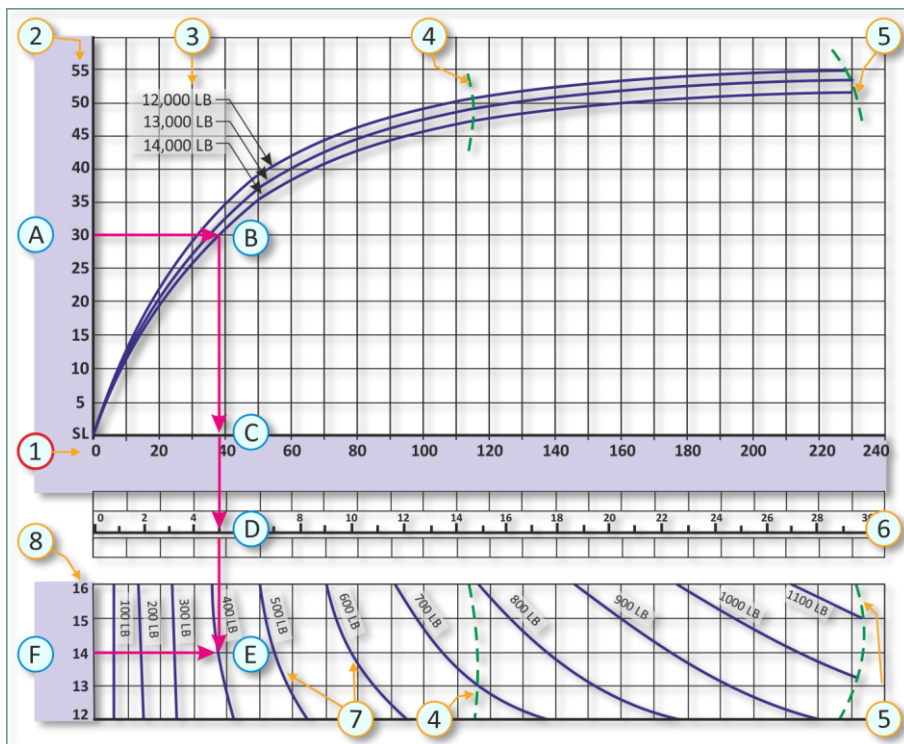

Figure 8.3. Graph for calculating climb parameters

- | | |
|---------------------------------|--|
| 1. Air distance, nautical miles | 5. Service ceiling |
| 2. Altitude, thousands of ft | 6. Time of climb, minutes |
| 3. Gross weight (sea level) | 7. Fuel used |
| 4. Optimum range altitude | 8. Gross weight, thousand of lbs (sea level) |

Procedure for determining climb parameters (example)

The airplane has a takeoff weight of 14,000 lbs. The required altitude is 30,000 ft. Calculate the climb parameters.

1. Find the required altitude on axis (2), point (A) and draw a horizontal line until it intersects the 14,000 lbs takeoff weight curve (3), point (B). Then draw a perpendicular line vertically down until it intersects with axis (1), point (C). This gives a calculated climb distance of 38 nm.

2. From point (C), continue drawing the vertical line until it intersects with the time scale (6), point (D). This gives a calculated climb time of 5 minutes.
3. From point (D), continue drawing the vertical line down until it intersects the fuel used curve (7), point (E). Then draw a horizontal line from the takeoff weight axis (8), point (F) to the fuel used curve (7), point (E). In this case, the fuel used during the climb is determined to be 400 lbs. If a point is between fuel used curves, determine an approximate amount of fuel used based on where the point (E) is located between the curves.

8.7. Approach and Landing

Note. It is recommended that, during approach, airspeed be decreased to gear and flaps-down speed (185 knots) through use of the air-brake (speed brakes).

Since the engine has poor acceleration characteristics between IDLE and 63% rpm, engine speed should not be decreased below 63% during approach in order to prevent stalling.

Effective braking is achieved by use of the speed brakes.

On approach, use power as required to maintain a rate of descent of less than 1,500 feet per minute.

Following these procedures will help you achieve the required speed, direction, and glideslope angle, facilitating the landing. A sample landing pattern is shown in [Figure 8.4](#) below.

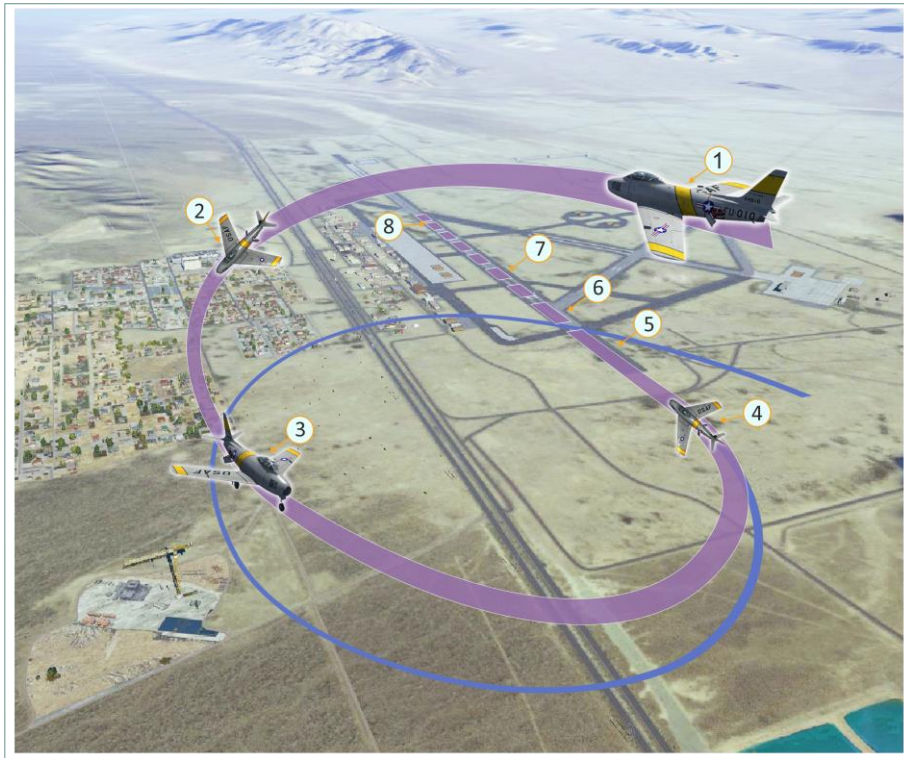

Figure 8.4. Approach and Landing

1. For effective deceleration, especially during descent, extend the speed brakes and decelerate to 185 knots IAS (gear and flaps-down limit speed).
2. At IAS below 185 knots, extend the landing gear and flaps. Check locking of landing gear by watching the position indicators.
3. Hold IAS at approximately 140 knots after gear and flaps are lowered.
4. Continuously monitor the glideslope angle (by verifying the touch-down point near the runway threshold) and approach direction.
5. When close to touch-down, gradually decrease the sink rate until the aircraft is flying level at approximately 3-5 feet above the runway and decelerating. Decrease rpm by setting the throttle to IDLE.
6. As the aircraft continues to descend, pull slowly back on the control stick to achieve a landing on the two main wheels at approximately 115 knots IAS.

7. During the first part of the landing roll, keep the nose wheel up for airbraking.
8. After the nose wheel touches down, start braking with the main wheels (amount of braking needed is dependant on the length of remaining runway).
9. After the aircraft has turned off the runway, retract flaps and speed brakes.

Warning.

Do not allow speed during approach or before touch-down to fall below stall speed (see [Figure 10.4](#)). Aircraft with landing gear and flaps down will stall abruptly with little stall warning buffet.

Note. Stall IAS during approach and landing will somewhat increase as the landing weight increases.

8.8. Taxiing in and Engine Shutdown

Engine shutdown procedure is as follows:

1. Set the throttle control to OFF, [\[End\]](#).
2. When rpm drops below 10%, set ENGINE MASTER SWITCH to OFF.

HOW TO USE CHART:

- 1 Select your indicated airspeed.
- 2 Trace vertically to your flight altitude.
- 3 Move horizontally to the left and find the maximum G you can pull at that airspeed and altitude before stalling.

OPERATING FLIGHT LIMITS

CLEAN AIRPLANE

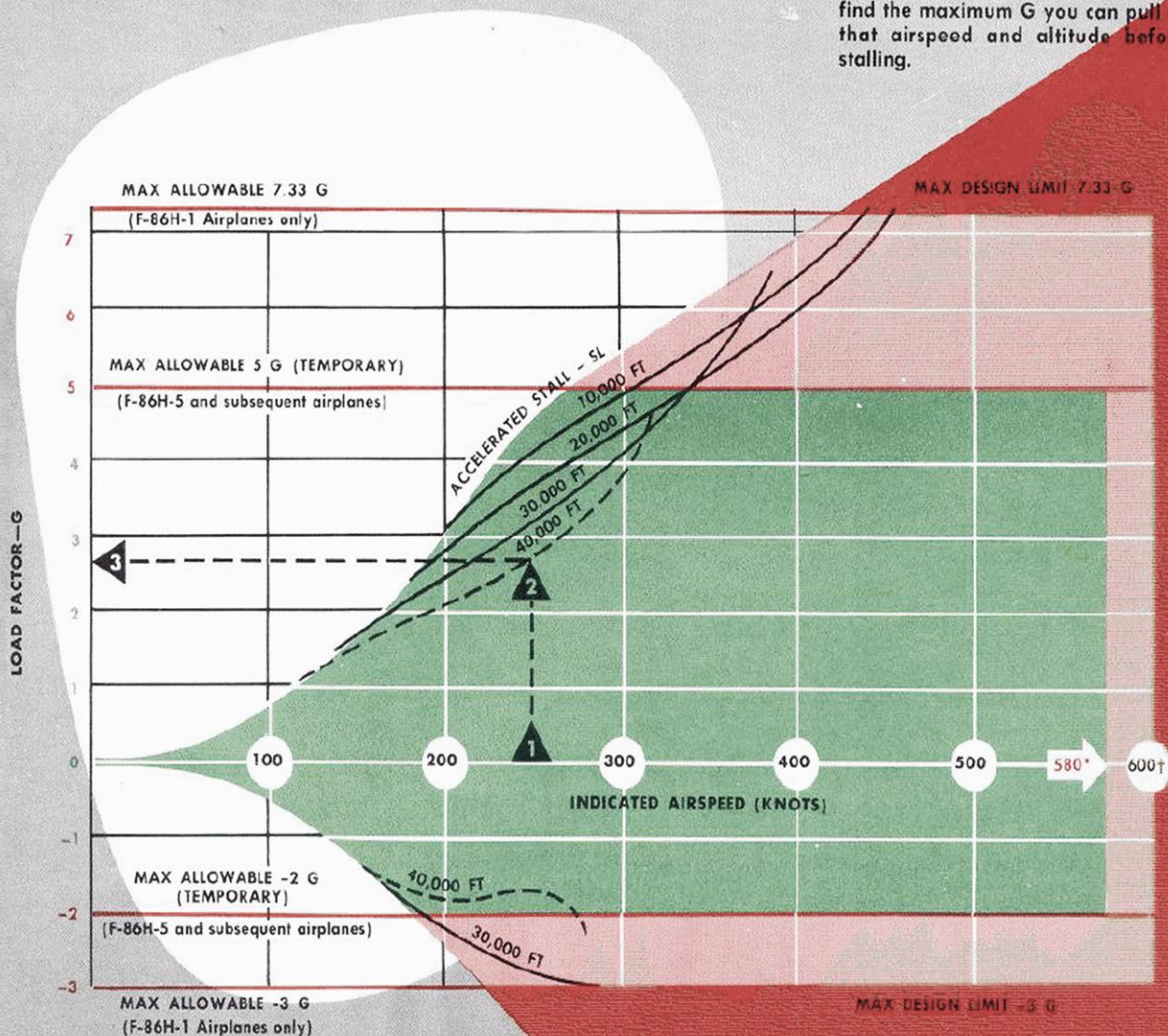

9. OPERATING LIMITATIONS

9.1. Engine limitations

9.1.1. Engine oil pressure limitations

Oil pressure limits for various engine rpm settings are given in Figure 9.1

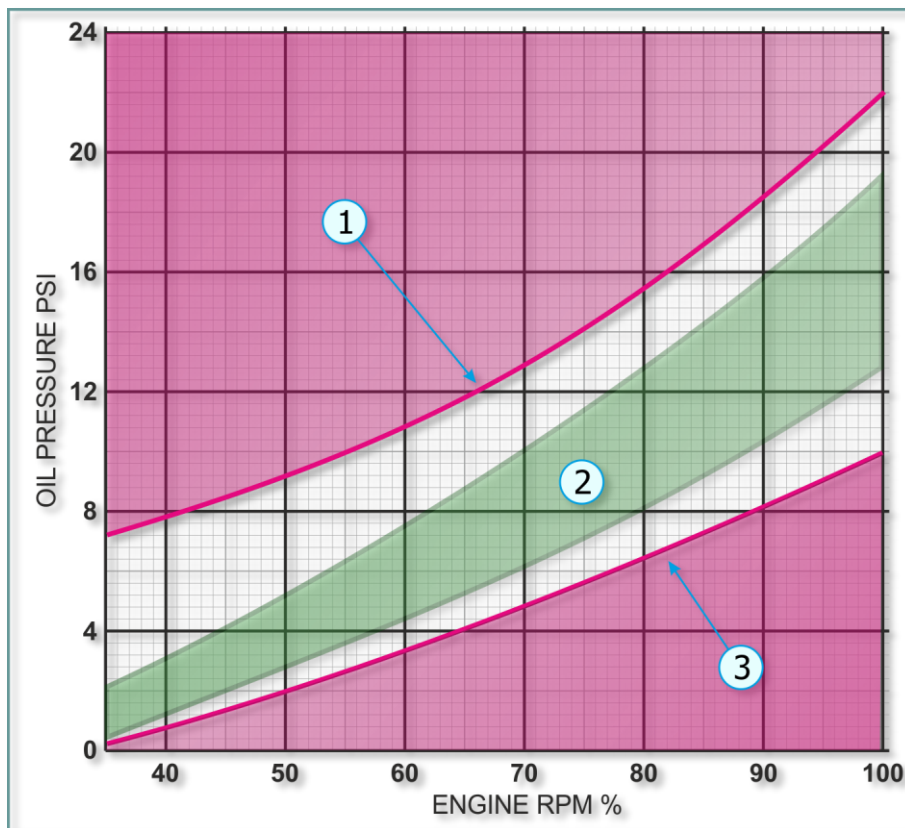

Figure 9.1. Engine oil pressure limitations

- 1. Upper limit of oil pressure values
- 2. Area of normal oil pressure values
- 3. Lower limit of oil pressure values

9.1.2. Engine overtemperature

See [here](#).

9.2. Airspeed and acceleration limitations

9.2.1. Missile safe-launch speed

The GAR-8 missile must be safe-launched within the limitations described in [Table 9.1](#).

9.2.2. Landing gear and wing flap lowering speeds

The maximum airspeed for lowering the gear and flaps is 185 knots IAS and is denoted by a yellow radial on the airspeed indicator. Gear or flap lowering at a speed in excess of this value may cause damage to fairings or the operating mechanism.

9.2.3. Landing light extension speed

The landing lights are designed for extension only on the final approach after landing gear and flaps have been lowered. Do not lower these lights at speeds above 185 knots IAS.

9.2.4. Canopy operating speed

The maximum airspeed for opening the canopy is 215 knots IAS. At speeds in excess of this value, opening the canopy may cause structural damage.

9.2.5. Airspeed and acceleration limitations depending on the configuration

Maximum allowable indicated airspeeds or Mach numbers are shown in [Table 9.1](#). High-speed flight, when external loads are carried, may be further restricted by general airplane buffet. This buffet may be experienced in the higher speed ranges and will, consequently, necessitate an airspeed limit. When no external loads are carried, high-speed flight in the transonic region may be limited by the airplane's rolling tendencies. Above 15,000 ft, wing roll will still be evident but may be checked more easily. At these higher altitudes, airspeed limitations of the airplane with no external load are determined only by how easily wing roll can be controlled as well as by general flight characteristics.

However, Mach limits for airplanes with certain external loads must still be observed.

Table 9.1

#					Airspeed limitations	G-Limits
	Outboard Station	Inboard Station	Inboard Station	Outboard Station		
1	clean	clean	clean	clean	600 knots IAS or airspeed where wing roll is excessive	+7 -3
2	-	120 gal drop tank	120 gal drop tank	-	Above 25,000 ft: Maximum attainable while avoiding buffet regions. Below 25,000 ft: 500 knots IAS or Mach .90, whichever is lower.	tanks WITH fuel +5.5* -2 tanks EMPTY +6* -2
3	200 gal drop tank	-	-	200 gal drop tank	600 knots IAS or airspeed where wing roll is excessive' Avoid buffet regions. No continuous rolls	tanks WITH fuel +5 -2 tanks EMPTY +5.5* -2
4	-	AN-M64 bomb	AN-M64 bomb	-	Above 15,000 ft: Mach .90. Below 15,000 ft: 500 knots IAS or Mach .90, whichever is lower. No continuous rolls.	+4 -2
5	4x 5" HVAR	4x 5" HVAR	4x 5" HVAR	4x 5" HVAR	Maximum attainable while avoiding buffet regions. No continuous rolls	+6 -2
6	200 gal drop tank	4x 5" HVAR	4x 5" HVAR	200 gal drop tank	Above 25,000 ft: Maximum attainable while avoiding buffet regions. Below 25,000 ft: 550 knots IAS or Mach .90, whichever is lower.	+5 -2
7	200 gal drop tank	AN-M64 bomb	AN-M64 bomb	200 gal drop tank	Above 25,000 ft: Maximum attainable while avoiding buffet regions.	+4 -2

					Below 25,000 ft: 550 knots IAS or Mach .90, whichever is lower.	
8	120 gal drop tank	AN-M64 bomb	AN-M64 bomb	120 gal drop tank	Above 25,000 ft: Maximum attainable while avoiding buffet regions. Below 25,000 ft: 500 knots IAS or Mach .90, whichever is lower. No continuous rolls.	+4 -2
9	200 gal drop tank	120 gal drop tank	120 gal drop tank	200 gal drop tank	Above 25,000 ft: Maximum attainable while avoiding buffet regions. Below 25,000 ft: 500 knots IAS or Mach .90, whichever is lower. No continuous rolls.	+5 -2
10	–	GAR-8 Missile (on missile station)	GAR-8 Missile (on missile station)	–	600 knots IAS or airspeed where wing roll is excessive	+6 -3
11	GAR-8 Missile (on missile station) and any drop tanks (120 or 200gal)				Limitations are the same as for respective 'drop tanks only' configuration	

9.2.6. Prohibited maneuvers

The airplane is restricted from performing the following maneuvers:

1. Snap rolls or any snap maneuvers.
2. Intentional spins with bombs, rockets, or 200-gallon drop tanks installed.

NOTE. Inverted flight, or any maneuver resulting in negative acceleration, must be limited to 10 seconds duration, as there is no means of ensuring a continuous flow of fuel while in this attitude.

3. Continuous rolls when certain external loads are installed (see [Table 9.1](#)).

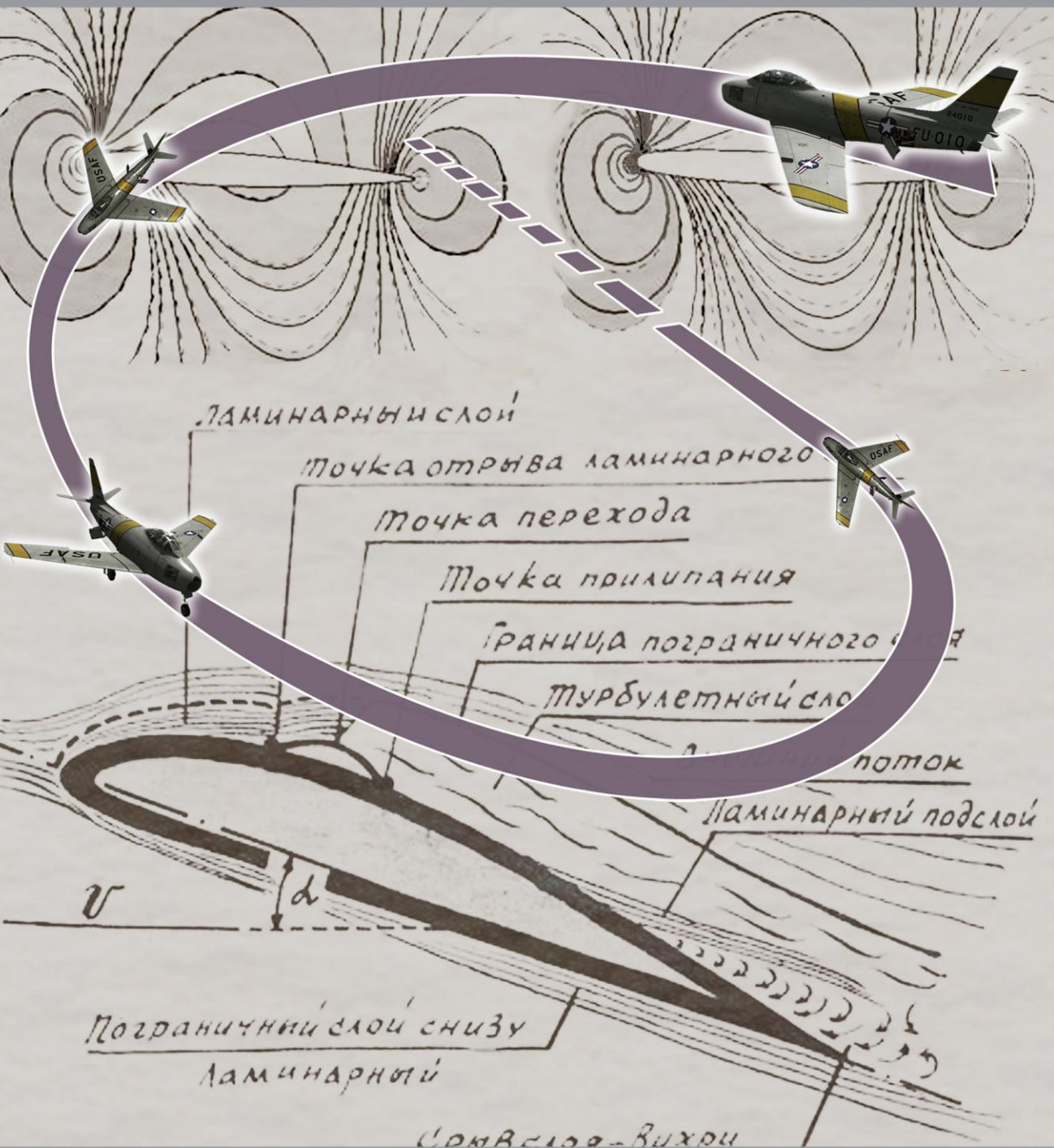

10

AIRCRAFT AERODYNAMIC
PARTICULARS

10. AIRCRAFT AERODYNAMIC PARTICULARS

10.1.1. High speed

There are several specific phenomena which appear when the airplane approaches a higher IAS and Mach number (within allowed limits).

Starting at Mach 0.9, an unintentional roll to the left or right appears, known as wing heaviness or wing roll, which increases as Mach number increases up to the limits of the aircraft. The emergence of the wing heaviness is connected to asymmetry between wing consoles and an unequal stiffness against bending and twisting. The wing heaviness is accompanied by a substantial reduction in the ailerons' efficiency which is due to wave effects and wing deformation when the ailerons are deflected.

At high speeds, the influence of air flow compression on the aircraft's longitudinal stability and controllability remains low up to Mach 0.95. As the Mach number increases, however, the airplane shows an increased tendency to pitch up, which the pilot must compensate for by adding an additional forward force to the control stick.

Due to the aforementioned behavior, indicated air speed (IAS) at lower altitudes is limited to 600 knots.

Speeds higher than Mach 0.93 are only possible in a dive.

10.1.2. Maneuverability

At all speeds, the airplane is sensitive to pitch inputs. This is especially noticeable at a Mach number of 0.8-0.9 and an IAS higher than 500 knots. The aircraft is also very maneuverable at all speeds and Mach numbers. The pilot, therefore, must take this into account and apply subtle deflections to the controls (especially in the roll channel).

However, at medium and low altitudes and an IAS higher than 550 knots, roll control becomes sluggish making performing maneuvers difficult. This is due to wing twisting and bending which reduces the efficiency of the ailerons.

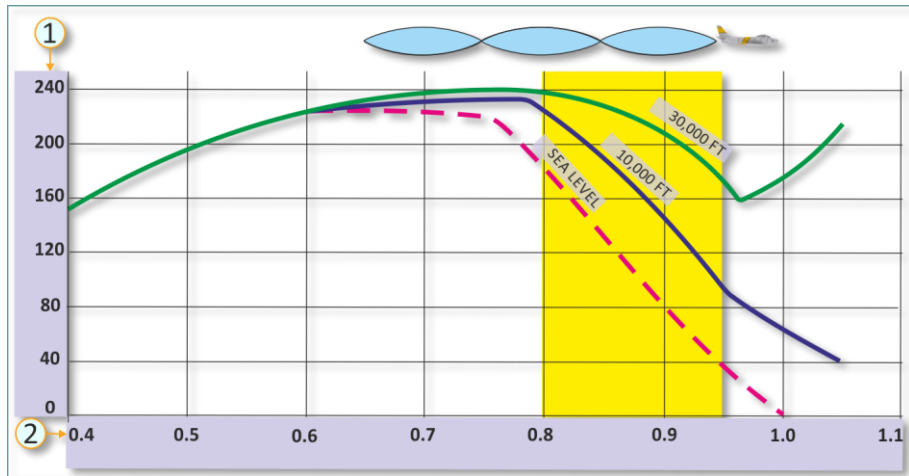

Figure 10.1. Available roll rate

1. Angular roll rate, degrees/s

2. Speed of the airplane, Mach

10.1.3. Glide ratio

Glide ratio of the airplane is the lift to drag ratio for a given angle of attack.

Maximum glide ratio corresponds to the optimal angle of attack which gives maximum gliding distance.

Simply put, glide ratio can be considered the distance the airplane can fly from some altitude in calm weather conditions with the engine off.

The F-86F Sabre has a good glide ratio ("flyability") as demonstrated by the graph below which clearly shows the fighter's ability to glide from various altitudes in the event of an engine stop. With the engine operating at "Idle", gliding distance is even longer because drag is reduced.

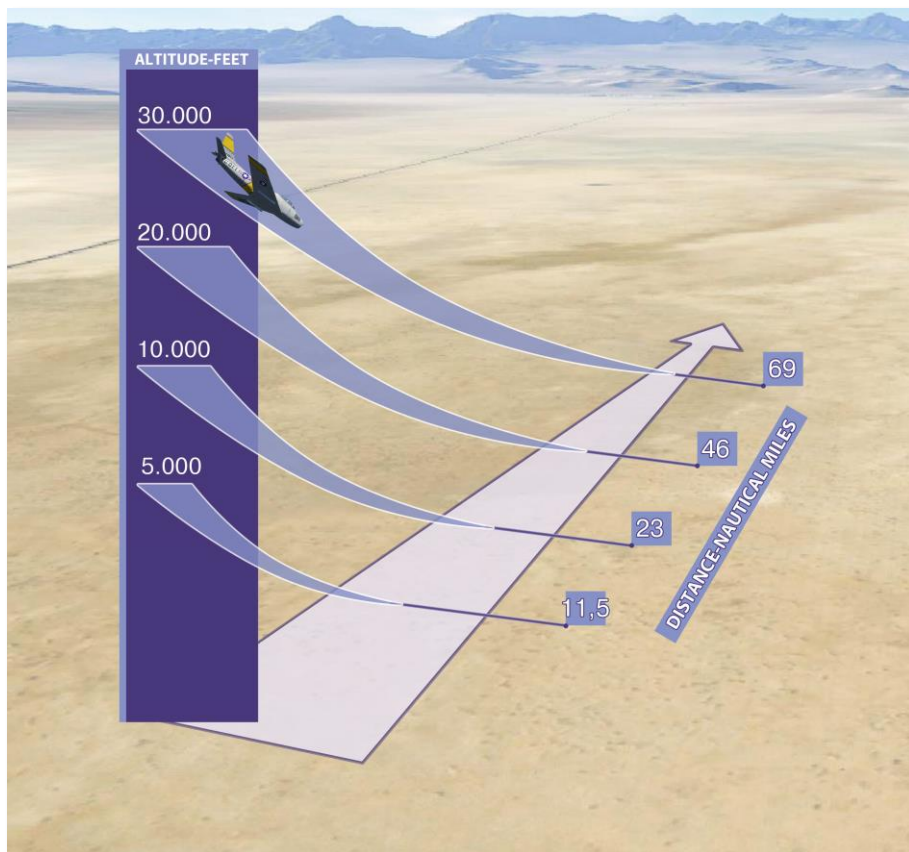

Figure 10.2. Gliding distances (nm) from different altitudes (ft) with the engine off

10.1.4. Exceeding allowed G-factor

An interesting feature of the F-86F is the increased response to control stick movements in the longitudinal channel. This responsiveness can lead to the airplane stalling or exceeding its maximum allowed G-factor.

Speeds and altitudes with typical G-limitations are depicted in [Figure 10.3](#).

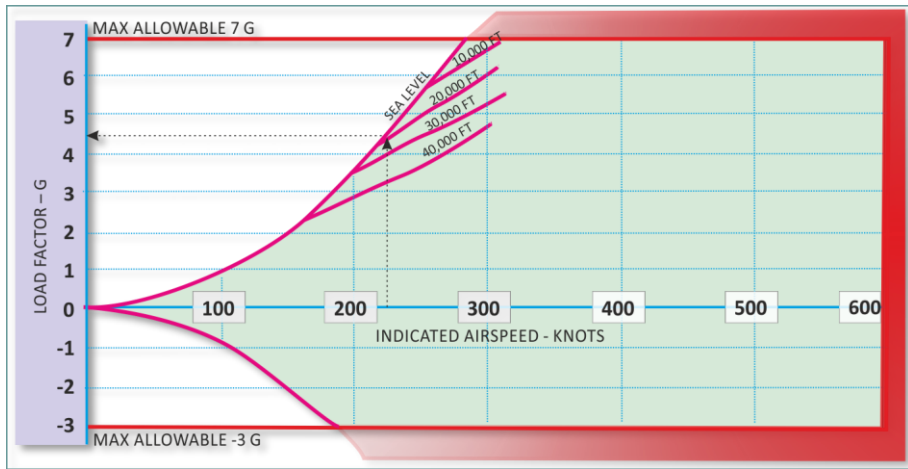

Figure 10.3. Allowed G-factors

The aircraft's tendency to stall, accompanied by buffet, is a warning that the allowed G was exceeded. Piloting with buffet is possible but requires additional attention to the aircraft's behavior as well as the G-factor which must be reduced in good time as IAS decreases.

10.1.5. Stall

Stall occurs very sharply to any side, simultaneously with yaw oscillations and a lowering nose. In addition, a reverse reaction to stick movement in the longitudinal channel (roll) occurs.

During landing, the pilot must strictly maintain the recommended speed, not allowing it to drop to stall speed in various configurations (see [Figure 10.4](#)).

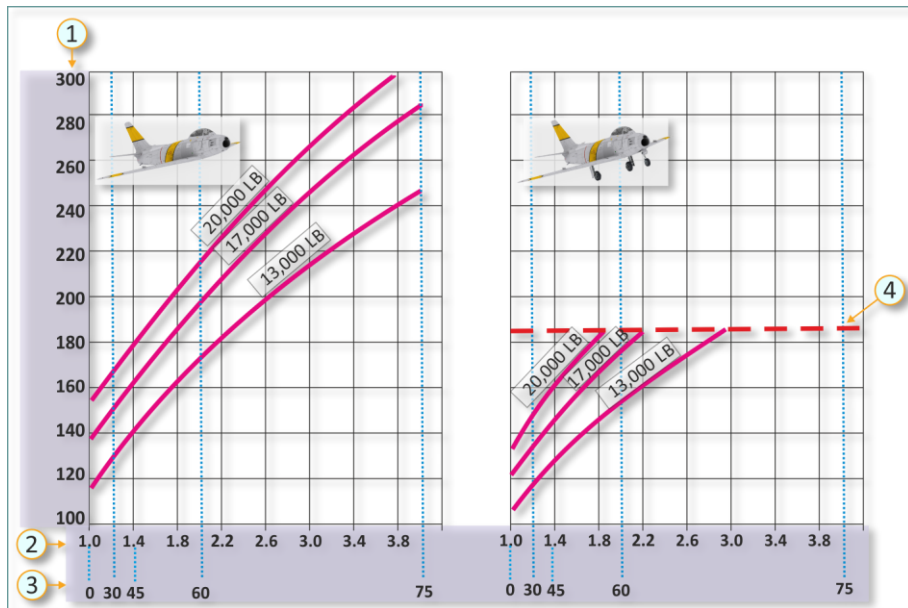

Figure 10.4. Stall Speeds (Left – Gear and Flaps Up, Right– Gear and Flaps Down)

1. Indicated air speed (IAS), knots
2. G-factor, units
3. Roll angle, degrees
4. Maximum allowed speed with extended gear and flaps (185 knots)

Stall in level flight, with the engine operating at maximum, occurs at lower speeds in any configuration. This is because, at positive angles of attack, the engine is creating a vertical component of thrust which is reducing the required lift and, consequently, the required angle of attack.

Absence of external stores reduces stall speed by approximately 10 knots.

If the control stick is pulled too aggressively, rapid stall can occur without buffet (due to high pitch response).

10.1.6. Stall recovery

Recovery from a stall is done by the pilot pushing the flight control stick slightly forward and increasing engine RPM.

10.1.7. Spin

The airplane can enter a spin in any configuration and at any speed up to 0.9 Mach. A spin is always caused when, during maneuvering, the aircraft is stalled while exceeding the allowed G-factor or when speed falls below the allowed speed for current weight and flight configuration.

When the pilot follows the spin recovery procedure, taking into account available altitude, the airplane can recover to normal flight from any type of spin.

When the airplane enters a spin, the nose of the airplane descends below the horizon at an angle of 50-75° with slow rotation. Eventually, spin rate increases and the nose of the airplane lifts almost to the horizon. The first spin revolution takes around 5-8 seconds, with an altitude loss of 500-600 ft. Further spin revolutions are characterized by higher rotational speeds, the nose not lifting as much towards the horizon, and an increasingly vertical trajectory angle. Therefore, each subsequent revolution can result in an altitude loss of up to 2000 ft.

Spin with increased engine power is characterized by smaller trajectory angles and faster spin revolutions. Conversely, spin with minimum thrust or with a stopped engine is characterized by a steeper trajectory (up to 90° during spin development).

In landing configuration, the spin is characterized by smaller altitude loss during the first revolutions. Also, if the airplane has drop tanks, the spin can reverse from its initial direction after several revolutions.

It should be noted that the airplane is more likely to enter a spin to the right and that extended airbrakes do not change spin behavior.

10.1.8. Recovery from the spin

The airplane will eventually exit from the spin if the control stick and pedals are returned to their neutral positions. However, to quicken recovery, the pilot can apply the steps listed below.

Spin recovery procedure:

- return the flight stick to the neutral position;
- set the thrust handle to the "IDLE" position to reduce altitude loss;
- apply rudder opposite to the direction of the spin.

If the airplane enters a spin with non-empty pylons and does not recover within one to one and a half spins, it is recommended to jettison stores and follow the spin recovery procedure.



11

COMBAT EMPLOYMENT

11. COMBAT EMPLOYMENT

11.1. Gunnery employment

11.1.1. Firing Guns Using Radar

When firing at stationary ground targets or in the case of sight resolver failure, the mechanically caged 100-mil fixed reticle is used (mechanical caging lever is at CAGE).

Note. To assist in setting up the controls for the gun and A-4 sight, the kneeboard is available ([Figure 13.2](#)).

Procedure for firing the guns using radar:

1. Check that the RADAR INV OFF light on the instrument panel is out.

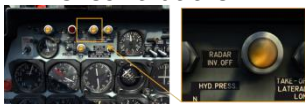

2. Before using the sight:

- place the gun-missile selector switch on the center pedestal to SIGHT



CAMERA&RADAR (to cause the gyro to start spinning and the equipment to be set up). Before turning the gyro on, it should be caged mechanically to the sight (i.e. the sight mechanical caging lever should be set to CAGE).



- turn the twist-grip counter-clockwise [;] until it stops for maximum range.



3. Move the sight mechanical caging lever to UNCAGE
4. Adjust the Sight Reticle Dimmer Control Knob (rotate clockwise to



increase image brilliance)

5. On the Sight Selector Unit:



- set the Sight Function Selector Lever to GUN ([L]Ctrl + [D] rotates the lever clockwise, [L]Alt + [D] rotates the lever counter-clockwise).



- set the Target Speed Switch to LO or HI



6. Set the Gun-Missile Selector Switch to GUNS
7. Adjust the target wing span using the wing span adjustment knob



[/] [.]

- Depress and hold the sight electrical caging button to stabilize the reticle



image [\[Tab\]](#) (if not already stabilized).

- After the radar target indicator light comes on (at a target range of approximately 4,800 feet / 1,460 m), release the electrical caging button to enable target tracking. As the caging button is released, the reticle will drift down and then move back to the proper lead angle.
- When you can track the target smoothly for approximately one second



without slipping or skidding, fire [\[Space\]](#).

11.1.2. Firing Guns Without Radar

- Adjust the target wing span by rotating the wing span adjustment knob

on the sight to the appropriate value :

- wing span decrease – [\[7\]](#)
- wing span increase – [\[8\]](#).



- Depress and hold the sight electrical caging button [\[Tab\]](#) to stabilize the reticle image [\[Tab\]](#) (if not already stabilized).



3. Rotate the throttle grip (manual ranging control) so that the reticle circle continuously frames the target and continue tracking until you approach the proper firing range:
 - manual range decrease - [.]
 - manual range increase - [;].
4. Release the sight electrical caging button [Tab] and maneuver to keep the target within the reticle.
5. When you can track the target smoothly for approximately one second



without slipping or skidding, fire [Space].

11.2. Bomb employment

This section covers the procedures for the three different bombing methods; namely, using the sight without manual PIP control (MPC), using the Low-Altitude Bombing System (LABS), and using the sight with manual PIP control. Emergency release is also covered in this section.

11.2.1. Bomb employment using sight without MPC

Bombing preparation and execution can be done by using the controls on the



Center

Pedestal



and the A-4 sight

Procedure

1. Check that the RADAR INV OFF light on the instrument panel is out.



2. Before using the sight, place the gun-missile selector switch on the



center pedestal to SIGHT CAMERA&RADAR (to cause the gyro to start spinning and the equipment to be set up). Before turning the gyro on, it should be caged mechanically to the sight (i.e. the sight mechanical caging lever should be set to CAGE).



3. Move the sight mechanical caging lever to UNCAGE

- Adjust the sight reticle dimmer control knob (rotate clockwise to increase



image brilliance)

- Set the camera lens switch as desired.
- Set the demolition bomb release selector switch (AUTO – MANUAL)



depending on the selected mode of release

- Select the release sequence using the demolition bomb sequence



selector switch (ALL – LEFT – RIGHT)

Make sure the



fragmentation bomb selector switch implemented in the simulator).

is placed at OFF (if

- On the Sight Selector Unit, set the Sight Function Selector Lever to



BOMB

[LCtrl + D] or [LAlt + D].



9. Before commencing the dive, set the bomb-arming switch to the desired position (do not leave in the neutral position, otherwise, the bombs will not explode). Then depress **and hold** the sight electrical caging button in the throttle to stabilize the reticle image [Tab] (if not already stabilized).
10. Push over into a steep enough dive to get a good visual on the target.
11. While maintaining the attack approach, keep the reticle center dot on target and then **release** the electrical caging button [Tab] to uncage the sight (initiates computer operation).
12. If automatic release has been selected, depress the bomb-rocket release button and keep it depressed [RAIt + Space] while keeping the reticle center dot on the target.

KEEPING THE RETICLE CENTER DOT ON TARGET DURING A DIVE REQUIRES A CERTAIN PROCEDURE.

When the sight function selector lever of the sight selector unit is placed at BOMB and the sight is uncaged, the dot will automatically depress to 10° below the fuselage reference line. Therefore, if aircraft pitch is kept constant, the dot will always be placed ahead the target. Adjust the aircraft pitch to put the dot on the target. Then, to keep it on the target, place the aircraft into a curved flight path with an ever increasing pitch angle (by pushing the control stick forward). As soon as the G-load falls below 1.0, the bomb will be tripped automatically.

Automatic release is indicated by the disappearance of the reticle image.

13. If manual release is selected, the center dot should be kept on the target (similarly to the automatic release method described above) until the dot disappears at the calculated release point. At this moment, depress the bomb-rocket release button [RAIt + Space].
14. Break away.

Note. To change the sight over to guns, press [LCtrl + D] or place the Sight Function Selector Lever to GUN.

11.2.2. Bomb employment using LABS

Bombing preparation and execution can be done by using the controls on the



Procedure

1. Fly nap-of-the-earth at 400 knots until you reach the outer edge of the short-range air defense systems protecting the target (can be 10-12 km).

Enable LABS by putting the two right-most switches in the up position but leaving the gyro caging switch in CAGE.

2. Place the demolition bomb sequence selector switch on the central

weapons control pedestal  to any position other than OFF.

3. While maintaining 400 knots and keeping the wings as level as possible,

uncage the LABS gyro by placing the switch to UNCAGE .

4. Steer towards the target while maintaining 400 knots.
5. While flying over the target center, depress and hold the rocket-bomb



release button on the control stick, increase thrust to maximum, and immediately pitch the nose up to reach 4 G in 2 seconds.

6. While pitching-up, monitor the G meter to ensure you are maintaining 4 G. Also, watch the LABS dive-and-roll indicator to ensure roll remains at 0°.
7. The bomb will be released at an altitude of approximately 4,600 ft with a pitch angle of 110°. The bomb will have an initial speed of 260 knots at release and will fall onto the target following the parabolic path shown in [Figure 11.1](#).

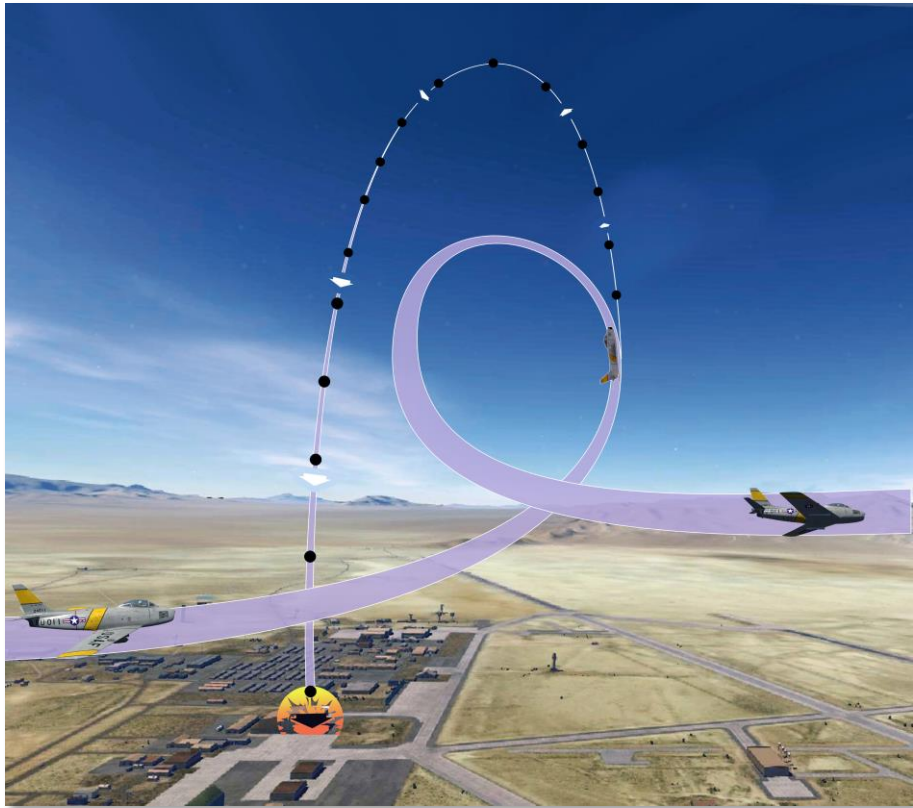

Figure 11.1. General Principles of LABS Employment

8. After the bomb is released, wing over and break off. After proper training and practice, the bomb impact error should not exceed 60 to 70 meters (in the simulation).

During the LABS bombing maneuver, the roll indication on the dive-and-roll indicator (refer to [Figure 11.2](#)) should be kept as closely as possible to zero through precise deflections of the control stick. Similarly, attention should constantly be paid to the G load to ensure 4 G is maintained.



Figure 11.2. LABS Roll Indicator Reads 35° LH Roll

11.2.3. Bomb employment using sight and MPC

Bombing preparation and execution can be done by using the controls on the

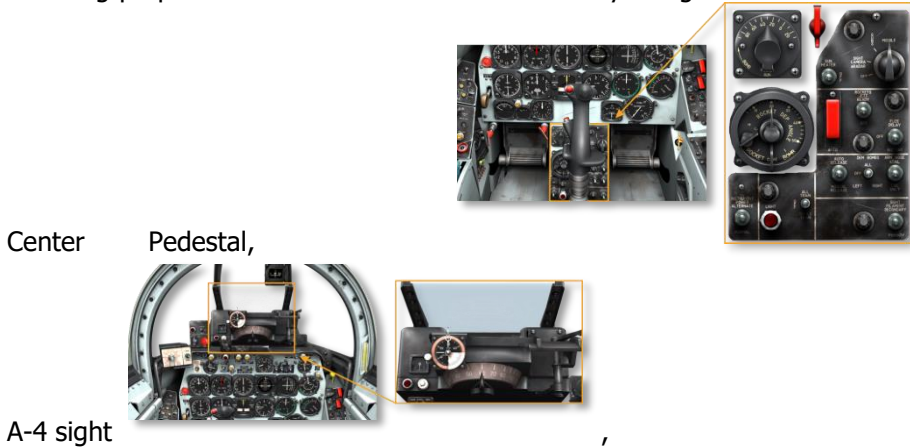

Center

Pedestal,

A-4 sight



and MPC panel

The procedure described below is based on the following scenario: the target is 1,400 ft above sea level and the aircraft will begin dive-bombing the target at a 60° angle and an initial altitude of 15,000 ft above the target.

Procedure

1. Turn the gun-missile selector switch to the SIGHT CAMERA RADAR



position to allow the sight to warm up



Adjust the sight reticle dimmer control for brightness

2. Set the sight mechanical caging lever to UNCAGED (to the right)



3. Set the sight selector unit to GUN

4. Set the demolition bomb release selector switch to MANUAL RELEASE



5. Set the bomb detonation delay as NOSE & TAIL or TAIL ONLY



6. On the MPC unit, set the switch to BOMB



7. On the MPC panel, select the required calibrated dial depending on the



conditions of the attack (15,000 ft above target in this example).

8. On the MPC panel, determine the index altitude (in hundreds of feet) by first identifying the estimated dive angle on the inner scale (60° in this example) and then choosing the corresponding value on the outer scale



(5,000 ft in this instance).

9. Set the obtained index altitude value on the bombing altimeter (attention: the bombing altimeter scale is calibrated in thousands of feet)



by turning the arm with the ring

To make the arm turn faster with the mouse wheel, the LShift combination can be used.

10. Set the target altitude above sea level (indicated by the red pointer)



using the rotary knob on the left side (in this example, target altitude is 1,400 ft above sea level).

11. Set the aircraft's speed according to the selected calibrated scale (288

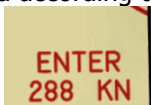

knots in this example) , open the speed brakes, and roll into desired dive angle towards the target with the throttle at idle.

Enter the dive through a half-roll: make a split (rolling left or right) to put the aircraft inverted, pull the control stick to put the aircraft's nose on target, and roll the aircraft back to an upright position. This is required to avoid the adverse effect of negative G-loads.

12. Once the desired dive angle has been achieved (can be verified by the attitude indicator), place the reticle pip on to the target.

The dive angle can also be monitored through the angle lines on the canopy.



In this example, the '60' line should be parallel to the horizon. For easy reference, the *quick-look feature* should be used.

As the air speed increases, the dive angle may decrease. Therefore it is necessary to closely monitor the dive angle and make timely corrections. For each 10° increase in the dive angle relative to the calibrated value, the release altitude should be increased by 500 ft. Conversely, for each 10° decrease in the dive angle, the release altitude should be decreased by 500 ft.

13. Prior to bomb release, keep the pip on the target for at least 2 seconds to ensure accuracy. When the bombing altimeter instrument pointer coincides with the white pointer on the index altitude arm,



depress the bomb-rocket release button and start the pull-out .



11.2.4. Bomb employment with mixed rocket and bomb load-out

When the aircraft has a mixed load-out of rockets and bombs and *BOMBS MUST BE RELEASED BEFORE ROCKETS ARE LAUNCHED*, proceed as follows:

- place the demolition bomb sequence selector switch



to

- place the rocket release selector switch



to **OFF**.

11.2.5. Bomb Emergency Release

Bombs can be jettisoned in an unarmed state through the stores jettison button (used for bombs, rockets, and fuel tanks and located on the left console

outboard of the throttle)



or with the jettison handle

(to the left, below the instrument panel)



Demolition bombs can be also released unarmed from the main release system if the BOMB-ARMING switch is in OFF.

Fragmentation bombs can not be released unarmed from the button on the control stick. However, if the complete fragmentation bomb rack is released with bombs installed, the bombs will not detonate: when released through the bomb-rocket-tank jettison button; when released through the emergency jettison handle; when FRAGMENTATION BOMB SELECTOR is placed at OFF and the DEMOLITION BOMB SEQUENCE SELECTOR (single-all selector) is placed at ALL.

11.3. Rocket employment

11.3.1. Rocket employment using sight

For rocket employment, the sight and controls should be set as follows:

1. Check that the RADAR INV OFF light on the instrument panel is out



2. Before using the sight, place the gun-missile selector switch on the



center pedestal to SIGHT CAMERA&RADAR (to cause the gyro to start spinning and the equipment to be set up). Before turning the gyro on, it should be caged mechanically to the sight (i.e. the sight mechanical caging lever should be set to CAGE).



3. Move the Sight Mechanical Caging Lever to UNCAGE
4. Adjust the Sight Reticle Dimmer Control Knob (rotate clockwise to



increase image brilliance)

5. Set the Rocket Intervalometer (on the left side) to '1' (or '9' if aircraft



carries drop tanks)

6. On the sight selector unit, place the Sight Function Selector Lever to



ROCKET [LCtrl + D].

7. On the sight selector unit, set the rocket drop correction using the rocket



setting lever:

- for a firing range between 5,000 to 6,000 ft and a dive angle up to 20°, set 35–40mil;
 - for a dive angle of 30 to 40°, set 25–35 mil.
8. Set the rocket release selector switch to AUTO (forced to this position



when the switch guard is down) or SINGLE



9. Place the rocket jettison switch to OFF

10. Set the rocket fuze delay setting to INSTANT or DELAY

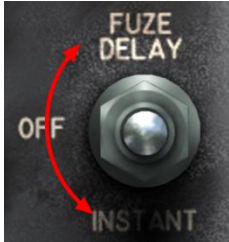

11. Determine the best approach to the target in order to achieve the optimal attack dive angle while keeping visual on the target.
12. Before dive entry, depress and hold the sight electrical caging button



to stabilize the reticle image **[Tab]** (if not already stabilized).

13. While maintaining the attack approach, keep the sight reticle center dot on the target and release the sight electrical caging button **[Tab]** to initiate resolver operation (uncage the sight gyro).
14. Continue to track the target smoothly for approximately 3 seconds



without slipping or skidding, then fire **[RAlt + Space]**.

Note. To change the sight over for bombing, press **[LAlt + D]** (to rotate the Sight Function Selector Lever counter-clockwise) or place the Sight Function Selector Lever to BOMBS.

To change over the sight to guns, press **[LAlt + D]** or place the Sight Function Selector Lever to GUN.

11.3.2. Rocket employment with mixed rocket and bomb load-out

When the aircraft has a mixed load-out of rockets and bombs, check the following if rockets are to be fired prior to bombs release:

- the demolition bomb sequence selector switch is placed at **OFF**;



- the rocket release selector switch is placed at any position **other than OFF**;



- the rocket intervalometer is set to '9'

11.4. Missile employment

11.4.1. GAR-8 Air-to-Air missiles employment

Fire the missiles as follows:

1. Turn the gun-missile selector switch to MISSILE



2. Move the sight mechanical caging lever to CAGE



3. When approaching the target area, move the missile safe switch to ARM and the missile control switch to LH & RH or RH



- Turn the volume control knob so that background signal is at a low audio



level

- Use the A-4 sight to track the target.
- Listen for the missile "ready" tone in the headset (signal indicates that the missile has detected an infrared target). Care must be taken to ensure the missile has locked on to the intended target and not a background heat signal. Readjust the "ready" signal as desired.

NOTE: There are situations where the missile can distinguish the target from background infrared sources but the lock may not be detectable to the pilot through the "ready" tone. When the pilot fires under these conditions, they must make sure the target is within the missile's firing envelope.

- The missile can detect targets that may be outside of its effective range.
 - If the target is within range but no "ready" tone is heard and there is concern about missile malfunction, move the missile control switch to RH if LH & RH was previously selected.
- Press the trigger to the second detent and hold until the missile is seen



leaving its pylon

8. When the engagement is over, return the gun-missile selector and missile control switches to their OFF positions.

11.5. Tactics of the first jet fighters

Extensive post-war re-equipment of air forces with jet aircraft did not, oddly enough, entail any significant changes to combat aviation tactics at first. Despite the new fighters being much more advanced than their war-time piston-engine counterparts in terms of their performance, basic principles of air-to-air operations remained the same.

This was due to the fact that the main armament of jet aircraft still comprised of machine guns and cannons. It was therefore inferred that aerial combat would remain at close-range. In such combat scenarios, pilots would attempt to enter their enemy's rear hemisphere at low aspect angles and close in until the enemy was within the effective range of the weapons.

The squadron remained the basic tactical unit in fighter aviation. To complete a mission, three tactical groups would be formed within a squadron:

- an attack group;
- a combat air patrol;
- a contingency group.

11.5.1. Fighter Formation

With consideration now having to be given to increased aircraft speeds and the necessity for sufficient maneuvering room, fighter command orders of battle had become more dispersed. Fighter cells intended for air combat were divided into pairs that had to maintain fire coordination at all times. The trail pair was considered the screening one. Therefore, it virtually never changed its position in the combat order during different stages of the flight. This pair would also be positioned higher than the leading pair when scanning the air space.

Once the enemy was found and approached, the cell formation would deploy in depth in order to ensure better protection of the leading pair against enemy fighters and to concentrate fire during the course of the attack.

11.5.2. Changes in the function of ground-based command posts

Due to the significant increase in combat ranges, control of the dispersed battle order of fighters in the air became more challenging. High air speeds combined with vigorous maneuvering prevented group leaders from continuously

supervising their wingmen. Therefore, theorists and practitioners in the field of aviation soon realized that ground-based command posts, with their radar aids, were becoming more and more essential to aerial combat.

11.5.3. Main tasks of ground-based command posts included the following:

- maintaining continuous communication with pilots;
- directing friendly aircraft to enemy aircraft;
- directing friendly aircraft to more tactically advantageous positions for successful enemy engagement;
- alerting pilots regarding all consequent actions of the enemy.

Radars, far from perfect at the time, could not provide pilots with the means to independently search for air targets and track their activity. Therefore, the ground combat control officer had become an essential part of the air battle (on par with the pilots) and often played a critical role in the battle's outcome.



12

EMERGENCY PROCEDURES

12. EMERGENCY PROCEDURES

12.1. Engine failure

12.1.1. Engine failure during flight at low altitude

If an engine failure occurs during flight at low altitude and with sufficient airspeed available, the airplane should be pulled up (known as a zoom-up) to exchange airspeed for an increase in altitude (see [Table 12.1](#)). This will allow more time for accomplishing subsequent emergency procedures (performing an air start, establishing a forced-landing pattern, ejecting, etc).

NOTE. The point at which the climb should be terminated will depend on whether the pilot intends to eject or whether he intends to continue attempting air starts, establishing forced-landing patterns, etc. In any event, it is recommended that an air start be attempted immediately upon detection of an engine flame-out and repeated as many times as possible during the zoom-up. If the decision is to eject, the airplane should be allowed to climb as far as possible. In this situation, the optimum zoom-up technique is to pull the airplane up with wings level until light buffet is encountered. Then, hold this light buffet until the speed drops to 120 knots IAS or the rate of climb approaches zero before ejecting. If the decision is to continue attempting air starts, the climb should be terminated before the aircraft drops below best glide speed in order to obtain the maximum glide distance and to maintain adequate engine windmilling rpm for an air start.

Maximum altitude can be achieved by jettisoning external stores before zoom-up. The longer external stores are kept during the climb before being jettisoned, the less the additional altitude that will be gained. However, before external stores are jettisoned, consideration must be given to such factors as the terrain the stores will fall on to (populated areas, friendly or enemy territory, etc), the type of stores to be jettisoned (full or empty drop tanks, etc), and controllability of the airplane if one or more stores fail to release resulting in a dangerous asymmetrical condition at low altitude. In addition, there are flight limits that should be observed when jettisoning stores to prevent damage to the airplane. It is impossible to predict the extent of damage that may occur if external stores are released outside the established limits because of the number of factors involved. However, depending on the emergency, it may be advisable to jettison the external stores outside the release limits and risk some

damage to the airplane in order to improve the chances of successfully accomplishing subsequent emergency procedures. In any event, the decision to jettison or retain external stores must be made based on an evaluation of the existing factors at the time of the emergency.

12.1.2. Engine failure after take-off

If the engine fails on take-off after the airplane becomes airborne, proceed as follows:

1. Set the EMERGENCY FUEL SWITCH to ON.

Warning. If engine rpm has fallen below 80% rpm, you will not have time to retard the throttle to IDLE. Therefore, set the emergency fuel switch to ON and readvance the throttle.

2. Jettison external stores.

12.1.3. Engine power loss during flight – below 25,000 ft

If time and altitude permit engine acceleration from IDLE to the required rpm, attempt to regain engine power as follows:

1. Set the THROTTLE to IDLE.
2. Set the EMERGENCY FUEL SWITCH to ON.

Advance the throttle smoothly to the required rpm while keeping the exhaust temperature within limits. If the engine flames out, proceed with air start as time and altitude permit.

12.1.4. Engine air start

It is possible to restart the engine at altitudes up to 40,000 ft. Careful attention should be given to maximum engine windmilling speed. Exceeding the recommended windmilling speed may cause overtemperature operation with resultant engine damage.

Immediate Restart

At the first indication of a flame-out, attempt to relight the engine. Restarts are generally easier to accomplish while the engine is still hot and contains vapors. Immediate restarts are of prime importance during low-altitude flame-outs.

1. Set the THROTTLE to the OFF position.

2. Set the EMERGENCY IGNITION SWITCH to the ON position.
3. Set the EMERGENCY FUEL SWITCH to the ON position.
4. Set the THROTTLE to the OUTBOARD position then ADVANCE.
5. Set the EMERGENCY IGNITION SWITCH to OFF at 90% rpm.

Air Start

If time and altitude permit, the following procedure should be used:

1. Set the THROTTLE to the OFF position.
2. Establish glide with an IAS of 185 knots. The glide should be done with gear and flaps up and speed brakes in for maximum distance (see [12.1.5](#)).

Warning. At normal gliding speeds, engine windmilling does not provide adequate generator output making the battery the only source of electrical power. With the engine master switch, radio, pitot heater, and lights turned off, the battery can supply power for only 7 to 28 minutes (approximately). If engine damage prevents windmilling (causing normal hydraulic system pressure failure), the automatic operation of the alternate hydraulic pump will quickly drain battery power.

3. Check ENGINE MASTER SWITCH, generator, and battery-starter switches are ON.
4. Check RPM is within limits (23% to 34%). Up to 200 knots IAS may be required to obtain desired rpm.

Caution. Excessive rpm (above 35%) may cause an overtemperature condition by providing excessive fuel flow due to increased fuel pump capability (Not implemented in the simulation).

5. Set the EMERGENCY IGNITION SWITCH to ON.
6. Set the EMERGENCY FUEL SWITCH to ON.

NOTE. If flame-out was caused by too rapid a throttle movement, do not turn on the emergency fuel system unless the main system has actually failed. Starts made with the main fuel system in operation have a greater chance of success.

7. Set the THROTTLE to OUTBOARD then ADVANCE. Advance the throttle smoothly to the required rpm while keeping exhaust temperature within limits.

Caution. If there is no indication of fuel ignition after 30 seconds, pull the throttle to the OFF position and set the emergency ignition switch to OFF. Level the airplane to permit fuel drainage and repeat the starting procedure.

8. Set the EMERGENCY IGNITION SWITCH to OFF.

If the engine fails to start and time and altitude permit, attempt further air starts using either fuel system.

Caution. Ignition transformers may be damaged if the emergency ignition switch is left ON for more than 3 minutes per start.

12.1.5. Maximum glide

For maximum glide distance with engine windmilling or frozen, the optimum gliding speed is 185 knots IAS with gear and flaps up, speed brakes in, and no external load. When speed is maintained at 185 knots IAS, glide ratio and rate of descent with various airplane configurations can be determined from [Table 12.1](#).

Table 12.1

Airplane configurations	Glide ratio	Rate of descent
Gear and flaps up, speed brakes in	14 to 1	2,700 fpm at 40,000 ft 1,500 fpm at 10,000ft
Gear down, flaps up, speed brakes in	7.3 to 1	3,000 fpm at 10,000ft
Gear down, flaps up, speed brakes out	4.8 to 1	4,500 fpm at 10,000 ft

12.2. Fire

12.2.1. Engine fire during take-off

Illumination of the forward fire warning light during take-off indicates a fire in the forward engine section, necessitating immediate action. Illumination of the aft fire warning light indicates an overheat condition or possible fire in the aft section. The exact procedure to follow will vary with each set of circumstances and will depend upon altitude, airspeed, length of runway, overrun clearing remaining, availability of arresting barrier, location of populated areas, etc.

12.2.2. Fire while airborne

If either fire warning light comes on while the plane is airborne and there is insufficient runway and clear overrun available to abort the take-off, the following procedure is recommended:

1. Jettison external stores.

2. Set power to maximum and climb to a safe ejection altitude.
3. If aircraft is ON fire, EJECT.
4. If aircraft is not on fire, adjust throttle to minimum practical power and land as soon as possible. If existence of fire cannot be confirmed, maintain a safe ejection altitude at minimum practical power. Establish controllability of the airplane and try to obtain assistance from other airplanes in the area in determining existence of fire. If no assistance is available, reconfirm controllability before descent below safe ejection altitude and land as soon as possible.

12.2.3. Engine fire during flight

If either fire warning light comes on, proceed as follows:

1. Set THROTTLE to IDLE.
2. If aircraft is ON fire, EJECT. A fire can be determined by a report from another airplane, abnormal instrument readings, lack of response to flight or engine controls, explosions, unusual noise, vibration, fumes, heat, cockpit smoke, or trailing smoke observed during a turn.
3. If aircraft is not on fire, land as soon as possible using minimum practical power.

12.3. Flight control hydraulic system failure

In case of failure of the flight control normal hydraulic system, the alternate hydraulic system will automatically take over (provided there is adequate alternate system pressure available) as indicated by illumination of the ALTERNATE-ON warning light. If the normal system fails in flight, satisfactory control of the airplane can be maintained with the flight control alternate hydraulic system. The only limitations of the alternate system are that prolonged excessive control movement is limited because the capacity of the alternate system pump is less than that of the normal system pump.

12.3.1. Failure of the normal system

Do not fly close formation, perform aerobatics, or engage in unnecessary low-altitude flying. If the flight control normal hydraulic system fails in flight, proceed as follows:

1. Select the ALTERNATE SYSTEM if change-over is not automatic. This is done by unlocking and pulling the EMERGENCY OVERRIDE HANDLE out to its fully extended position. This is especially important when there is a complete failure of the flight control normal hydraulic system (i.e. system will not deliver 1000 PSI) and you are about to enter the traffic pattern.

Warning. When the emergency override handle is pulled out, the alternate system pump is engaged and operates continuously, regardless of system pressure. If generator output is not available, the pump will deplete battery power in approximately 6 to 7 minutes.

NOTE. This action will ensure continuous use of the flight control alternate hydraulic system and thus prevent cycling from the alternate system to the failed normal system which could result in momentary freezing of the controls during the landing phase.

Change-over from the normal to the alternate flight control hydraulic system is momentary and usually not noticeable although a slight surge or “nibble” may be felt on the stick during the change-over.

2. Check the ALTERNATE SYSTEM pressure.
3. Land as soon as possible.

12.3.2. Failure of both hydraulic systems

If both flight control hydraulic systems fail, movement of the control stick will not result in the corresponding surface movements. Under such conditions, control of the airplane in cruising flight becomes very difficult and control at high speeds or during extreme maneuvers is impossible. Extended flight or a landing should not be attempted under any circumstances.

If both hydraulic systems fail and no control of the aircraft can be maintained, EJECT immediately.

However, if a minimal amount of control is available:

1. Attempt to reduce airspeed to 200 knots IAS.
2. Maintain control, if possible, through the use of rudder, speed brakes, wing flaps, and landing gear, and by varying power as necessary. Attempt to neutralize the ailerons and horizontal stabilizers by steady push or pull forces on the stick, allowing air loads to streamline the surfaces.
3. If possible, steer the aircraft to a safe altitude and airspace and eject.

12.4. Landing gear emergency operation

Emergency Lowering

If a safe landing-gear-down indication is not obtained after several attempts using the normal procedure, the emergency landing gear lowering procedure should be used:

1. Hold airspeed below the gear-down limit speed (155 to 160 knots IAS is recommended).
2. Pull and hold extended the [GEAR EMERGENCY RELEASE HANDLE](#) to lower gear.

Caution. The nose gear cannot be retracted after being lowered by means of the landing gear emergency release handle.

12.5. Trim failure

A reasonably light control force would be required to neutralize the controls in case any of the trim systems should fail in either extreme travel position. Also, movement of the controls to the opposite extreme of travel would not be beyond a pilot's normal physical capabilities.

The normal trim switch on the stick grip is subject to sticking in an actuated position resulting in extreme trim. When this occurs in flight, the switch should be returned manually to the center (OFF) position after the desired amount of trim is obtained.

In case of failure of the normal trim switch, check that all circuit breakers are in. If the normal trim switch is still inoperative, use the longitudinal alternate trim switch and lateral alternate trim switch, as necessary, to obtain the desired trim result.



13

HOW TO PLAY

13. HOW TO PLAY

[To Important Notice](#)

13.1. General information

This game is a first-person aircraft simulation where the player controls an F-86 jet fighter by reading instruments and interacting with cockpit objects through the keyboard, mouse, and various other game controllers (joysticks, rudder pedals, touchpads, etc.).

The simulation gives the player the unique opportunity to control the airplane in real-time in much the same way a real pilot does. Besides interacting with cockpit controls, the player must give a significant amount of attention to what's happening in the world around them. This applies to every stage of the flight – from engine start-up to taxiing to the parking spot after landing. In addition, there are scenarios where the player must interact with and give orders to wingmen.

The game can be played in either single-player mode (the player is alone in the simulated world and everything else is controlled by the AI) or in multiplayer mode (several human players are connected via the internet while the rest of the objects are controlled by the AI). Depending on game and mission settings, several different external cameras are available to view objects in the simulated world, from a camera that allows you to see an external view of your aircraft to one where you can step through all the ground vehicles.

When a module is purchased, it has to be installed and activated as a module in DCS World. The main documents which describe the activation procedure, the main window functions, the game settings, the mission editor, and the setup of game controllers are located in the "Doc" folder inside the game installation directory. The documents are as follows:

- a) [DCS World Activation Guide EN.pdf](#) – describes how to install and activate the game;
- b) [DCS User Manual EN.pdf](#) – describes the main game interface and mission editor functionality;
- c) [DCS World Input Controller Walk Through EN.pdf](#) – explains how to setup game controllers;

- d) [DCS World List of all available Beacons EN.pdf](#) – lists the radio equipment and beacons at the airfields.

The DCS: F-86F simulation can only be played as part of a mission within the DCS World environment. Some missions come with the purchase of the F-86F. However, the user also has the option of downloading additional 3rd party missions from the internet or even building their own missions using the MISSION EDITOR (ME) tools. The user can even play a campaign – a series of related missions where mission success determines how far you progress. Like missions, campaigns can either be built by the user or downloaded from the internet. For an extra challenge, the user can try their hand at multiplayer. The mission editor, campaign builder, and multiplayer are all described in the [DCS User Manual EN.pdf](#) document.

Interaction between player and virtual cockpit

Inside the cockpit, the player can **control the aircraft, cockpit objects, and virtual pilot head position** (where the pilot is looking). This can be done through the keyboard only, the mouse, the joystick, or through a combination of controllers (ex. pressing the keyboard's Shift key can be used to alter the function of a joystick button). It is recommended that a joystick be used to actually fly the aircraft for the best possible game experience.

The mouse can be used in the following two modes:

- to control various objects in the clickable cockpit;
- to control the virtual pilot head position (view control, "mouse view").

The player can switch between these two modes at any time by pressing the keyboard combination [\[LAlt + C\]](#) or by double-clicking the mouse wheel.

13.2. Built-in missions

The game comes with a set of built-in missions which include training missions, instant action missions, and single missions. Non-training missions require the player to already be familiar with the airplane and willing to try a scenario on his own.

Procedure for starting a built-in mission:

1. Start DCS World. While in the main menu, select to fly either a training mission by selecting TRAINING or a regular mission by selecting INSTANT ACTION or MISSION:

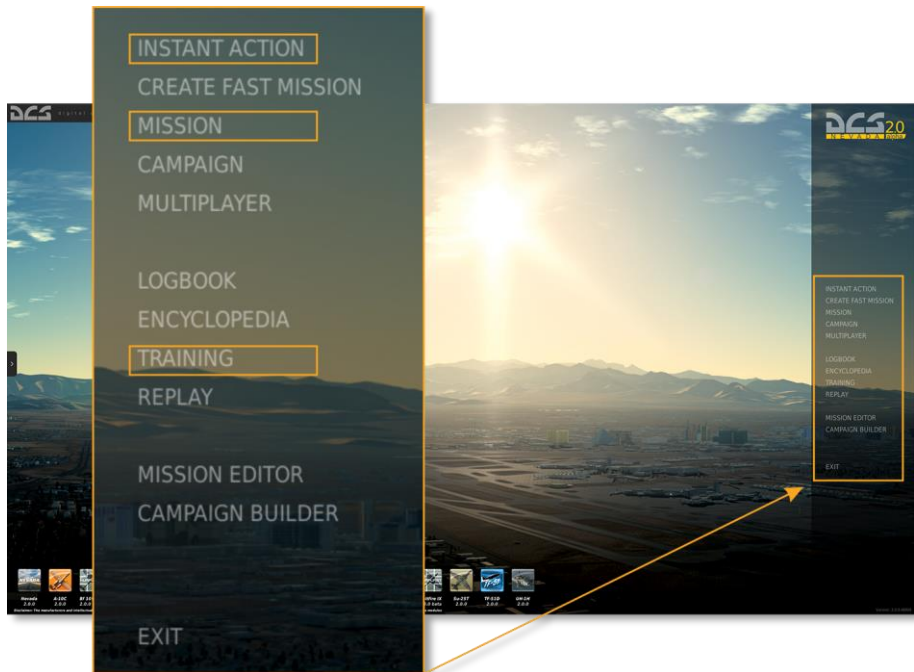

2. To choose a mission, first select the desired module from the left-hand menu and then pick a mission from the corresponding folder (the example below contains the folders "Taining", "QuickStart" and "Single"):

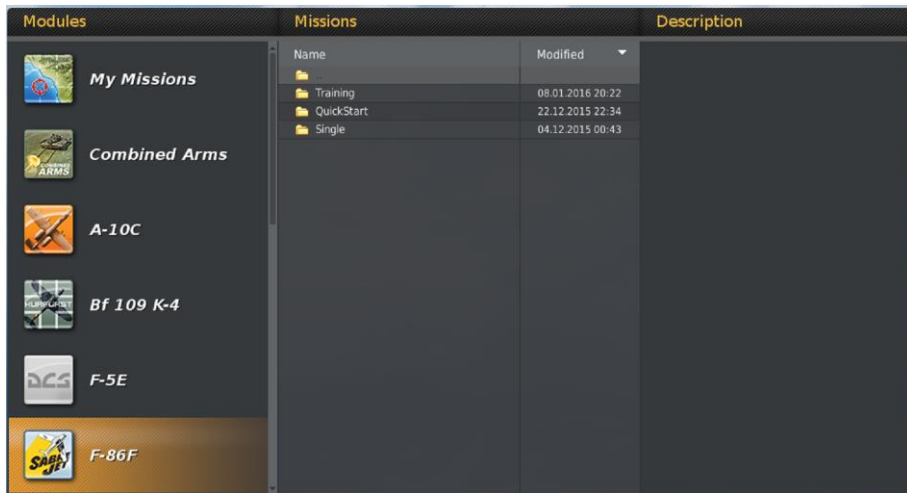

3. When the mission has been selected, a briefing window will appear. To fly the mission, click the START button at the bottom of the window:

Details

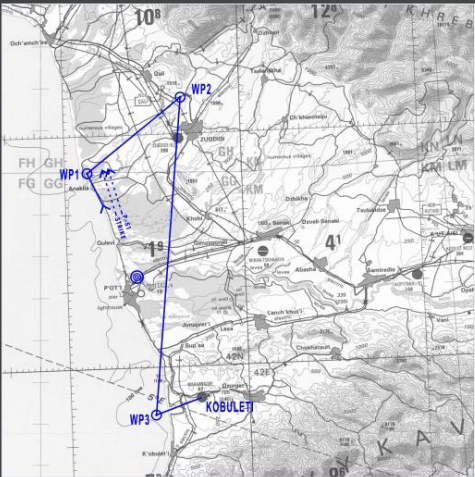

MISSION OVERVIEW

Title Flight Suit Attitude
 Start at 15/9/2011 09:36:00
 My Side USA
 Allies Australia - Belgium - Canada - Denmark - France - Georgia - Germany - Israel - Italy - Norway - Spain - The Netherlands - Turkey - UK - USA
 Enemies Abkhazia - Russia - South Ossetia - Ukraine

MISSION DATA

My task Fighter Sweep
 Flight F-86F*4
 Fuel 692(0)
 Weapon 'Fuel Tank 120 gallons*2

ALLIES FLIGHT

Allies flight 'P-51D'*4

SITUATION

September 15th, 1952

Take the role of Robinson Risner as you lead an escort mission for a Mustang ground attack strike. Orbit the Mustang flight as it attacks ground targets and protect it from MiGs.

Mid-way through their top cover, the flight runs into a fight



13.3. Controlling the airplane and various cockpit objects

The airplane is controlled by means of the control stick, throttle, and pedals. The stick is used to control roll (rotation around the axis running from nose to tail) and pitch (rotation around the axis running from wing to wing causing the nose to move up or down). A roll (or bank) is the first step when initiating a turn whereas pitch is used for diving and climbing. The throttle handle is used to control engine power (thrust) when it is necessary to increase or decrease airspeed. The pedals are used to control yaw (rotation around the vertical axis causing the nose to move left or right) and to compensate for sliding. Attached to, but independent of, the rudders are the wheel brakes which are used to slow the aircraft down on the ground.

13.3.1. Controlling the airplane with the joystick



The diagram above illustrates how roll and pitch can be controlled by the joystick. Many joysticks also come with a throttle axis in the form of a handle or a rotating knob to control engine power. In addition, some joysticks come with a twist axis for controlling rudder pedals.

For displaying the positions of the individual flight controls, a controls indicator (shown below) can be enabled through the keyboard combination **[RCtrl +**

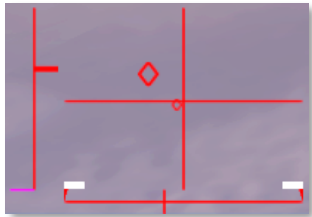

Enter]

13.3.2. Controlling the airplane with the keyboard

If the player is controlling the airplane using only the keyboard, the main control buttons are: arrow keys to control roll and pitch; **[Numpad+]** or **[Numpad-]** to control thrust; and **[Z]** or **[X]** to control the rudder pedals (see diagram below).

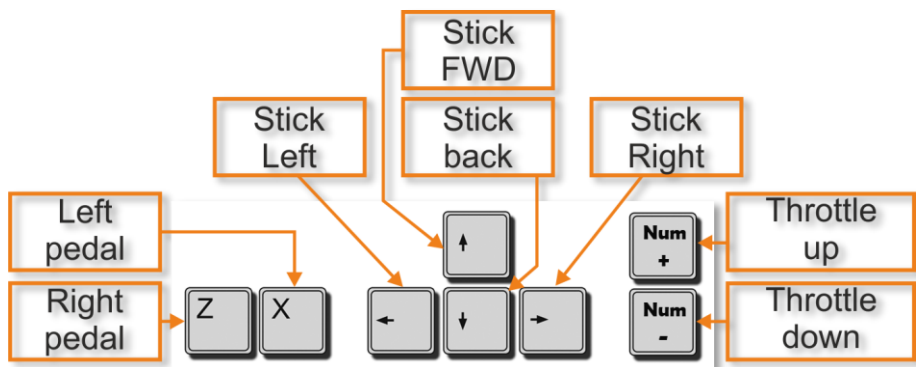

13.3.3. Interacting with cockpit objects with the mouse

All objects in the clickable cockpit can be controlled by the mouse through the left and right buttons and the mouse wheel. This "cockpit object control mode" is the default mouse mode in the game.

Normally, all switches are enabled by the left mouse button and disabled by the right. Cockpit objects which can be enabled or disabled with the mouse show the following symbol when the mouse pointer is over them:



The rotary switches (rotating knobs) rotate in one direction with the left mouse button and the other direction with the right. They can also be rotated with the mouse wheel. The cockpit objects which can be rotated show the following symbol when the mouse pointer is over them:



Holding the **[LShift]** button while rotating the mouse wheel will cause the knob to rotate 10 times faster.

13.4. Controlling virtual pilot head position and views in the 6DOF cockpit

13.4.1. Controlling virtual pilot head position in the 6DOF cockpit

The virtual pilot head can be moved along the three axes (OX, OY, OZ), and rotated around these axes ([Figure 13.1](#)).

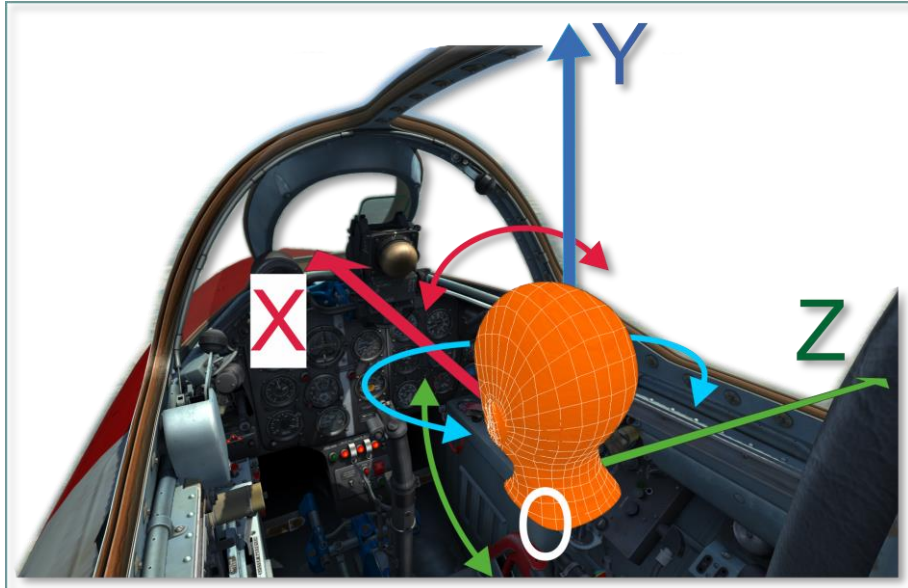







Figure 13.1. Axes in the 6DOF cockpit

Most head positions may be controlled by all input devices: keyboard, mouse, joystick, and head tracking devices such as TrackIR. However, the virtual head rotation around the OX axis (red colored curved arrow) is not often used which is why it can't be controlled through the keyboard or mouse.

In addition to head movement and rotation, there is also a zoom feature (cockpit view angle reduction). Through the zoom feature, objects inside and outside of the cockpit can be made to display larger. However, this also narrows the field of view and reduces what you can actually observe around you.





Head movement, rotation, and zooming with keyboard and mouse

Mouse wheel usage legend:

	Click and hold the mouse wheel
	Double click the mouse wheel
	Click and hold the mouse wheel while rotating it
	Rotate the mouse wheel
	Head movement along the corresponding axis
	Head rotation around the corresponding axis

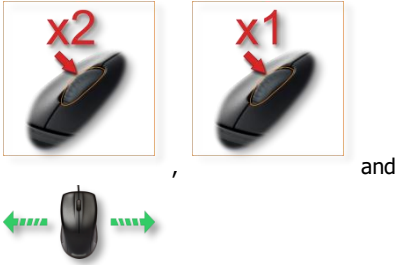
By default, the mouse is in *COCKPIT OBJECT CONTROL MODE*. To switch it to *VIRTUAL PILOT HEAD POSITION CONTROL MODE* (and back), use the key combination **[LAlt + C]** or **perform a double click of the mouse wheel**.

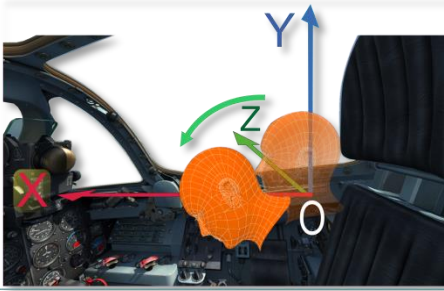
Action	Implementation by keyboard and mouse
	<p>Implementation by keyboard and mouse</p> <p>With keyboard: [RCtrl + RShift + *] or [RCtrl + RShift + /]</p> <p>With mouse:</p>
	<p>With keyboard: [RCtrl + RShift + Num2] or [RCtrl + RShift + Num8]</p> <p>With mouse:</p> <p>and</p>
	<p>With keyboard: [RCtrl + RShift + Num4] or [RCtrl + RShift + Num6]</p> <p>With mouse:</p>

	 <p>and</p>
	<p>With keyboard: [Num4] or [Num6]</p> <p>With mouse:</p> 
	<p>With keyboard: [Num2] or [Num8]</p> <p>With mouse:</p> 



13.4.2. Controlling views in the 6DOF cockpit

Many cockpit objects are located inconveniently (in niches covered by other objects). To be able to quickly look at the correct object in flight and return to the instrument panel, the built-in **SnapView** function can be used using key combinations. This function "remembers" custom views created by the player and allows the views to be activated through key combinations on the numeric keyboard. After the custom views are stored, they can be activated through the key combination [Num0 (modifier) + Num1...9 (one of 9 custom views)].

Before creating individual custom views, the player is encouraged to review the pre-defined default views by pressing [Num0 + Num1...9] in succession. In many cases, the default views are sufficient for the player's needs.

To create a custom SnapView:

- a) Activate the view you wish to modify by simultaneously pressing [Num0] and one of the keys [Num1...9].
- b) Set up the view as needed. View adjustments can be done with standard keyboard commands for controlling the camera:
 - [Num*] – zoom in slow;

- [Num/] – zoom out slow;
 - [RShift + RCtrl + Num2] – move cockpit camera down;
 - [RShift + RCtrl + Num8] – move cockpit camera up;
 - [RShift + RCtrl + Num4] – move cockpit camera left;
 - [RShift + RCtrl + Num6] – move cockpit camera right;
 - [Num1...9] – rotate the current point of view ([Num5] – center view);
 - [RShift + RCtrl + Num*] – move cockpit camera forward;
 - [RShift + RCtrl + Num/] – move cockpit camera back;
 - [RShift + RCtrl + Num2,8,6,4] – move cockpit camera to the center of the selected object;
 - [Num2,8,6,4] – turn the sight axis to the desired angle;
 - [*] or [/] – zoom in or out respectively.
- c) Store the adjusted view to a file by pressing the key combination [RAIt + Num0 + Num1...9].

Information about custom views is stored in the file

"C:\Users\<<USERNAME>\Saved Games\DCS\Config\View\SnapViews.lua".

13.5. Special game settings

Special game settings are located under the tab shown below.



LANDING SEAT ADJUSTMENT – enables the pilot's head to be automatically lifted during take-off and landing for better visibility

GUN CAMERA MODE – causes the gun camera film to display each time the gun is fired

NOSEWHEEL STEERING SIMPLE BEHAVIOUR – enables a simplified and less realistic implementation of the Nosewheel Steering System

CUSTOMIZED COCKPIT – allows a cockpit language and skin to be selected

NOSEWHEEL STEERING SIMPLE BEHAVIOUR (description).

This is checked by default to give simplified behavior of the nosewheel steering. When in this mode, only the NWS button has to be pressed to engage nosewheel steering. This is unrealistic because the positions of the nose wheel and rudder pedals do not play a role in engaging the NWS system. When the NWS button is pressed, the nose wheel is "automatically synchronized" with rudder pedal position.

If unchecked, the NWS system works realistically. That is, to engage the NWS system, the NWS button has to be pressed and the rudder pedals must be aligned in the direction the nose wheel is turned, i.e. the nose wheel has to be "caught" with the rudder pedals for synchronization. When the nose wheel and rudder pedals are coordinated in this manner, the nose wheel steering unit is automatically engaged. Note that the wheel can be in a position outside of rudder pedal authority and can not be caught at all. The nose wheel unit will not engage if the nose wheel is more than 21° to either side of the center. Should the nose wheel be turned more than this, it must be brought into the steering range by use of the wheel brakes.

13.6. Informational help to the player

To ease the learning process and help the player overcome inconveniences that a real pilot wouldn't have to face, kneeboards are available in the game.

13.6.1. Kneeboard

In addition to providing airport information and showing the pilot's flight route, the kneeboard shows the state of the most important systems in the aircraft as well as the key combinations to alter each system's state (see [Figure 13.2](#)).

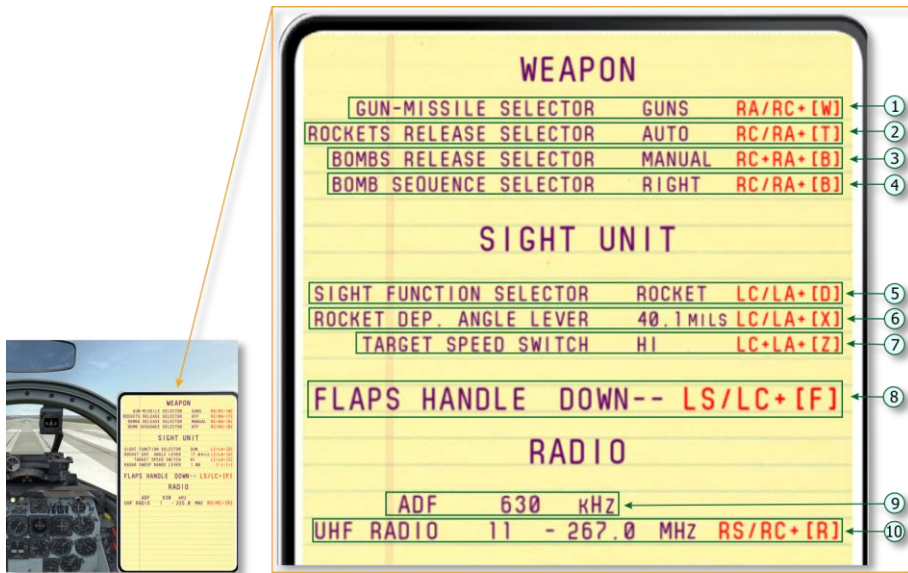

Figure 13.2. Kneboard informs player about the state of the aircraft's important systems (key combinations in red)

- | | |
|--|--|
| 1. Weapon: Gun-Missile Selector state and key command to change position | 8. Current flaps handle position |
| 2. Weapon: Rockets Release Selector state | 9. Radio: AN/ARN-6 current frequency |
| 3. Weapon: Bomb Release Selector state | 10. Radio: AN/ARC-27 current channel and frequency |
| 4. Weapon: Bomb Sequence Selector state | |
| 5. Sight Unit: Sight Function Selector state | |
| 6. Sight Unit: Rocket Depression Angle value | |
| 7. Sight Unit: Target Speed Switch state | |

Legend: RC=RCtrl, RA=RAIt, R=RShift, LC=LCtrl, LA=LAIt, L=LShift

The kneboard is activated either by pressing **[K]** (to temporarily show the kneboard while the key is kept pressed) or **[RShift + K]** (to toggle the keyboard permanently on or off).



14

**ABBREVIATIONS
AND TERMS**

14. ABBREVIATIONS AND TERMS

AC	Alternating Current
ACB	Automatic Circuit Breaker
ADF	Automatic Direction Finder
AGL	Above Ground Level
Ah	Amper x hour
AI	Artificial intelligence
ALT	Alternator
ALT	Altitude/Altimeter
ALTM	Altimeter
AM	Amplitude Modulation
AMP	Ampere
ANT	Antenna
ATTD	Attitude
AUTO	Automatic
AUX	Auxiliary
AVGAS	Aviation Gasoline
BAT	Battery
BDHI	Bearing Distance Heading Indicator
BFO	Beat Frequency Oscillator
BL	Butt Line
BRIL	Brilliance
BRT	Bright
C	Celsius
CARR	Carrier
CAS	Callibrated airspeed
CCW	Counter Clockwise
CDI	Course Deviation Indicator
CG	Center of Gravity
CL	Centerline

CMPS	Compass
CNVTR	Converter
COLL	Collision
COMM	Communication
COMPT	Compartment
CONT	Control
CONT	Continuous
CONV	Converter
CW	Clockwise
DC	Direct Current
DCP	Dispenser Control Panel
DECR	Decrease
deg	degree
DELTA A	Incremental Change
DET	Detector
DF	Direction Finding
DG	Directional Gyro
DIS	Disable
DISP	Dispense
DSCRM	Discriminator
ECM	Electronic Countermeasures
EGT	Exhaust Gas Temperature
ELEC	Electrical
EMER	Emergency
END	Endurance
ENG	Engine
ESS	Essential
EXH	Exhaust
EXT	Extend
EXT	Exterior
F	Fahrenheit

FAT	Free Air Temperature
FCU	Fuel Control Unit
FITG	Fitting
FM	Frequency Modulation
FOD	Foreign Object Damage
fpm	feet per minutes
FPS	Feet Per Second or Frame Per Second
FREQ	Frequency
FS	Fuselage Station
ft	feet
ft/min	Feet Per Minute
ft-in	feet&inch
FUS	Fuselage
FWD	Forward
G	Gravity
gal	Gallon
GD	Guard
GEN	Generator
GND	Ground
GOV	Governor
GPU	Ground Power Unit
GRWT	Gross Weight
GW	Gross Weight
HDG	Heading
HF	High Frequency
HIT	Health Indicator Test
HS	Hydraulic systems
HTR	Heater
HVAR	High Velocity Aircraft Rocket
HYD	Hydraulic
Hz	Herz

IAS	indicated air speed
IAS	Indicated Airspeed
ICS	Interphone Control Station
IDENT	Identification
IFF	Identification Friend or Foe
IGE	In Ground Effect
in	Inch
INCR	Increase
IND	Indication/Indicator
INHG	Inches of Mercury
INOP	Inoperative
INST	Instrument
INT	Internal
INT	Interphone
INV	Inverter
INVTR	Inverter
IR	Infrared
IRT	Indicator Receiver Transmitter
ISA	International Standard Atmosphere
KCAS	Knots Calibrated Airspeed
kHz	Kilohertz
KIAS	Knots Indicated Airspeed
km	Kilometer
kN	Kilonewton
knots	Nautical Miles per hour
kp	Kilogram-force
KTAS	Knots True Airspeed
kVA	Kilovolt-Ampere
kW	kiloWatt
kW	Kilowatt
L	Left

LABS	Low-altitude bombing system
lbf	pound-force
lbs	Pounds
LClick	Left (button) Click Mouse
LDG	Landing
LH	Left Hand
LSB	Lower Sideband
LT	Lights
LTG	Lighting
LTS	Lights
MAG	Magnetic
MAN	Manual
MAX	Maximum
MED	Medium
MHF	Medium-High Frequency
MHz	Megahertz
MIC	Microphone
mil	millirad, 1\6400 part of a circle
MIN	Minimum
MIN	Minute
MISC	Miscellaneous
mm	Millimeter
MON	Monitor
MPC	Manual pip control
MWO	Modification Work Order
N1	Gas Turbine Speed
N2	Power Turbine Speed
NAV	Navigation
NET	Network
NM	Nautical Mile
nm	Nautical Mile

NO	Number
NON-ESS	Non-Essential
NON-SEC	Non-Secure
NORM	Normal
NR	Gas Turbine Speed
NVG	Night Vision Goggles
NWS	Nosewheel Steering (system or mechanism)
OGE	Out of Ground Effect
PED	Pedestal
PLT	Pilot
PRESS	Pressure
PRGM	Program
PSI	Pounds Per Square Inch
PVT	Private
PWR	Power
QTY	Quantity
R	Right
R/C	Rate of Climb
R/D	Rate of Descent
RCLICK	Right (button) Click Mouse
RCVR	Receiver
RDR	Radar
RDS	Rounds
REL	Release
REM	Remote
RETR	Retract
RETRAN	Retransmission
RF	Radio Frequency
RH	Right Hand
RI	Remote Height Indicator
RPM	Revolutions Per Minute

SAM	Surface to Air Missile
SEC	Secondary
SEC	Secure
SEL	Select
SENS	Sensitivity
SL	Searchlight
SOL	Solenoid
SQ	Squelch
SQFT	Square Feet
SSB	Single Sideband
STA	Station
STBY	Standby
T/R	Transmit-Receive
TAS	True Airspeed
TEMP	Temperature
TGT	Turbine Gas Temperature
TRANS	Transfer
TRANS	Transformer
TRANS	Transmitter
TRQ	Torque
UHF	Ultra-High Frequency
USB	Upper Sideband
V	Volt
VAC	Volts, Alternating Current
VDC	Volts, Direct Current
VHF	Very high Frequency
VM	Volt Meter
VNE	Velocity, Never Exceed (Airspeed)
VOL	Volume
VOR	VHF Omni Directional Range
WL	Water line

WPN	Weapon
XCVR	Transceiver
XMIT	Transmit
XMSN	Transmission
XMTR	Transmitter
ΔF	Increment of Equivalent Flat Plate Drag Area

15. THE METRIC SYSTEM AND EQUIVALENTS, CONVERSION FACTORS

15.1.1. The Metric System and Equivalents

Linear Measure

1 centimeter = 10 millimeters = .39 inch
1 decimeter = 10 centimeters = 3.94 in
1 meter = 10 decimeters = 39.37 in
1 dekameter = 10 meters = 32.8 ft
1 hectometer = 10 dekameters = 328.08 ft
1 kilometer = 10 hectometers = 3,280.8 ft

Weights

1 centigram = 10 milligrams = .15 grain
1 decigram = 10 centigrams = 1.54 grains
1 gram = 10 decigram = .035 ounce
1 decagram = 10 grams = .35 ounce
1 hectogram = 10 decagrams = 3.52 ounces
1 kilogram = 10 hectograms = 2.2 pounds
1 quintal = 100 kilograms = 220.46 pounds
1 metric ton = 10 quintals = 1.1 short tons

Liquid Measure

1 centiliter = 10 milliliters = .34 fl. ounce
1 deciliter = 10 centiliters = 3.38 fl. ounces
1 liter = 10 deciliters = 33.81 fl. ounces
1 dekaliter = 10 liters = 2.64 gallons
1 hectoliter = 10 dekaliters = 26.42 gallons
1 kiloliter = 10 hectoliters = 264.18 gallons

Square Measure

1 sq. centimeter = 100 sq. millimeters = .155 sq. inch
1 sq. decimeter = 100 sq. centimeters = 15.5 sq. in
1 sq. meter (centare) = 100 sq. decimeters = 10.76 sq. ft
1 sq. dekameter (are) = 100 sq. meters = 1,076.4 sq. ft
1 sq. hectometer (hectare) = 100 sq. dekameters = 2.47 acres
1 sq. kilometer = 100 sq. hectometers = .386 sq. mile

Cubic Measure

1 cu. centimeter = 1000 cu. millimeters = .06 cu. inch
1 cu. decimeter = 1000 cu. centimeters = 61.02 cu. in
1 cu. meter = 1000 cu. decimeters = 35.31 cu. ft

15.1.2. Approximate Conversion Factors

To change (imperial)	To (metric)	Multiply by
in	centimeters	2.540
ft	meters	.305
yards	meters	.914
miles	kilometers	1.609
knots	km/h	1.852
square in	square centimeters	6.451
square ft	square meters	.093
square yards	square meters	.836
square miles	square kilometers	2.590
acres	square hectometers	.405
cubic ft	cubic meters	.028
cubic yards	cubic meters	.765
fluid ounces	milliliters	29,573
pints	liters	.473
quarts	liters	.946
gallons	liters	3.785
ounces	grams	28.349
pounds	kilograms	.454
short tons	metric tons	.907
pound-ft	Newton-meters	1.356
pound-in	Newton-meters	.11296
ounce-in	Newton-meters	.007062
(metric)	(imperial)	
centimeters	in	.394
meters	ft	3.280
meters	yards	1.094
kilometers	miles	.621
km/h	knots	0.54
square centimeters	square in	.155
square meters	square ft	10.764
square meters	square yards	1.196
square kilometers	square miles	.386
square hectometers	acres	2.471
cubic meters	cubic ft	35.315
cubic meters	cubic yards	1.308
milliliters	fluid ounces	.034
liters	pints	2.113
liters	quarts	1.057



liters	gallons	.264
grams	ounces	.035
kilograms	pounds	2.205
metric tons	short tons	1.102



"Enchant by realism!"

belsimtek



16

DEVELOPERS

16. DEVELOPERS

BELSIMTEK

MANAGEMENT

Alexander "PilotMi8" Podvoyskiy
Alexander "Foxhound_vva"

Project and QA Manager, technical documentation
Module project manager

PROGRAMMERS

Vladimir "cofcorpse" Timoshenko
Alexander "Alan Parker"
Nikolay Volodin
Alexey "Alex Wolf"
Andrey Kovalenko
Alexander Mishkovich

Nikolay T

Konstantin "btd" Kuznetsov

Lead programmer
Flight dynamics
Engine systems
Power plant, engine systems
Avionics, weapons
Systems of aircraft, avionics, effects, damage model
Aircraft performance coordination
Sound developer, music composer

DESIGNERS

Maxim Lysov
Pavel Sidorov
Timur Cygankov
Andrey Reshetko
Igor Piskunov

Alexandr Drannikov

3D-model of aircraft
Damage model
3D-model of cockpit
Pilots
2D-complicated schemes and chapters cover design of manual
Graphics resources for site

SCIENCE SUPPORT

Sergey "Vladimirovich"

modeling methodology

TESTER STAFF

Alexander "BillyCrusher" Bilievskiy
Dmitry "Laivynas" Koseliov
Edin "Kuky" Kulelija
Erich "ViperVJG73" Schwarz
Evan "Headspace" Hanau
Ivan "Frogfoot" Makarov
Nikita "Nim" Opredelekov
Oleg "Dzen" Fedorenko
Raul "Furia" Ortiz de Urbina
Roberto "Vibora" Seoane Penas
Scott "BIGNEWY" Newnham
Stephen "Nate" Barrett
Valery "Rik" Khomenok
Werner "derelor" Siedenburg
Xueqian "Uboats" Zhao

TRAINING

Vyacheslav "SL PAK" Paketny

Training missions

SPECIAL THANKS

Werner "derelor" Siedenburg

For professionalism and
thoroughness in editing this manual
For help in testing and debugging of
the aircraft systems

Alan "NightRush" Shafto
(aviation engineer including
F-86 Sabres)

Grayson "graywo1fg" Frohberg

For recording the training mission
voice-overs

F-86A

HANDLING CHARACTERISTICS

LECTURE DIGEST



N O R T H A M E R I C A N A V I A T I O N , I N C .



17

BIBLIOGRAPHY AND SOURCES

17. BIBLIOGRAPHY AND SOURCES

1. Handbook maintenance instructions USAF SERIES F-86F AIRCRAFT, TO No 1F-86F-2 (Formerly 01-60JLD-2), November 1953
2. Flight Manual USAF SERIES F-86F AIRCRAFT, CONTRACT AF33(038)-14801, AF04(606)-15753, May 1960 (Change – April 1971)
3. Теория авиационных двигателей, часть 1, и 2 Учебник для ВУЗов ВВС/ Под ред. Ю. Н. Нечаева – М: ВВИА им. проф. Н.Е. Жуковского, 2006 – 448с .
4. Конструкция и прочность авиадвигателей. Учебное пособие/ Под ред. А. И. Евдакимова – М: ВВИА им. проф. Н.Е. Жуковского, 2007 – 340 с.
5. Сиротин Н.Н. Конструкция и эксплуатация, повреждаемость и работоспособность газотурбинных двигателей. М: РИА "ИМ-информ",2002.
6. Конструкция и проектирование авиационных газотурбинных двигателей. / Под ред. Д. В. Хронина. – М: Машиностроение, 1989.
7. Mark D. Jane's aero-engines. – Alexandria, Virginia 22314, US: Jane's information Group inc, 2009. – 448 с.
8. С.М. Егер "Проектирование самолетов"
9. К.П. Петров "Аэродинамика элементов летательных аппаратов"
10. "Аэродинамика, устойчивость и управляемость сверхзвуковых самолётов" под ред. Г.С. Бюшгенса
11. R. Chambers, S. Grafton "Aerodynamics of airplanes at high angles-of-attack"